

MADE IN ITALY

Pavé Brick

16,5x41 - 8x41

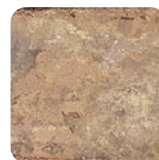

GRES PORCELLANATO
PORCELAIN STONEWARE . GRÈS CÉRAME . FEINSTEINZEUG



Pavé Brick

INDOOR

16,5x41 / 8x41

OUTDOOR

16,5x41
R11 A+B

GRES PORCELLANATO
PORCELAIN STONEWARE . GRÈS CÉRAME . FEINSTEINZEUG

richenia
ECCELLENZA CERAMICA ITALIANA

Pareti in mattoni e
pavimenti consumati
dal tempo.

Pavé Brick

Atmosfere calde entrano

Pareti in mattoni e pavimenti consumati dal tempo.

Atmosfere calde entrano con stile negli spazi contemporanei.

Interni ed esterni rivelano con coerenza il fascino delle imperfezioni e dei colori di superfici antiche che Sichenia traduce in Gres porcellanato.

Soluzioni equilibrate e stimoli creativi si adattano ai canoni estetici del momento sia come espressione ricercata in contrasto alla modernità che come autentico effetto vintage.

fascino delle imperfezioni
e dei colori di superfici
antiche.

Brick walls and floors aged by time.

Warm atmospheres bring style to contemporary spaces.

Indoor and outdoor spaces harmoniously reveal the charm of imperfections and of the colours of ancient surfaces, recreated by Sichenia in porcelain stoneware.

Balanced solutions and creative solutions adapt to the current aesthetic standards offering a refined yet modern mood and lending an authentic vintage effect.

Des murs de briques et des sols usés par le temps.

Des atmosphères chaudes pénètrent avec style dans les espaces contemporains.

L'intérieur et l'extérieur révèlent avec cohérence le charme des imperfections et des couleurs des surfaces anciennes que Sichenia traduit en grès cérame.

Des solutions équilibrées et des stimuli créatifs s'adaptent aux standards esthétiques du moment, à la fois comme une expression raffinée s'opposant à la modernité et comme un authentique effet vintage.

Ziegelwände und Böden, die mit der Zeit gealtert sind.

Moderne Räume erhalten eine besondere Atmosphäre und einen unvergleichlichen Stil.

Sichenia vereint die antike Anmutung und die scheinbare Unvollkommenheit der

Oberflächen in einem modernen Feinsteinzeug.

Höchste ästhetische Maßstäbe im Vintage- Effekt harmonieren einzigartig im Kontrast

zur heutigen Modernität.

vintage.



Tante facce differenti per comporre superfici inimitabili.

Many different faces for inimitable surfaces.

De nombreuses facettes différentes pour composer des surfaces inimitables.

Verschiedene Größen, um verschiedene Charaktere widerzuspiegeln.

40

16,5x41



80

8x41



Pavé Brick

Espressioni chic di ispirazione urbana

Urban-inspired chic living.

Des expressions chics d'inspiration urbaine.

Ein geerdetes Lebensgefühl in der eigenen Komfortzone.



Rivestimento . Wall tile:
Pavé Brick Naturale 8x41

Pavimento . Floor:
Collection Block - Mud 60x60

Pavé Brick

Eleganza e personalità nelle tue atmosfere domestiche

Elegance and personality create the
atmospheres in your home.

L'élégance et la personnalité de vos
atmosphères domestiques.

Gemütlichkeit und Klasse
in den eigenen vier Wänden.

Rivestimento - Wall tile:
Pavé Brick Sbiancato 8x41

Pavimento - Floor:
Collection Nature Plus - Nocciola 20x120

Pavé Brick

Dove un assaggio muove profondi ricordi

Where smells and tastes rekindle deep memories.

Où un aperçu fait affleurer de profonds souvenirs.

Wo Geruch und Geschmack schöne Erinnerungen wecken...

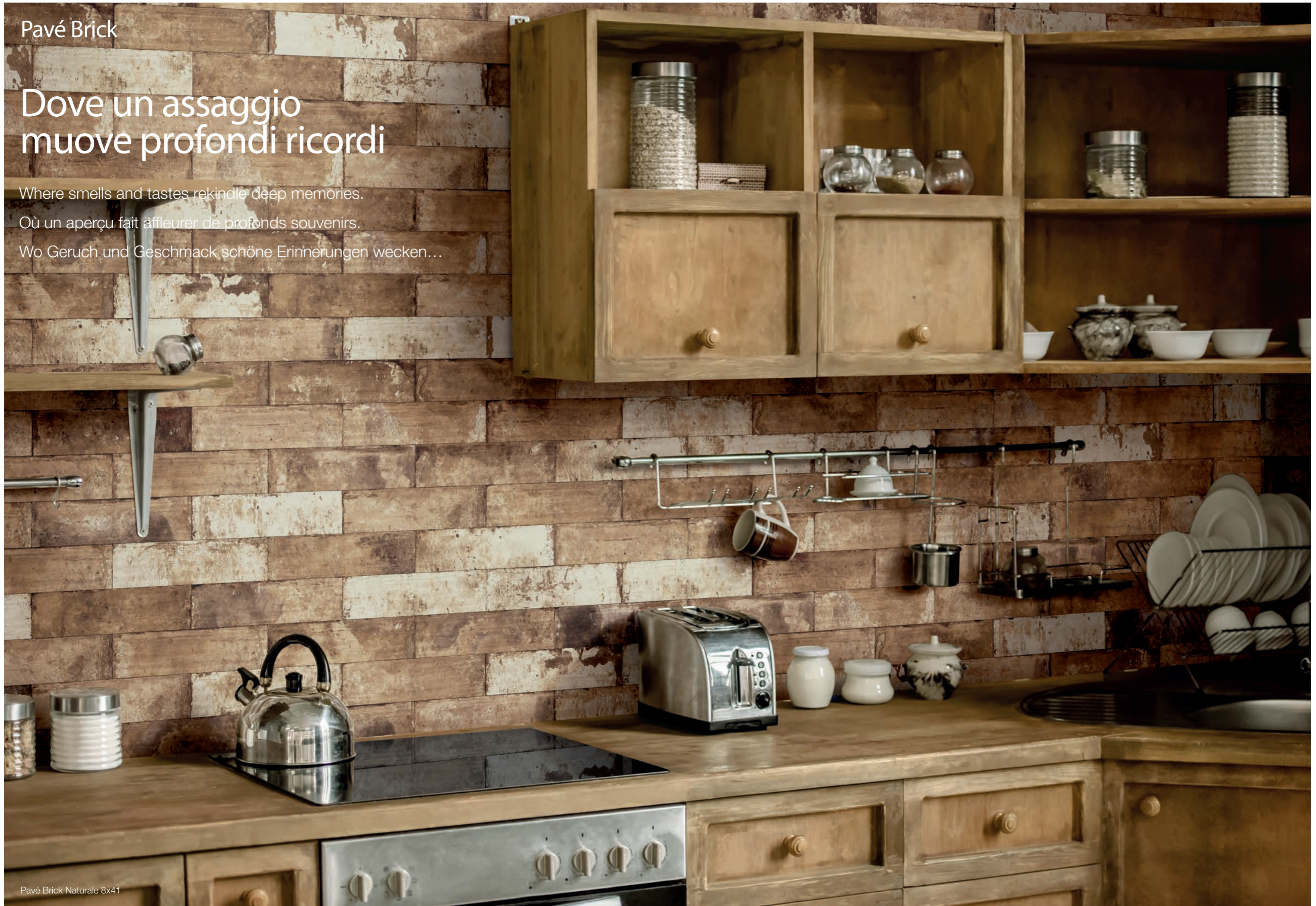

Pavé Brick Naturale 8x41

Pavé Brick

Una buona spolverata di tradizione con qualche pizzico di design

A good sprinkling of tradition
and a few pinches of design.

Un peu de tradition avec
une pincée de design.

Traditionell und dennoch zeitnah.



Pavé Brick

Intimamente connesso al tuo modo di essere

Intimately connected to
your way of being.

Intiment lié à votre
façon d'être.

In Verbindung mit den
Wünschen der Seele nach
Geborgenheit.



Rivestimento . Wall tile:
Pavé Brick Sbiancato 8x41

Pavimento . Floor:
Collection Essenze - Noce 20x120

Pavé Brick

Contrasti creativi tra elementi del passato e stile contemporaneo

Creative contrast between past features
and contemporary style.

Des contrastes créatifs entre des éléments
du passé et un style contemporain.

Moderne & Tradition
kontrastreich vereinigt.

Pavé Brick

Quel look retrò assolutemante di classe

That absolutely classy
retro look.

Ce look rétro d'une très
grande classe.

Der stilvolle Retrolook.



Rivestimento . Wall tile:
Pavé Brick Naturale 8x41

Pavimento . Floor:
PHORMA: Collection Stone Selection - Meera 60x60

Pavé Brick

Superfici informali e accoglienti per ambienti dedicati all'ospitalità

Informal and cosy surfaces for
spaces dedicated to conviviality.

Des surfaces informelles et
accueillantes pour des espaces
dédiés à l'hospitalité.

Auch in Hotels oder Restaurants
versprüht dieser Stil Behaglichkeit
und Entschleunigung.

Rivestimento . Wall tile:
Pavé Brick Cotto 8x41

Pavimento . Floor:
PHORMA: Collection Essenze - Rovere 20x120

Pavé Brick

Un aspetto rustico, che fa tendenza.

A rustic and fashionable look.

Un aspect rustique qui fait la mode.

Rustikal, aber trotzdem am Puls der Zeit.



A PROVA DI MACCHIA.

Stain proof.
Il est antitache.
Fleckenabweisend.



INALTERABILE DAI PRODOTTI PER LA PULIZIA.

The characteristics are not affected by the use of cleaning products.
Les produits de nettoyage ne l'altèrent pas.
Unangreifbar für Putzmittel.



FACILE DA PULIRE

Easy to clean.
Facile à nettoyer.
Leicht zu reinigen.

Rivestimento . Wall tile:
Pavé Brick Naturale 8x41

Pavimento . Floor:
Pavé Brick Naturale16,5x41



Pavé Brick

Un effetto scenico suggestivo inserito tra antiche mura e nuovi progetti.

A charming effect that blends ancient walls and new projects.

Un effet scénique suggestif inséré entre d'anciens remparts et de nouveaux projets.

Die perfekte Symbiose zwischen „Alt“ und „Neu“.



MANTIENE L'ASPETTO ORIGINALE NEL TEMPO.

Maintains its original appearance over time.
Il garde son aspect d'origine dans le temps.
Behält das ursprüngliche Aussehen langfristig bei.

R11
A+B

Pavé Brick Cotto 16,5x41

Pavé Brick

Dove esterni e interni possono essere una sola superficie continua

Indoor and outdoor surfaces meet in a
single visual space.

Où l'extérieur et l'intérieur peuvent
constituer une seule surface continue.

Durchgehende Innen- und
Aussenbereiche geben immer ein
Gefühl der Weite.

INDOOR - Pavimento . Floor:
Pavé Brick Cotto 16,5x41

OUTDOOR - Pavimento . Floor:
Pavé Brick Cotto 16,5x41
Pavé Brick Cotto Elemento a L. 15x30

R11
A+B

Pavé Brick

Armonie estetiche tra materiali e habitat circostante

Materials in harmony with the surrounding habitat.

Des harmonies esthétiques entre les matériaux et l'habitat environnant.

Integration in Harmonie mit den umliegenden Gegebenheiten.



R11
A+B

Pavé Brick Sbiancato 16,5x41

Pavé Brick

Concetti evoluti per rivestire pareti esposte all'esterno

Innovative concepts for outdoor walls.

Des concepts évolués pour habiller les murs exposés à l'extérieur.

Außenfassaden in ihren schönsten Anmutungen.



RESISTE AL GELO E AGLI SBALZI TERMICI.
Resistant to frost and sudden temperature changes.
Il résiste au gel et aux écarts thermiques.
Gegen Frost und Temperaturschwankungen beständig.



NON ASSORBE L'ACQUA.
Water repellent.
Il n'absorbe pas l'eau.
Nimmt kein Wasser auf.



Muri e muretti a regola d'arte

Perfectly created walls.

Des murs et des murets dans les règles de l'art.

Perfekt und stilsicher verkleidete Wände.



INATTACCABILE DA MUFFE.

Resistant to moss.
Il résiste à l'agression des moisissures.
Schimmelbeständig.

**PRESENTA LA CARATTERISTICA DI "IMPUTRESCIBILITÀ"
IN OGNI CONDIZIONE DI UTILIZZO.**

Rot-resistant in all conditions of use.
Présente la caractéristique d'être imputrescible dans toute condition
d'utilisation.
Weist die Eigenschaft der "Fäulnisfreiheit" unter allen
Einsatzbedingungen auf.

**TOTALMENTE INERTE RISPETTO ALLA CONTAMINAZIONE
E PROLIFERAZIONE DI MICRO-ORGANISMI.**

100% hygienic and anti-bacterial.
Totalement inerte par rapport à la contamination et à la prolifération
de microorganismes.
Vollkommen unempfindlich in Bezug auf die Verunreinigung und die
Ausbreitung von Mikroorganismen.



Per camminare in totale sicurezza

Walking in total safety.

Pour marcher en toute sécurité.

Neue Wege, die mit ästhetischen Komfort
und optischer Schönheit zum spazieren
einladen.

R11
A+B



RESISTE AL CALPESTIO PERSISTENTE.
Resistant to persistent foot traffic.
Il résiste au piétinement persistant.
Beständig gegen kontinuierliche Begehung.



16,5x41 | 8x41
6¹/₂x16⁷/₁₆ | 3⁵/₃₂x16⁷/₁₆



16,5x41 |
6¹/₂x16⁷/₁₆



indoor

indoor: Rivestimento e pavimento . Floor and Wall tile
outdoor: Rivestimento . Wall tile

outdoor

SBIANCATO



180261 - 16,5x41 50



180271 - 8x41 55



180281 - 16,5x41 50

NATURALE



180262 - 16,5x41 50



180272 - 8x41 55

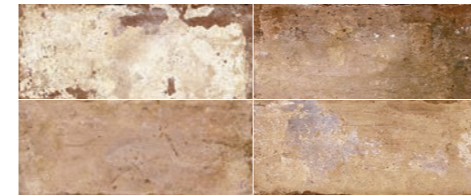

180282 - 16,5x41 50

COTTO

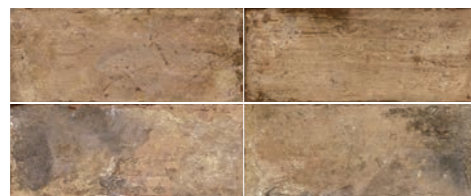

180263 - 16,5x41 50



180273 - 8x41 55

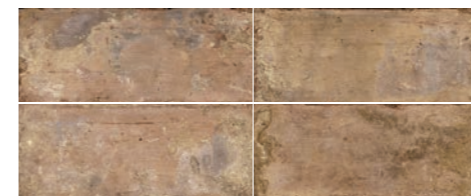

180283 - 16,5x41 50

PEZZI SPECIALI

Special pieces .
Pièces spéciales .
Spezialteile .

Battiscopa
7x41 15

180291 - Sbiancato
180292 - Naturale
180293 - Cotto



Elemento a "L"
15x30 54

180301 - Sbiancato
180302 - Naturale
180303 - Cotto

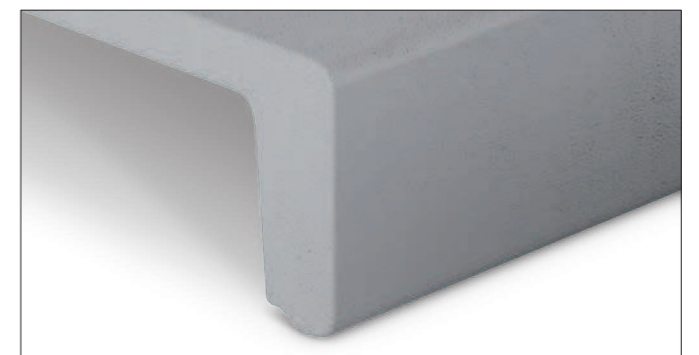
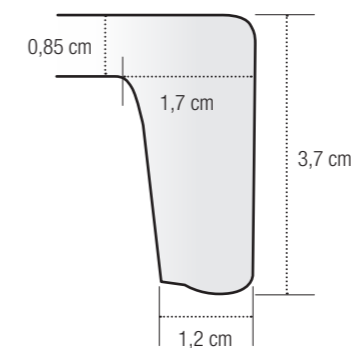
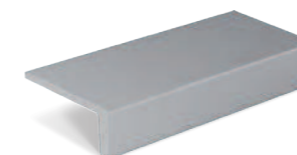

IMBALLI

Weights and pack . Poids et emballages . Gewicht und Verpackung

FORMATI Sizes . Formats . Formate	Pz x	m² x	kg x	x	m² x	kg x
16,5x41	16	1,082	22,775	48	51,955	1095
8x41	22	0,722	16,925	60	43,296	1018
7x41 Battiscopa	12	0,344	7,517	65	22,386	489
15x30 Elemento a L	8	0,360	9,074	52	18,72	495

CARATTERISTICHE TECNICHE DI SUPERFICIE

Technical surface properties . Caractéristiques techniques des surfaces . Technische Eigenschaften der Oberfläche

	 Resistenza alle macchie (Pulibilità). Resistance to staining. Résistance aux produits tachants. Beständigkeit gegen. ISO 10545/14	 Resistenza agli acidi e alle basi. Resistance to acids and bases. Résistance aux acides et aux bases. Beständigkeit gegen Säuren und Laugen. ISO 10545/13	 Scivolosità. Slipperiness. Glissance. Rutschgefahr. B.C.R.A.		 Scivolosità. Slipperiness. Glissance. Rutschgefahr. DIN 51130 DIN 51097		 Scivolosità. Slipperiness. Glissance. Rutschgefahr. DCOF Ansi A 137.1.2012
			Cuoio asciutto	Gomma bagnata	R	ABC	
outdoor 16,5x41	5	A . LA . HA	> 0,40	> 0,40	R11	A + B	> 0,42 Wet
indoor 16,5x41 . 8x41	5	A . LA . HA	> 0,40	> 0,40	R10	A	> 0,42 Wet



PAVÉ BRICK è un prodotto realizzato con la tecnologia digitale di Sichenia.

Sichenia Digital Technology è un avanzato procedimento di produzione che consente un incredibile realismo nella realizzazione di superfici in gres porcellanato; prova ne sono l'elevato numero di variazioni grafiche ottenibili e la sorprendente precisione nella riproduzione dei minimi particolari della materia naturale.

Sichenia sceglie ancora una volta l'avanguardia della tecnologia disponibile per conferire il massimo grado di ricercatezza al design ed alle prestazioni della proprie collezioni.

PAVÉ BRICK is a product manufactured using Sichenia's digital technology.

Sichenia Digital Technology is an advanced manufacturing process that enables incredible realism in the production of porcelain stoneware tiles; proof of this lies in the large number of graphic variations obtainable and the astonishing fidelity with which the smallest detail of the natural material is reproduced.

Sichenia has once again the chosen cutting-edge technology available to lend its collection the utmost sophistication in design and performance.

PAVÉ BRICK est un produit réalisé suivant la technologie numérique de Sichenia.

Sichenia Digital Technology est un processus avancé qui permet un réalisme incroyable en réalisant des surfaces en grès cérame ; le grand nombre de variations graphiques réalisables et la précision surprenante au niveau de la reproduction des moindres détails de la matière naturelle en sont la preuve.

Sichenia choisit une fois de plus l'avant-garde de la technologie disponible pour empreindre le design et les performances de ses collections du plus haut degré de raffinement.

PAVÉ BRICK ist ein mit der Sichenia-Digitaltechnologie geschaffenes Produkt.

Die Sichenia Digital Technology ist ein fortschrittliches Produktionsverfahren, das eine unglaubliche Wirklichkeitstreue bei der Herstellung von Oberflächen aus Feinsteinzeug ermöglicht. Beweis dafür sind die hohe Zahl von erzielbaren graphischen Varianten sowie die überraschende Genauigkeit bei der Nachbildung der kleinsten Details des Materials aus der Natur.

Sichenia entscheidet sich erneut für die fortschrittliche, verfügbare Technologie, um dem Design und den Leistungen ihrer Kollektionen eine besondere Auserlesenheit zu verleihen.

DESTINAZIONI D'USO CONSIGLIATE

Examples of applications suggested . Domaines d'utilisation conseillés . Empfohlene Anwendungsbereiche.

Ville, Casali, Rustici, Appartamenti, Negozi, Uffici, Ristoranti, Bar.

Villas, Country houses, Farmhouses, Apartments, Shops, Offices, Restaurants, Bars.

Villas, Maisons de campagne, Fermes, Appartements, Magasins, Bureaux, Restaurants, Cafés.

Häuser, Farmhäuser, Bauernhäuser, Wohnungen, Geschäfte, Büros, Restaurants, Cafés.

INTERNI

Soggiorno, Cucina, Bagno, Sale da pranzo, Corridoi, Camere da letto, Sala ricevimento.

INDOOR

Living Rooms, Kitchens, Bathrooms, Dining rooms, Corridors, Bedrooms, Reception rooms.

INTÉRIEURS

Salles de séjour, Cuisines, Salles de bains, Salles à manger, Couloirs, Chambres à coucher, Salles de réception.

INNENBEREICHE

Wohnzimmer, Küche, Badezimmer, Esszimmer, Korridore, Schlafzimmer, Empfangsräume.

ESTERNI R11 A+B

Terrazze, Balconi, Verande, Porticati, Passaggi pubblici in sicurezza.

OUTDOOR R11 A+B

Terraces, Balconies, Verandas, Porches, Safe road crossings.

EXTÉRIEURS R11 A+B

Terrasses, Balcons, Vêrandas, Porches, Des passages publics sécurisés.

AUSSENBEREICHE R11 A+B

Terrassen, Balkons, Veranden, Laubengänge, Öffentliche Schutzwege.



La riproduzione, la pubblicazione, e la distribuzione, totale o parziale, di tutto il materiale originale contenuto in questo documento sono espressamente vietate in assenza di autorizzazione da parte di Sichenia. Sichenia si riserva di modificare i prodotti senza preavviso, declinando ogni responsabilità relativa a danni diretti o indiretti derivanti da tali modifiche. I colori e le caratteristiche estetiche dei materiali illustrati nel presente catalogo sono da ritenersi puramente indicativi. Per le informazioni e i dati relativi ai codici, imballaggi e pesi occorre sempre consultare l'ultimo listino aggiornato e in vigore.

The reproduction, publication, and distribution, total or partial, of all the original material contained herein is expressly prohibited without the prior consent of Sichenia. Sichenia reserves the right to make changes to the products without notice, and shall not be liable for any direct or indirect damages arising from any changes. The colours and the aesthetic characteristics of the products shown in this catalogue are purely illustrative. For information and data concerning codes, packaging and weight always refer to the last updated price list in force.

La reproduction, la publication et la distribution, totales ou partielles, de tout le matériel original contenu dans ce document sont expressément interdites sans l'autorisation de Sichenia. Sichenia se réserve la faculté de modifier les produits sans préavis, en déclinant toute responsabilité relative à des dommages directs ou indirects dérivant d'éventuelles modifications. Les couleurs et les caractéristiques esthétiques du matériel illustré dans ce catalogue sont fournis à titre purement indicatif. Pour les informations et les données relatives aux codes, aux emballages et aux poids, il est toujours nécessaire de consulter le dernier tarif mis à jour et en vigueur.

Die vollständige oder auszugsweise Vervielfältigung, Veröffentlichung und Verbreitung des gesamten, in diesem Dokument enthaltenen Originalmaterials, ist ohne Genehmigung der Firma Sichenia ausdrücklich untersagt. Sichenia behält sich das Recht vor, die Produkte ohne vorherige Ankündigung zu ändern und haftet nicht für direkte oder indirekte, durch eventuelle Änderungen verursachte Schäden. Die Farben und ästhetischen Merkmale des im vorliegenden Katalogs abgebildeten Materials sind rein zur Information und nicht bindend. Für Informationen zu den Daten der Codenummern, Verpackungen und Gewichten siehe immer die neuste, jeweils gültige Preisliste.

"Sichenia" è un brand italiano che produce pavimenti e rivestimenti in ceramica pensati per l'architettura contemporanea. Una gamma di prodotti di grande pregio estetico e resistenza, ottenuti con materie prime di alta qualità modellate dall'estro progettuale italiano.

"Sichenia" is an Italian brand that manufactures ceramic wall and floor coverings designed for contemporary architecture. It offers a range of products with high aesthetic quality and resistance, obtained with high quality raw materials shaped with Italian design flair.



Sichenia è da sempre concretamente impegnata nella tutela dell'ambiente.

Utilizza processi produttivi e tecnologie all'avanguardia che riducono notevolmente l'impatto ambientale delle attività in ogni fase esecutiva, dalla progettazione all'imballaggio finale del prodotto.

Sichenia has always been actively involved in safeguarding the environment.

It adopts avant-garde production processes and technologies that significantly reduce the environmental impact of each execution phase, from design to the final packaging of the product.

Pavé Brick



Sichenia Gruppo Ceramiche S.p.A.

Via Toscana, 12 - 41049 Sassuolo (Modena, Italy)

Tel. +39 0536.81.84.11 - Fax Italia +39 0536.81.01.05 / export +39 0536.80.08.15

info@sichenia.it - www.sichenia.it