

HOME

COLLECTIONS 2026



HOME

COLLECTIONS 2026

INDEX . SOMMAIRE . INHALTSVERZEICHNIS

ABOUTUS	002
STONEPIETRE	082
MARBLEMARMI	160
CONTEMPORARYCONTEMPORANEO	178
WOODLEGNI	226
SPESSORATI 1.4/2.0	252
INFOTECH	262
PACKINGLIST	294
94_EVO	190
AMBOISE	126
ARDENNES	084
AR_GENT	140
ART BY SICHENIA Industrial	204
BLOCK	214
CHATEAUX	146
CHANTILLY	098
CON_CRETE	180
COPICO	174
CREMA LUNA	104
LA THUILE	228
ME_TAL	210
MYSTONE	092
NAVONA	162
P_ARKETT	232
PAVÉ BRICK	222
PAVÉ DELLE ALPI	112
PAVÉ WALL 30,90	136
PAVÉ WALL DOLMEN	152
PAVÉ WALL HOUSE	156
PRESTIGE	166
PROGETTO S7	200
SILVIS	246
TRONÇAIS	242



L'AZIENDA

THE COMPANY . LA SOCIÉTÉ . DAS UNTERNEHMEN

Fondata negli anni Settanta, Sichenia è oggi una realtà di riferimento nel settore ceramico italiano, specializzata in pavimenti e rivestimenti in grès porcellanato.

La costante innovazione tecnologica e l'automazione dei processi hanno consolidato la crescita dell'azienda, che coniuga da sempre qualità, estetica e funzionalità nelle proprie collezioni.

Founded in the 1970s, Sichenia has become a benchmark in the Italian ceramic industry, specializing in porcelain stoneware floors and wall coverings.

Continuous technological innovation and advanced automation have driven the company's growth, combining quality, aesthetics, and functionality in every collection.

Fondée dans les années 1970, Sichenia est aujourd'hui une référence dans le secteur céramique italien, spécialisée dans les sols et les revêtements en grès cérame.

Grâce à une innovation technologique constante et à des procédés automatisés, l'entreprise allie depuis toujours qualité, esthétique et fonctionnalité dans chacune de ses collections.

Sichenia wurde in den 1970er-Jahren gegründet und zählt heute zu den führenden Marken der italienischen Keramikbranche.

Das Unternehmen hat sich auf Feinsteinzeug für Böden und Wände spezialisiert und verbindet dank fortschrittlicher Technologie und Automatisierung seit jeher Qualität, Ästhetik und Funktionalität in seinen Kollektionen.





004



005

RICERCA, SVILUPPO & QUALITA'

RESEARCH & DEVELOPMENT . RECHERCHE ET DÉVELOPPEMENT . FORSCHUNG UND ENTWICKLUNG.

Il reparto R&D è il cuore dell'innovazione Sichenia. Attraverso ricerca continua e processi produttivi all'avanguardia, l'azienda realizza materiali che uniscono design, prestazioni tecniche e sostenibilità.

Ogni prodotto garantisce sicurezza, igiene e durata, confermando l'impegno verso la qualità totale.

Sichenia's R&D department is the driving force behind its innovation. Through continuous research and advanced production processes, the company develops materials that combine cutting-edge design, technical performance, and sustainability.

Every product ensures safety, hygiene, and durability, reflecting Sichenia's commitment to total quality.

Le département R&D de Sichenia est au cœur de son innovation. Grâce à une recherche constante et à des procédés de production avancés, l'entreprise conçoit des matériaux alliant design, performances techniques et durabilité.

Chaque produit garantit sécurité, hygiène et longévité, témoignant de l'engagement de Sichenia envers la qualité totale.

Die F&E-Abteilung von Sichenia ist das Herzstück der Innovation. Durch kontinuierliche Forschung und moderne Produktionsverfahren entwickelt das Unternehmen Materialien, die Design, technische Leistungsfähigkeit und Nachhaltigkeit vereinen.

Jedes Produkt steht für Sicherheit, Hygiene und Langlebigkeit und unterstreicht das umfassende Qualitätsversprechen von Sichenia.



MADE IN ITALY

L'eccellenza italiana in ogni superficie.

Per Sichenia, il Made in Italy è una filosofia produttiva basata su creatività, competenza e passione. Ogni collezione nasce da materie prime selezionate, design raffinato e rispetto per l'ambiente e le persone. È l'espressione autentica di un saper fare che unisce tradizione e innovazione.

Italian excellence in every surface.

For Sichenia, Made in Italy is more than a label—it's a way of working, rooted in creativity, expertise, and passion. Each collection is crafted from carefully selected materials, refined design, and a commitment to people and the environment. It reflects the authentic Italian know-how, where tradition meets innovation.

L'excellence italienne à chaque surface.

Pour Sichenia, le Made in Italy n'est pas qu'un label : c'est une philosophie de production fondée sur la créativité, le savoir-faire et la passion. Chaque collection est issue de matières premières soigneusement sélectionnées, d'un design raffiné et d'un engagement envers l'environnement et les personnes. C'est l'expression authentique d'un art italien qui allie tradition et innovation.

Italienische Exzellenz auf jeder Oberfläche.

Für Sichenia ist Made in Italy mehr als ein Label – es ist eine Produktionsphilosophie, die auf Kreativität, Kompetenz und Leidenschaft basiert. Jede Kollektion entsteht aus sorgfältig ausgewählten Materialien, elegantem Design und mit Respekt für Mensch und Umwelt. Sie verkörpert das authentische italienische Können, in dem Tradition und Innovation verschmelzen.





008



009

SOSTENIBILITÀ & AMBIENTE

SUSTAINABILITY AND ENVIRONMENT . DURABILITÉ ET ENVIRONNEMENT . NACHHALTIGKEIT UND UMWELT.

Sichenia promuove una produzione eco-compatibile e circolare, riducendo consumi e sprechi.

Utilizza energia pulita e da cogenerazione, riciclo di materie prime e acque, smalti senza piombo e imballaggi riciclabili.

Sichenia is committed to a sustainable, circular production approach that minimizes waste and resource consumption.

It relies on clean, green and cogenerated energy, reuses raw materials and water, and employs lead-free glazes along with fully recyclable packaging.

Sichenia adopte un modèle de production durable et circulaire, conçu pour limiter au maximum l'usage des ressources et les pertes.

L'entreprise fonctionne avec des énergies propres et de cogénération, valorise le recyclage des matières premières et de l'eau, et utilise des émaux sans plomb ainsi que des emballages recyclables.

Sichenia setzt auf eine umweltfreundliche, kreislauforientierte Produktion, die den Verbrauch von Ressourcen und die Entstehung von Abfällen deutlich reduziert.

Das Unternehmen nutzt saubere und kraft wärme gekoppelte Energie, recycelt Rohstoffe und Wasser, verwendet bleifreie Glasuren und setzt auf recycelbare Verpackungen.



LE PERSONE AL CENTRO

PEOPLE AT THE HEART . LES PERSONNES AU COEUR .
DIE MENSCHEN IM MITTELPUNKT

Il vero valore di Sichenia risiede nelle persone che ogni giorno contribuiscono alla crescita dell'azienda.

Professionalità, competenza e spirito di squadra sono alla base di un ambiente di lavoro che favorisce collaborazione, creatività e sviluppo individuale.

Ogni persona è parte integrante del successo collettivo e del percorso di innovazione che caratterizza da sempre l'identità dell'azienda.

Sichenia's true strength lies in the people who contribute every day to the company's growth.

Professionalism, expertise, and teamwork form the foundation of a work environment that nurtures collaboration, creativity, and personal development.

Each individual plays a key role in the collective success and in the continuous innovation that defines Sichenia's identity.

La véritable richesse de Sichenia réside dans les personnes qui participent chaque jour au développement de l'entreprise.

Professionalisme, compétences et esprit d'équipe sont les piliers d'un environnement de travail favorisant la collaboration, la créativité et l'épanouissement individuel.

Chacun contribue au succès collectif et au parcours d'innovation qui fait l'identité de Sichenia.

Der wahre Wert von Sichenia liegt in den Menschen, die täglich zum Wachstum des Unternehmens beitragen.

Professionalität, Kompetenz und Teamgeist bilden die Basis eines Arbeitsumfelds, das Zusammenarbeit, Kreativität und persönliche Entwicklung fördert.

Jede Person ist ein wesentlicher Teil des gemeinsamen Erfolgs und des Innovationsprozesses, der die Identität von Sichenia prägt.

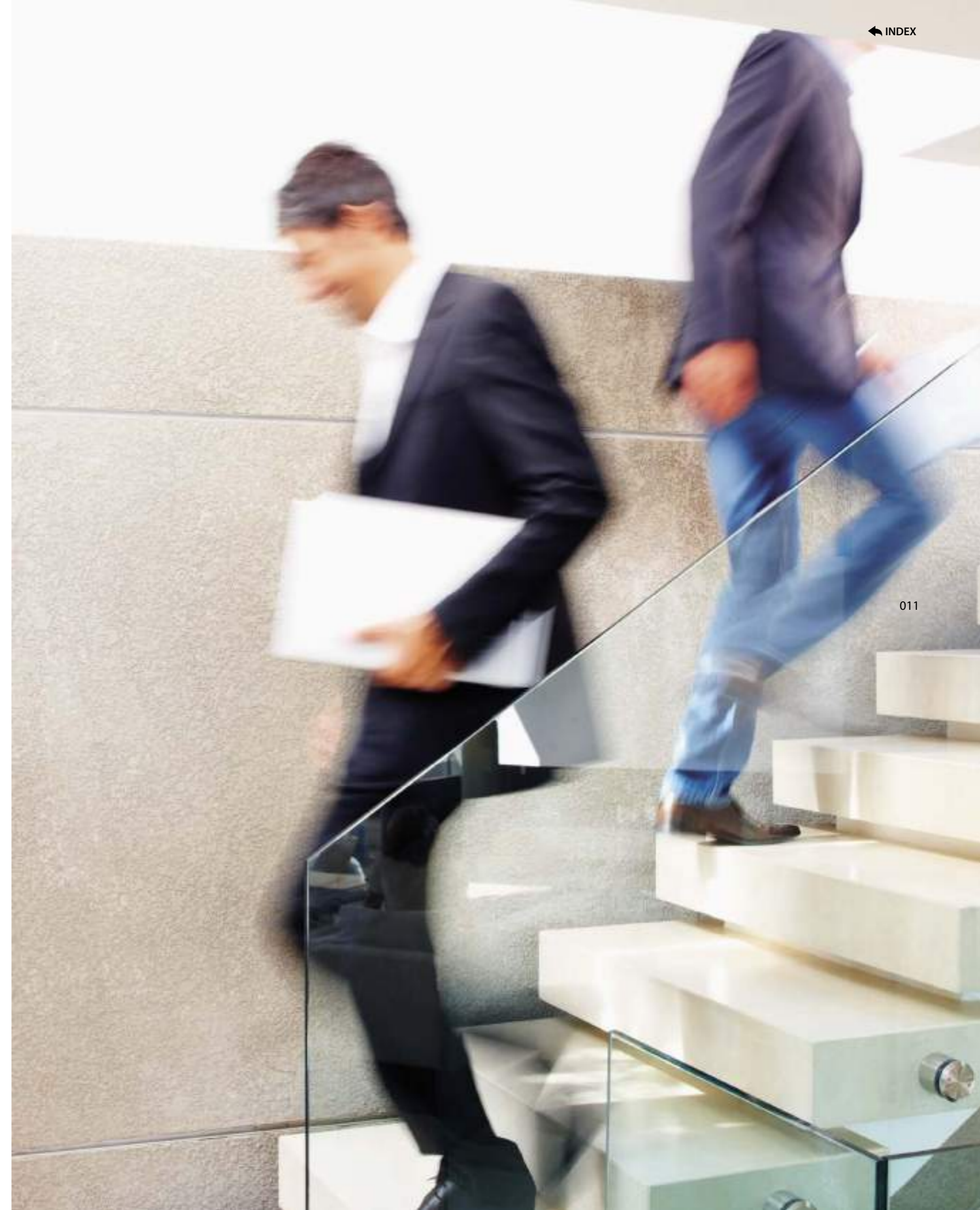

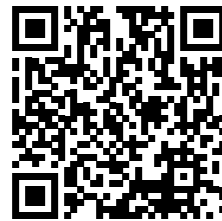

Iscriviti alla nostra Newsletter
Subscribe to our Newsletter



LinkedIn



Istagram

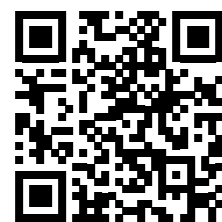

Facebook

SEGUICI OLTRE IL CATALOGO

FOLLOW US BEYOND THE CATALOG .
SUIVEZ NOUS AU-DELA' DU CATALOGE .
FOLGEN SIE UNUS UBER DEN KATALOG HINAUS

Resta connesso con Sichenia anche online! Scopri ispirazioni, novità e progetti direttamente sui nostri canali social. Scansiona i QR code e unisciti alla community: idee, tendenze e curiosità ti aspettano, ogni giorno, anche al di fuori di queste pagine.

Stay connected with Sichenia online! Explore inspirations, news, and projects directly on our social channels. Scan the QR codes and join our community—ideas, trends, and insights await you every day, even beyond the pages of this catalog.

Restez connecté avec Sichenia en ligne! Découvrez inspirations, nouveautés et projets directement sur nos réseaux sociaux. Scannez les QR codes et rejoignez notre communauté : idées, tendances et curiosités vous attendent chaque jour, au-delà de ces pages.

Bleiben Sie auch online mit Sichenia verbunden! Entdecken Sie Inspirationen, Neuigkeiten und Projekte direkt auf unseren Social-Media-Kanälen. Scannen Sie die QR-Codes und werden Sie Teil unserer Community – Ideen, Trends und Einblicke erwarten Sie täglich, weit über diese Seiten hinaus.





PALETTE CROMATICA

COLOR RANGE . NUANCIER. FARBPALETTE

Scopri l'ampiezza della gamma Sichenia attraverso il nostro abaco cromatico. Ogni immagine mostra i prodotti in tutte le tonalità disponibili, permettendoti di esplorare combinazioni, sfumature e materiali per dare forma a spazi unici e personalizzati.

Explore the full breadth of Sichenia's collection through our color chart. Each image showcases products in all available shades, allowing you to discover combinations, nuances, and materials to create unique, personalized spaces.

Découvrez l'étendue de la gamme Sichenia grâce à notre nuancier. Chaque image met en valeur les produits dans toutes les teintes disponibles, pour explorer combinaisons, nuances et matériaux et imaginer des espaces uniques et personnalisés.

Entdecken Sie die Vielfalt der Sichenia-Kollektion über unsere Farbpalette. Jede Abbildung zeigt die Produkte in allen verfügbaren Farbtönen und lädt dazu ein, Kombinationen, Nuancen und Materialien zu erkunden, um einzigartige, individuelle Räume zu gestalten.

STONEPIETRE

PAVIMENTIE RIVESTIMENTI | Floor and Wall tiles. | Sols et Murs. | Bodenfliesen und Wandfliesen.

PAVÉ DELLE ALPI Porfido	CHANTILLY Mélange de Nuit	CHANTILLY Beige	PAVÉ DELLE ALPI Sestriere	AMBOISE Oro	AMBOISE Beige	CREMA LUNA Beige	CHANTILLY Mélange
ARDENNES Ceam	CHANTILLY Crème	CREMA LUNA Cream	CHANTILLY Blanc	MYSTONE White	MYSTONE Silver	ARDENNES Nut	AR_GENT Greige
PAVÉ DELLE ALPI Piasentina	MYSTONE Sand	CHATEAUX Taupe	AR_GENT Cream	AMBOISE Bianco	ARDENNES Pearl	CREMA LUNA Pearl	CHATEAUX Bianco
PAVÉ DELLE ALPI Quarzo Grigio	PAVÉ DELLE ALPI Granito	PAVÉ DELLE ALPI Quarzo Multicolore	CRAMA LUNA Mist	AMBOISE Grigio	CRAMA LUNA Urban	CHATEAUX Antracite	AR_GENT Ash
ARDENNES Grey	PAVÉ DELLE ALPI Valmalenco	MYSTONE Black	PAVÉ DELLE ALPI Pietra Luserna				

RIVESTIMENTI | Wall tiles. | Murs. | Wandfliesen.

CREMA LUNA Tuscia Blend	PAVÉ DELLE ALPI Piasentina	PAVÉ DELLE ALPI Porfido	PAVÉ WALL DOLMEN Mattone	PAVÉ DELLE ALPI Sestriere	PAVÉ WALL 30X90 RIBBED Oro	PAVÉ WALL HOUSE Sabbia	PAVÉ WALL 30X90 RIBBED Beige
PAVÉ WALL DOLMEN Corda	PAVÉ WALL NAVONA Beige	CREMA LUNA Tuscia Cream	PAVÉ WALL 30X90 VELVET Cream	PAVÉ WALL DOLMEN Savana	PAVÉ WALL 30X90 ROWS Sunshine	PAVÉ WALL DOLMEN Bianco	CREMA LUNA Pearl
PAVÉ WALL 30X90 VELVET Calacatta Gold	PAVÉ WALL 30X90 ROWS Zebrino	PAVÉ WALL 30X90 RIBBED Bianco	PAVÉ WALL HOUSE Bianco	PAVÉ WALL NAVONA Bianco	PAVÉ WALL 30X90 ROWS White	PAVÉ WALL DOLMEN Fumo	PAVÉ DELLE ALPI Quarzo Multicolore
PAVÉ DELLE ALPI Pietra Luserna	PAVÉ DELLE ALPI Granito	PAVÉ DELLE ALPI Quarzo Grigio	PAVÉ WALL 30X90 VELVET Amazing Grey	PAVÉ WALL 30X90 RIBBED Grigio	PAVÉ WALL 30X90 VELVET Greige	PAVÉ WALL HOUSE Cenere	CREMA LUNA Mist
PAVÉ WALL HOUSE Muschio	PAVÉ WALL HOUSE Grafite	PAVÉ DELLE ALPI Valmalenco	PAVÉ WALL 30X90 VELVET Saint Laurent				



WOODLEGNI

PAVIMENTI E RIVESTIMENTI | Floor and Wall tiles. | Sols et Murs. | Bodenfliesen und Wandfliesen.

TRONÇAIS Bianco	TRONÇAIS Neutro	LA THUILE Pino	SILVIS Acero	LA THUILE Rovere	TRONÇAIS Miele	P_ARKETT Linz
SILVIS Rovere	TRONÇAIS Cognac	P_ARKETT Thun	LA THUILE Frassino	SILVIS Larice	P_ARKETT Tirolo	
P_ARKETT Graz	LA THUILE Doussié	SILVIS Mogano	SILVIS Noce	TRONÇAIS Duna	TRONÇAIS Sage	

MARBLEMARMI

PAVIMENTI E RIVESTIMENTI | Floor and Wall tiles. | Sols et Murs. | Bodenfliesen und Wandfliesen.

PRESTIGE Onix	PRESTIGE Dolomite	PRESTIGE Calacatta Gold	PRESTIGE Arabesque	PRESTIGE Palissandro	COPICO Grey	COPICO Blue	PRESTIGE Port Laurent
NAVONA Beige	PRESTIGE Travertine	NAVONA Bianco	COPICO Cream	COPICO Brown			

CONTEMPORARYCONTEMPORANEO

PAVIMENTI E RIVESTIMENTI | Floor and Wall tiles. | Sols et Murs. | Bodenfliesen und Wandfliesen.

94_EVO Bianco di Spagna	PROGETTO S7 Bianco	94_EVO Terra di Vicenza	CON_CRETE3 Bianco	PAVÉ BRICK Sbiancato	BLOCK Ice	BLOCK Powder	94_EVO Mica Perlata
94_EVO Grigio Cromo	CON_CRETE3 Grigio Cenere	BLOCK Mud	PROGETTO S7 Grigio	CON_CRETE3 Grigio Basalto	BLOCK Grey	ME_TAL Silver	BLOCK Graphite
CON_CRETE3 Antracite	94_EVO Nero Fumo	PROGETTO S7 Nero	ME_TAL Black	ME_TAL Dark Blue	PROGETTO S7 Blu	94_EVO Blu D'Egitto	PROGETTO S7 Verde
94_EVO Verde di Nicosia	ME_TAL Rust	94_EVO Terra Arabica	CON_CRETE3 Cappuccino	ME_TAL Pearl	CON_CRETE3 Beige	PAVÉ BRICK Naturale	94_EVO Terra d'Umbria
PROGETTO S7 Rosa	94_EVO Ocre del Morocco	PROGETTO S7 Ocre	PAVÉ BRICK Cotto	ME_TAL Corten			



ISPIRAZIONI

INSPIRATIONS . INSPIRATIONS . INSPIRATIONEN

Dove le superfici prendono vita.

Lasciati ispirare dalle nostre ambientazioni e scopri come le superfici Sichenia trasformano la tua casa in uno spazio unico e personale.

Where surfaces come to life.

Be inspired by our settings and discover how Sichenia surfaces can transform your home into a unique and personal space.

Là où les surfaces prennent vie.

Laissez-vous inspirer par nos ambiances et découvrez comment les surfaces Sichenia transforment votre maison en un espace unique et personnel.

Wo Oberflächen zum Leben erwachen.

Lassen Sie sich von unseren Rauminzenierungen inspirieren und entdecken Sie, wie Sichenia-Oberflächen Ihr Zuhause in einen einzigartigen und persönlichen Raum verwandeln.

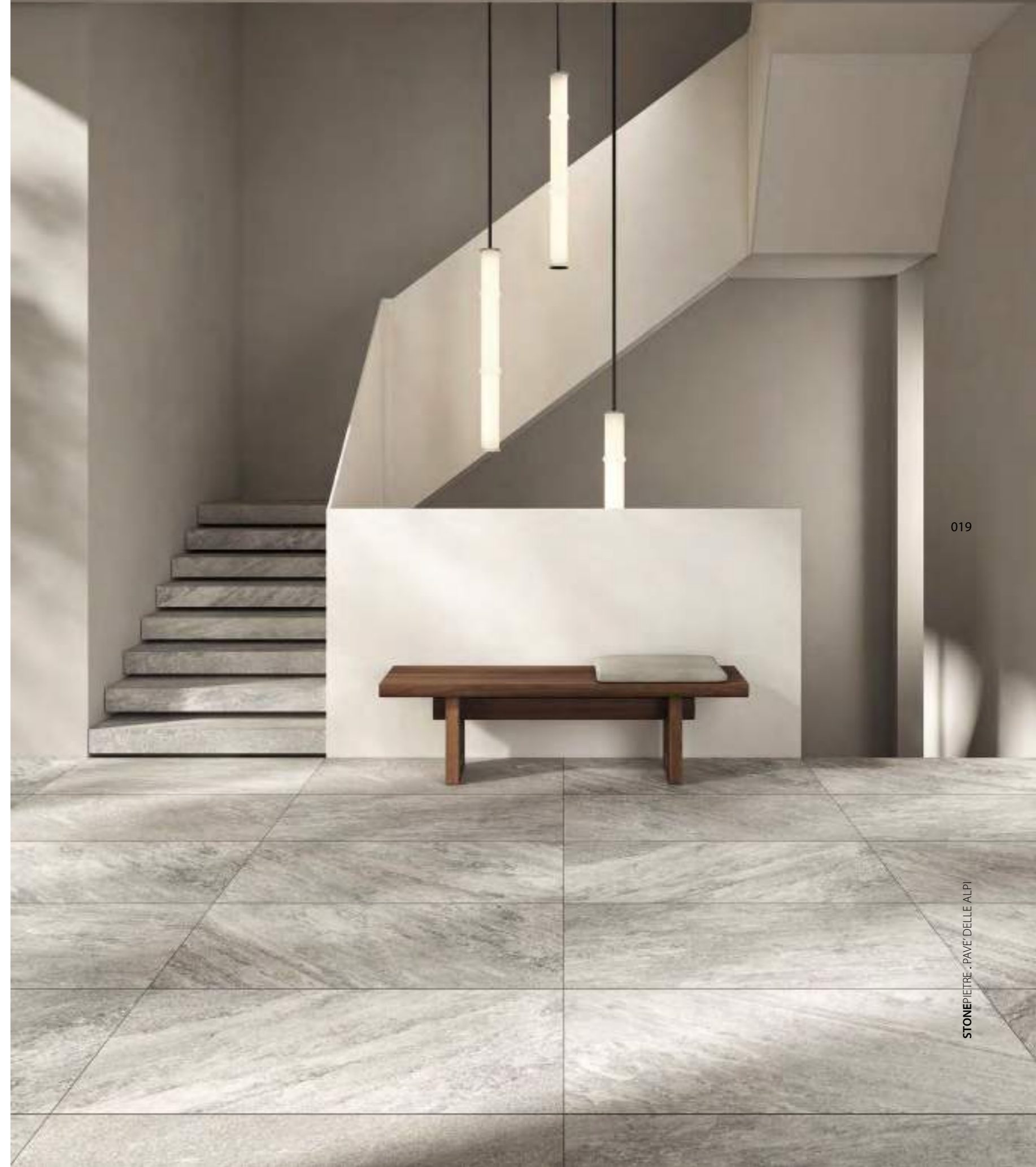

LIVING YOUR SPACE

020

021



022



023





024

STONEPIETRE - PAVI D'ELLE ALPI



025



026



027



030



← INDEX



031

STONEPIETRE - MYSTONE

COOKING MEETS LIFE



032



033



034



035



036

STONEPIETRE · CHANTILLY



037



038



039

MARBLEMARM - PRESTIGE



040

STONEPIETRE . CREMA LUNA



041



042



← INDEX

043

STONEPIETRE · ARDENNES

DAY&NIGHT IN HARMONY

044

045



046



047



048



049

STONEPIETRE - CREMA LUNA



050

MARBLEMARMO - PRESTIGE



051

RELAX YOUR DAILY RITUAL

052

053

WOODLEGNI - PARKETT





054

CONTEMPORARY CONTEMPORANEO_94_EV01_PROGETTO57



055







060

061

062



063



STONEPIETRE · CREMA LUNA

WORK WITH STYLE

064

065





068

STONEPIETRE - PAVE' DELLE ALPI



069



072

073



OUTDOOR FRESH MOMENTS

074

075

STONEPIETRE . AMBOISE



078



079

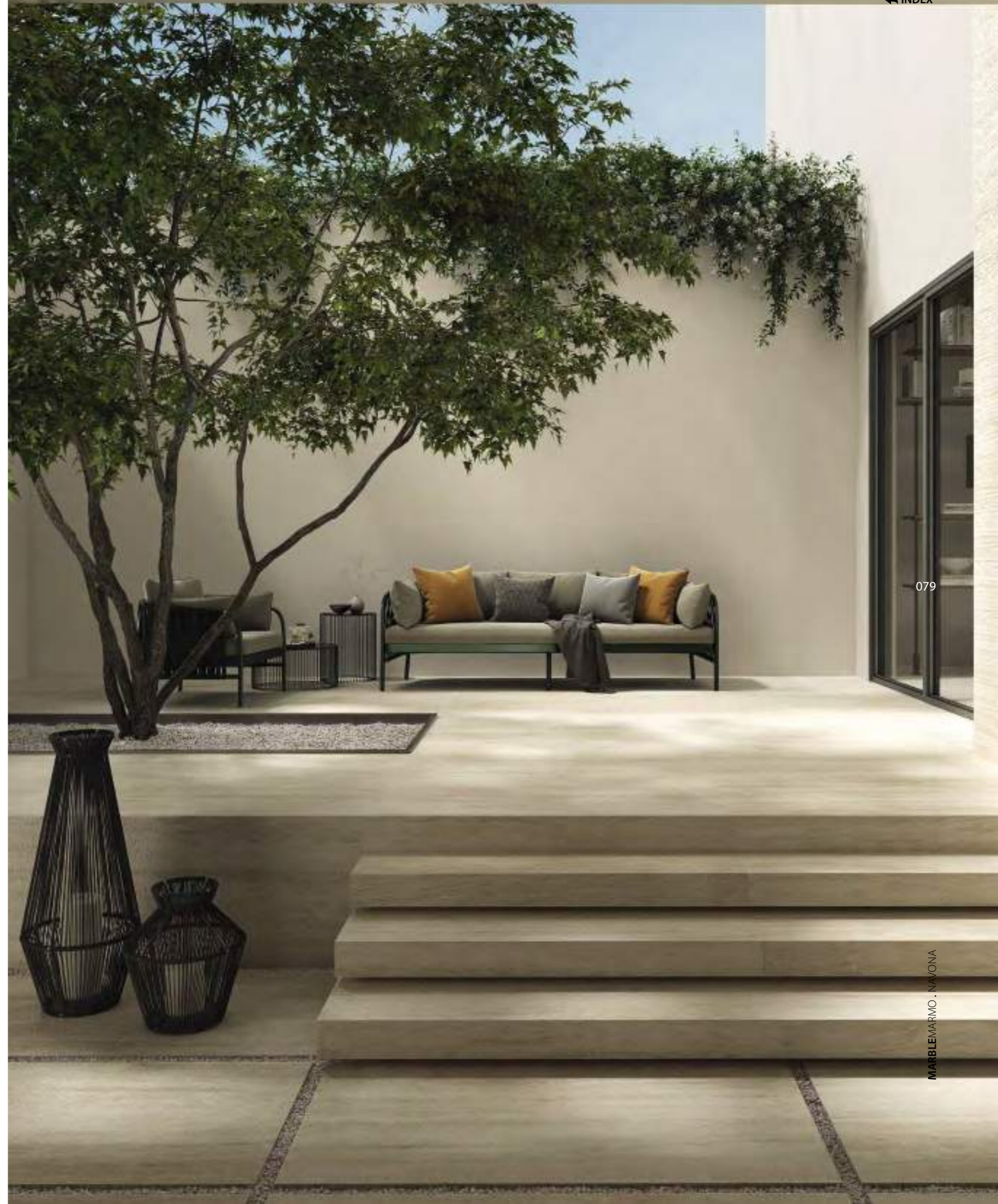



080

081



STONEPIETRE

083

ARDENNES	084
MYSTONE	092
CHANTILLY	098
CREMA LUNA	104
PAVÉ DELLE ALPI	112
AMBOISE	126
PAVÉ WALL 30.90	136
AR_GENT	140
CHATEAUX	146
PAVÉ WALL DOLMEN	152
PAVÉ WALL HOUSE	156

084



PEARL CREAM NUT GREY

ARDENNES

Ardennes reinventa l'ardesia in chiave moderna, unendo essenzialità e creatività. Texture materiche e superfici raffinate creano un progetto versatile e decorativo.

Ardennes reinterprets slate with a modern touch, blending simplicity and creativity. Rich textures and refined surfaces make it a versatile and decorative solution.

Ardennes réinvente l'ardoise dans un style contemporain, alliant simplicité et créativité. Ses textures riches et ses surfaces raffinées offrent un projet polyvalent et décoratif.

Ardennes interpretiert Schiefer modern neu und vereint dabei Schlichtheit mit Kreativität. Die strukturierten, feinen Oberflächen machen das Projekt vielseitig und dekorativ.



085

ARDENNES



PEARL



199951 - 90x90 . 36"x36" Ret -MATT PM - 50,00



199911 - 60x120 . 24"x48" Ret - MATT PM - 50,00



151051 - 60x120 . 24"x48" Ret - CHALKS Pearl PM - 78,00



199931 - 60x60 . 24"x24" Ret - MATT PM - 39,90



199971 - 60x120 . 24"x48" Ret - PATCHWORK Multicolor PM - 75,00

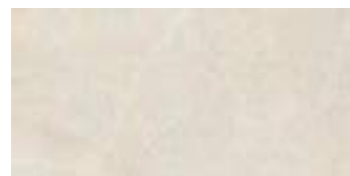

151421 - 30x60 . 12"x24" Ret - MATT PM - 39,90

086

CREAM



199952 - 90x90 . 36"x36" Ret -MATT PM - 50,00

151802 - 90x90 . 36"x36" Ret -GRIP PM - 50,00

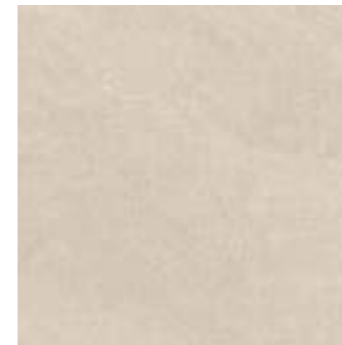

199932 - 60x60 . 24"x24" Ret - MATT PM - 39,90

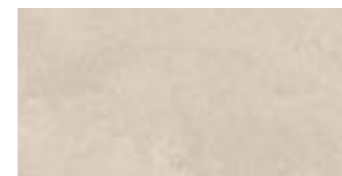

151422 - 30x60 . 12"x24" Ret - MATT PM - 39,90



199912 - 60x120 . 24"x48" Ret - MATT PM - 50,00



151052 - 60x120 . 24"x48" Ret - CHALKS Cream PM - 78,00



199971 - 60x120 . 24"x48" Ret - PATCHWORK Multicolor PM - 75,00



151031 - 60x120 . 24"x48" Ret - OPART Cream&Nut PM - 75,00

087

ARDENNES



NUT



199953 - 90x90 . 36"x36" Ret -MATT **PM - 50,00**
151803 - 90x90 . 36"x36" Ret -GRIP **PM - 50,00**



199933 - 60x60 . 24"x24" Ret - MATT **PM - 39,90**

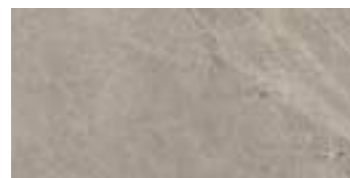

151423 - 30x60 . 12"x24" Ret - MATT **PM - 39,90**



199913 - 60x120 . 24"x48" Ret - MATT **PM - 50,00**



151053 - 60x120 . 24"x48" Ret - CHALKS Nut **PM - 78,00**



199971 - 60x120 . 24"x48" Ret - PATCHWORK Multicolor **PM - 75,00**



151031 - 60x120 . 24"x48" Ret - OPART Cream&Nut **PM - 75,00**

GREY

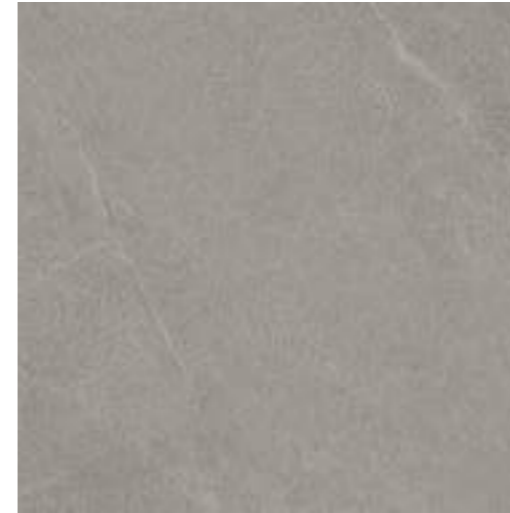

199954 - 90x90 . 36"x36" Ret -MATT **PM - 50,00**



199934 - 60x60 . 24"x24" Ret - MATT **PM - 39,90**



151424 - 30x60 . 12"x24" Ret - MATT **PM - 39,90**



199914 - 60x120 . 24"x48" Ret - MATT **PM - 50,00**



151054 - 60x120 . 24"x48" Ret - CHALKS Grey **PM - 78,00**



199971 - 60x120 . 24"x48" Ret - PATCHWORK Multicolor **PM - 75,00**

088

089

V2	FACCE DIFFERENTI Different Patterns
90x90	8
60x120	8
60x120 Chalks, Patchwork, Opart	1
60x60	16
30x60	32

PEZZI SPECIALI 9MM . SPECIAL PIECES . PIÈCES SPÉCIALES . SPEZIALTEILE



PL - 13,50
Battiscopa
 6x60 . 2"x24" Ret - MATT
151451 - Pearl
151452 - Cream
151453 - Nut
151454 - Grey



PP - 250,00
Gradino Costa Retta
 33x120 . 13"x48" Ret - MATT
151481 - Pearl
151482 - Cream
151483 - Nut
151484 - Grey



PP - 300,00
Angolo Gradino Costa Retta DX
 33x120 . 13"x48" Ret - MATT
151491 - Pearl
151492 - Cream
151493 - Nut
151494 - Grey



PP - 300,00
Angolo Gradino Costa Retta SX
 33x120 . 13"x48" Ret - MATT
151501 - Pearl
151502 - Cream
151503 - Nut
151504 - Grey

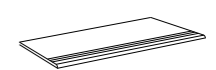

PL - 68,00
Gradino Becco di Civetta con Righe
 30x60 . 12"x24" Ret - MATT
151511 - Pearl
151512 - Cream
151513 - Nut
151514 - Grey

ARDENNES 20MM



PEARL

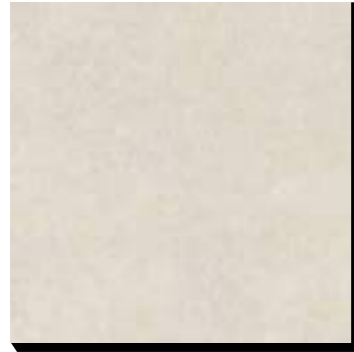

151091 - 60x120 . 24"x48"
Ret - GRIP PM - 77,50

CREAM

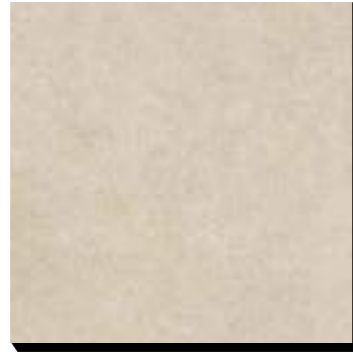

151092 - 60x120 . 24"x48"
Ret - GRIP PM - 77,50

151532 - 60x60 . 24"x24"
Ret - GRIP PM - 66,00

NUT



151093 - 60x120 . 24"x48"
Ret - GRIP PM - 77,50

151533 - 60x60 . 24"x24"
Ret - GRIP PM - 66,00

GREY

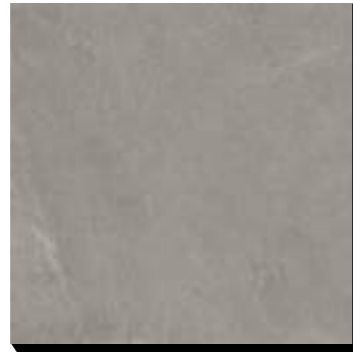

151094 - 60x120 . 24"x48"
Ret - GRIP PM - 77,50

090

091



PEZZI SPECIALI 20MM. SPECIAL PIECES . PIÈCES SPÉCIALES . SPEZIALTEILE

infotech p. 280

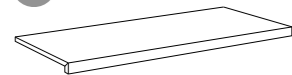

PP - 302,00

Gradino Costa Retta
33x120 . 13"x48" Ret - GRIP

- 151541** - Pearl
- 151542** - Cream
- 151543** - Nut
- 151544** - Grey

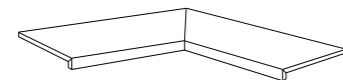

PP - 757,00

Angolo Int. Gradino Costa Retta
33x120 . 13"x48" Ret - GRIP

- 151561** - Pearl
- 151562** - Cream
- 151563** - Nut
- 151564** - Grey

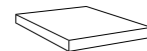

PP - 168,00

Angolo Est. Gradino Costa Retta
33x33 . 13"x13" Ret - GRIP

- 151571** - Pearl
- 151572** - Cream
- 151573** - Nut
- 151574** - Grey

092



WHITE



SAND



SILVER



BLACK

MYSTONE

Una collezione dal carattere deciso che unisce marmo e pietra, dove venature naturali e superfici traslucide conferiscono un'eleganza senza pari.

A collection with a strong character, blending marble and stone, where natural veining and translucent surfaces create unparalleled elegance.

Une collection au caractère affirmé qui marie marbre et pierre, où les veines naturelles et les surfaces translucides offrent une élégance unique.

Eine Kollektion mit markantem Charakter, die Marmor und Stein vereint, wobei natürliche Maserungen und transluzente Oberflächen unvergleichliche Eleganz ausstrahlen.



093

MYSTONE



WHITE



151391 - 90x90 . 36"x36"
Ret - MATT PM - 50,00

SAND



151392 - 90x90 . 36"x36"
Ret - MATT PM - 50,00

SILVER



151393 - 90x90 . 36"x36"
Ret - MATT PM - 50,00

BALCK

094



151151 - 60x120 . 24"x48"
Ret - MATT PM - 50,00



151152 - 60x120 . 24"x48"
Ret - MATT PM - 50,00



151153 - 60x120 . 24"x48"
Ret - MATT PM - 50,00



151154 - 60x120 . 24"x48"
Ret - MATT PM - 50,00

095



151171 - 60x60 . 24"x24"
Ret - MATT PM - 39,90



151172 - 60x60 . 24"x24"
Ret - MATT PM - 39,90



151173 - 60x60 . 24"x24"
Ret - MATT PM - 39,90



151174 - 60x60 . 24"x24"
Ret - MATT PM - 39,90

PEZZI SPECIALI 9MM . SPECIAL PIECES . PIÈCES SPÉCIALES . SPEZIALTEILE



FACCE DIFFERENTI
Different Patterns

90x90	9
60x120	9
60x60	18

infotech p. 280



Battiscopa
6x60 . 2"x24" Ret - MATT

151471 - White
151472 - Sand

151473 - Silver
151474 - Black

MYSTONE 20MM



SAND



151412 - 60x120 . 24"x48" Ret - GRIP

PM - 77,50



151462 - 60x60 . 24"x24" Ret - GRIP

PM - 66,00

SILVER



151413 - 60x120 . 24"x48" Ret - GRIP

PM - 77,50



151463 - 60x60 . 24"x24" Ret - GRIP

PM - 66,00

096

097



V2

FACCE DIFFERENTI
Different Patterns

60x120	9
60x60	18

098



BLANC CRÈME BEIGE MÉLANGE MÉLANGE DE NUIT

CHANTILLY

Ispirata ai castelli medievali, con superficie strutturata e bordo anticato "chipped edge", Chantilly unisce eleganza senza tempo e performance tecniche eccellenti.

Inspired by medieval castles, Chantilly blends timeless elegance with durable, high-performance surfaces featuring a subtly textured, antiqued edge.

Inspirée par les châteaux médiévaux, Chantilly allie élégance intemporelle et résistance technique, avec une surface texturée et un bord vieilli raffiné.

Von mittelalterlichen Burgen inspiriert, vereint Chantilly zeitlose Eleganz mit robuster Technik und einer dezent strukturierten, antik wirkenden Kante.



099

CHANTILLY

BLANC



197721 - 60x90 . 24"x36"
Chipped Ret - NATURALE PM - 46,80



197741 - 60x60 . 24"x24"
Chipped Ret - NATURALE PM - 40,50



197761 - 30x60 . 12"x24"
Chipped Ret - NATURALE PM - 40,50



197891 - 30x30 . 12"x12"
Chipped Ret - NATURALE PM - 40,50



BEIGE



197723 - 60x90 . 24"x36"
Chipped Ret - NATURALE PM - 46,80

197873 - 60x90 . 24"x36"
Chipped Ret - GRIP PM - 46,80



197743 - 60x60 . 24"x24"
Chipped Ret - NATURALE PM - 40,50



197763 - 30x60 . 12"x24"
Chipped Ret - NATURALE PM - 40,50



197893 - 30x30 . 12"x12"
Chipped Ret - NATURALE PM - 40,50

CRÈME



197722 - 60x90 . 24"x36"
Chipped Ret - NATURALE PM - 46,80

197872 - 60x90 . 24"x36"
Chipped Ret - GRIP PM - 46,80



197742 - 60x60 . 24"x24"
Chipped Ret - NATURALE PM - 40,50



197762 - 30x60 . 12"x24"
Chipped Ret - NATURALE PM - 40,50

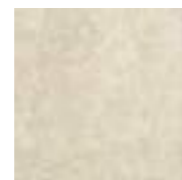

197892 - 30x30 . 12"x12"
Chipped Ret - NATURALE PM - 40,50

CHANTILLY 20MM

GRES PORCELLANATO . PORCELAIN STONEWARE . GRÈS CÉRAME . FEINSTEINZEUG



CRÈME



197782 - 60x90 . 24"x36"
Chipped Ret - GRIP PM - 76,50

BEIGE



197783 - 60x90 . 24"x36"
Chipped Ret - GRIP PM - 76,50



SVILUPPO GRAFICO / PATTERNS

60x90 **28** Facce differenti / Different Patterns
60x60 **28** Facce differenti / Different Patterns
30x60 **56** Facce differenti / Different Patterns
30x30 **112** Facce differenti / Different Patterns

ATTENZIONE . BE CAREFUL . ATTENTION . ACHTUNG

Nella posa modulare è obbligatoria la fuga di 2 mm.
When laying different sizes tiles envisaged for modular laying, a gap of 2 mm is required.
La pose modulaire exige obligatoirement un joint de 2 mm.
Bei Modul- Verlegung sind 2 mm Fuge empfehlenswert.

CHANTILLY



MÉLANGE



- 197724** - 60x90 . 24"x36" Chipped Ret - NATURALE PM - 46,80
- 199044** - 60x90 . 24"x36" Chipped Ret - SOFT GRIP PM - 46,80
- 197874** - 60x90 . 24"x36" Chipped Ret - GRIP PM - 46,80



- 197764** - 30x60 . 12"x24" Chipped Ret - NATURALE PM - 40,50
- 198834** - 30x60 . 12"x24" Chipped Ret - SOFT GRIP PM - 40,50



- 197744** - 60x60 . 24"x24" Chipped Ret - NATURALE PM - 40,50
- 198814** - 60x60 . 24"x24" Chipped Ret - SOFT GRIP PM - 40,50



- 197894** - 30x30 . 12"x12" Chipped Ret - NATURALE PM - 40,50



"PRODOTTO CON MARCATA STONALIZZAZIONE CROMATICA"
 "PRODUCT WITH SIGNIFICANT SHADE VARIATION"
 "PRODUIT AVEC NUANCE DE COULEUR MARQUÉE"
 "PRODUKT MIT AUSGEPRÄGTER FARBSCHATTIERUNG"

MÉLANGE DE NUIT

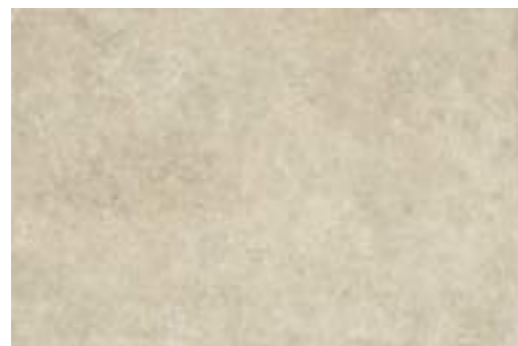

- 197725** - 60x90 . 24"x36" Chipped Ret - NATURALE PM - 46,80
- 199045** - 60x90 . 24"x36" Chipped Ret - SOFT GRIP PM - 46,80
- 197875** - 60x90 . 24"x36" Chipped Ret - GRIP PM - 46,80



- 197765** - 30x60 . 12"x24" Chipped Ret - NATURALE PM - 40,50
- 198835** - 30x60 . 12"x24" Chipped Ret - SOFT GRIP PM - 40,50



- 197745** - 60x60 . 24"x24" Chipped Ret - NATURALE PM - 40,50
- 198815** - 60x60 . 24"x24" Chipped Ret - SOFT GRIP PM - 40,50

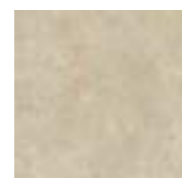

- 197895** - 30x30 . 12"x12" Chipped Ret - NATURALE PM - 40,50



"PRODOTTO CON MARCATA STONALIZZAZIONE CROMATICA"
 "PRODUCT WITH SIGNIFICANT SHADE VARIATION"
 "PRODUIT AVEC NUANCE DE COULEUR MARQUÉE"
 "PRODUKT MIT AUSGEPRÄGTER FARBSCHATTIERUNG"

CHANTILLY 20MM



MÉLANGE



- 197784** - 60x90 . 24"x36" Chipped Ret - GRIP PM - 76,50

MÉLANGE DE NUIT

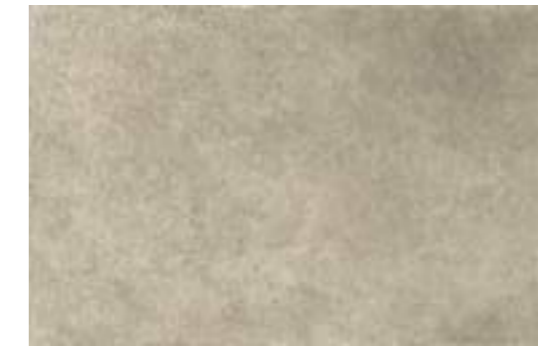

- 197785** - 60x90 . 24"x36" Chipped Ret - GRIP PM - 76,50



SVILUPPO GRAFICO / PATTERNS

- 60x90 **28** Facce differenti / Different Patterns
- 60x60 **28** Facce differenti / Different Patterns
- 30x60 **56** Facce differenti / Different Patterns
- 30x30 **112** Facce differenti / Different Patterns

"PRODOTTO CON MARCATA STONALIZZAZIONE CROMATICA"
 "PRODUCT WITH SIGNIFICANT SHADE VARIATION"
 "PRODUIT AVEC NUANCE DE COULEUR MARQUÉE"
 "PRODUKT MIT AUSGEPRÄGTER FARBSCHATTIERUNG"

- Per una resa estetica migliore, è consigliabile aprire diverse scatole contemporaneamente e mescolare piastrelle provenienti da scatole diverse.

- For a better aesthetic installation, it is advisable to open several boxes at the same time and mix tiles from different boxes.

- Pour un meilleur rendement esthétique, il est conseillé d'ouvrir plusieurs cartons en même temps et de mélanger les carreaux de différents cartons.

- Um ein besseres ästhetisches Ergebnis zu erzielen, empfehlen wir Ihnen, mehrere Kartons gleichzeitig zu öffnen und Fliesen aus verschiedenen Kartons zu mischen.

PEZZI SPECIALI 9MM . SPECIAL PIECES . PIÈCES SPÉCIALES . SPEZIALTEILE



PL - 13,50

- Battiscopa**
 6x60 . 2"x24" Chipped Ret - NATURALE
- 197911** - Blanc
 - 197912** - Crème
 - 197913** - Beige
 - 197914** - Mélange
 - 197915** - Mélange de Nuit



PP - 145,00

- Gradino Costa Retta**
 33x60 . 13"x24" Chipped Ret - NATURALE
- 197921** - Blanc
 - 197922** - Crème
 - 197923** - Beige
 - 197924** - Mélange
 - 197925** - Mélange de Nuit

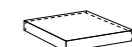

PP - 156,00

- Angolo Gradino Costa Retta**
 33x33 . 13"x13" Chipped Ret - NATURALE
- 197931** - Blanc
 - 197932** - Crème
 - 197933** - Beige
 - 197934** - Mélange
 - 197935** - Mélange de Nuit



PP - 145,00

- Gradino Costa Retta**
 33x60 . 13"x24" Chipped Ret - SOFT GRIP
- 199054** - Mélange
 - 199055** - Mélange de Nuit

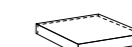

PP - 156,00

- Angolo Gradino Costa Retta**
 33x33 . 13"x13" Chipped Ret - SOFT GRIP
- 199064** - Mélange
 - 199065** - Mélange de Nuit

PEZZI SPECIALI 20MM . SPECIAL PIECES . PIÈCES SPÉCIALES . SPEZIALTEILE

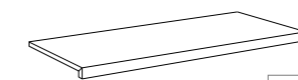

PP - 265,00

- Gradino Costa Retta**
 33x90 . 13"x36" Chipped Ret - GRIP
- 197942** - Crème
 - 197943** - Beige
 - 197944** - Mélange
 - 197945** - Mélange de Nuit

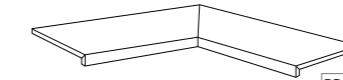

PP - 620,00

- Angolo Int. Gradino Costa Retta**
 33x90 . 13"x36" Chipped Ret - GRIP
- 197952** - Crème
 - 197953** - Beige
 - 197954** - Mélange
 - 197955** - Mélange de Nuit

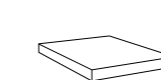

PP - 140,00

- Angolo Est. Gradino Costa Retta**
 33x33 . 13"x13" Chipped Ret - GRIP
- 197962** - Crème
 - 197963** - Beige
 - 197964** - Mélange
 - 197965** - Mélange de Nuit

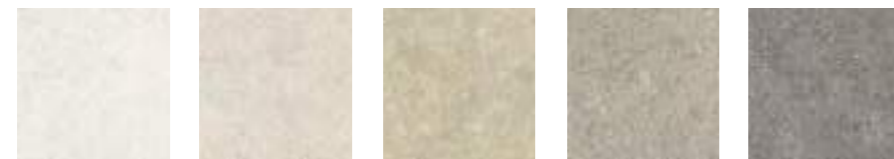

PEARL CREAM BEIGE MIST URBAN

CREMA LUNA

Crema Luna evoca la morbidezza della pietra naturale Limestone, con tonalità calde e delicate venature, per ambienti accoglienti e senza tempo.

Crema Luna captures the soft elegance of natural limestone, with warm tones and subtle veining, creating welcoming and timeless spaces.

Crema Luna reflète la douceur et l'élégance du limestone naturel, avec des teintes chaleureuses et des veinures délicates, pour des espaces accueillants et intemporels.

Crema Luna vermittelt die sanfte Eleganz natürlichen Limestones, mit warmen Farbtönen und feinen Maserungen, und schafft einladende, zeitlose Räume.



CREMA LUNA



PEARL



198151 - 90x90 . 36"x36"
Ret - MATT PM - 50,00



198051 - 60x120 . 24"x48"
Ret - MATT PM - 50,00

198071 - 60x120 . 24"x48"
Ret - Bocciardato SOFT GRIP PM - 51,50

CREAM



198152 - 90x90 . 36"x36"
Ret - MATT PM - 50,00



198052 - 60x120 . 24"x48"
Ret - MATT PM - 50,00

198072 - 60x120 . 24"x48"
Ret - Bocciardato SOFT GRIP PM - 51,50

106

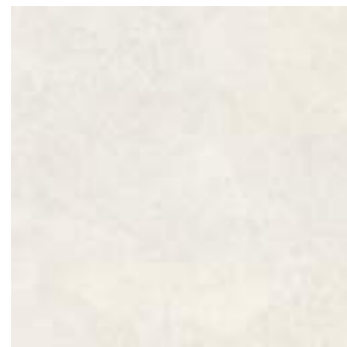

198091 - 60x60 . 24"x24"
Ret - MATT PM - 39,90



198111 - 60x120 . 24"x48"
Ret - Bambus MATT PM - 63,00

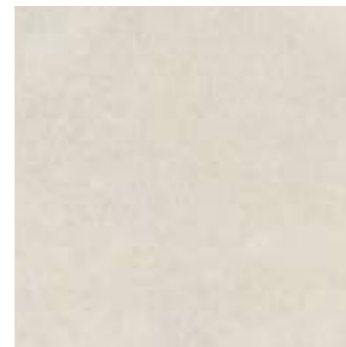

198092 - 60x60 . 24"x24"
Ret - MATT PM - 39,90



198112 - 60x120 . 24"x48"
Ret - Bambus MATT PM - 63,00

107



198731 - 30x60 . 12"x24"
Ret - MATT PM - 39,90

198551 - 30x60 . 12"x24"
Ret - Bocciardato SOFT GRIP PM - 39,90



198131 - 20x60 . 8"x24"
Tuscia Pearl - Muretto **10mm** PM - 57,00

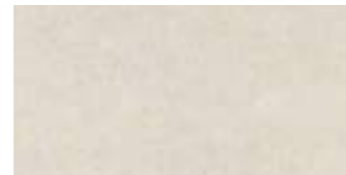

198732 - 30x60 . 12"x24"
Ret - MATT PM - 39,90

198552 - 30x60 . 12"x24"
Ret - Bocciardato SOFT GRIP PM - 39,90



198132 - 20x60 . 8"x24"
Tuscia Cream - Muretto **10mm** PM - 57,00



198136 - 20x60 . 8"x24"
Tuscia Blend - Muretto **10mm** PM - 57,00



CREMA LUNA

BEIGE



198153 - 90x90 . 36"x36"
Ret - MATT PM - 50,00



198053 - 60x120 . 24"x48"
Ret - MATT PM - 50,00

198073 - 60x120 . 24"x48"
Ret - Bocciardato SOFT GRIP PM - 51,50

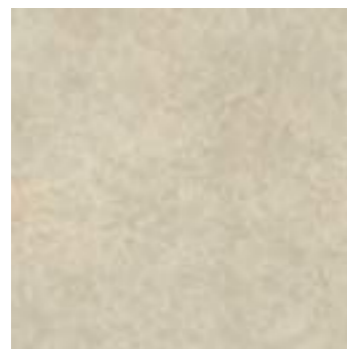

198093 - 60x60 . 24"x24"
Ret - MATT PM - 39,90



198113 - 60x120 . 24"x48"
Ret - Bambus MATT PM - 63,00



198733 - 30x60 . 12"x24"
Ret - MATT PM - 39,90

198553 - 30x60 . 12"x24"
Ret - Bocciardato SOFT GRIP PM - 39,90



198136 - 20x60 . 8"x24"
Tuscia Blend - Muretto **10mm** PM - 57,00



STUCCO FACILE



MIST



198154 - 90x90 . 36"x36"
Ret - MATT PM - 50,00



198054 - 60x120 . 24"x48"
Ret - MATT PM - 50,00

198074 - 60x120 . 24"x48"
Ret - Bocciardato SOFT GRIP PM - 51,50

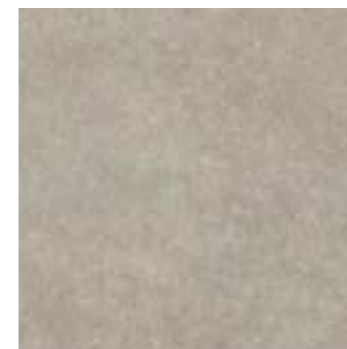

198094 - 60x60 . 24"x24"
Ret - MATT PM - 39,90



198114 - 60x120 . 24"x48"
Ret - Bambus MATT PM - 63,00



198734 - 30x60 . 12"x24"
Ret - MATT PM - 39,90

198554 - 30x60 . 12"x24"
Ret - Bocciardato SOFT GRIP PM - 39,90



198134 - 20x60 . 8"x24"
Tuscia Mist - Muretto **10mm** PM - 57,00



STUCCO FACILE



198136 - 20x60 . 8"x24"
Tuscia Blend - Muretto **10mm** PM - 57,00



STUCCO FACILE

CREMA LUNA



URBAN



198155 - 90x90 . 36"x36"
Ret - MATT PM - 50,00



198055 - 60x120 . 24"x48"
Ret - MATT PM - 50,00

198075 - 60x120 . 24"x48"
Ret - Bocciardato SOFT GRIP PM - 51,50



198095 - 60x60 . 24"x24"
Ret - MATT PM - 39,90



198115 - 60x120 . 24"x48"
Ret - Bambus MATT PM - 63,00

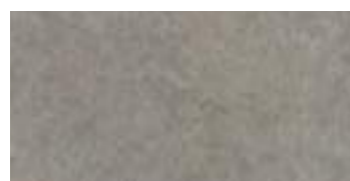

198735 - 30x60 . 12"x24"
Ret - MATT PM - 39,90

198555 - 30x60 . 12"x24"
Ret - Bocciardato SOFT GRIP PM - 39,90



198136 - 20x60 . 8"x24"
Tuscia Blend - Muretto 10mm PM - 57,00



PEZZI SPECIALI 9MM . SPECIAL PIECES . PIÈCES SPÉCIALES . SPEZIALTEILE



PL - 13,50

Battiscopa
6x60 . 2"x24" Ret - MATT
198201 - Pearl
198202 - Cream
198203 - Beige
198204 - Mist
198205 - Urban

PP - 250,00

Gradino Costa Retta
33x120 . 13"x48" Ret - MATT
198231 - Pearl
198232 - Cream
198233 - Beige
198234 - Mist
198235 - Urban

PP - 300,00

Angolo Gradino Costa Retta DX
33x120 . 13"x48" Ret - MATT
198241 - Pearl
198242 - Cream
198243 - Beige
198244 - Mist
198245 - Urban

PP - 300,00

Angolo Gradino Costa Retta SX
33x120 . 13"x48" Ret - MATT
198251 - Pearl
198252 - Cream
198253 - Beige
198254 - Mist
198255 - Urban

PL - 68,00

Gradino Becco di Civetta con Righe
30x60 . 12"x24" Ret - MATT
198211 - Pearl
198212 - Cream
198213 - Beige
198214 - Mist
198215 - Urban

CREMA LUNA 20MM



CREAM

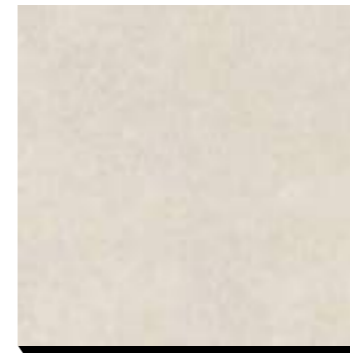

198172 - 90x90 . 36"x36"
Ret - Bocciardato GRIP PM - 77,50

198272 - 60x120 . 24"x48"
Ret - Bocciardato GRIP PM - 77,50

198702 - 60x60 . 24"x24"
Ret - Bocciardato GRIP PM - 66,00

MIST

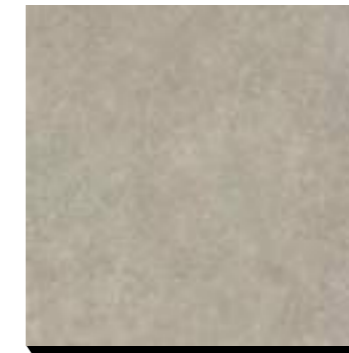

198174 - 90x90 . 36"x36"
Ret - Bocciardato GRIP PM - 77,50

198274 - 60x120 . 24"x48"
Ret - Bocciardato GRIP PM - 77,50

198704 - 60x60 . 24"x24"
Ret - Bocciardato GRIP PM - 66,00

URBAN



198175 - 90x90 . 36"x36"
Ret - Bocciardato GRIP PM - 77,50

198275 - 60x120 . 24"x48"
Ret - Bocciardato GRIP PM - 77,50

198705 - 60x60 . 24"x24"
Ret - Bocciardato GRIP PM - 66,00



SVILUPPO GRAFICO / PATTERNS

60x120	8 Facce differenti / Different Patterns
90x90	8 Facce differenti / Different Patterns
60x60	16 Facce differenti / Different Patterns
30x60	32 Facce differenti / Different Patterns
20x60 Tuscia	18 Facce differenti / Different Patterns
20x60 Tuscia Blend	30 Facce differenti / Different Patterns

PEZZI SPECIALI 20MM . SPECIAL PIECES . PIÈCES SPÉCIALES . SPEZIALTEILE

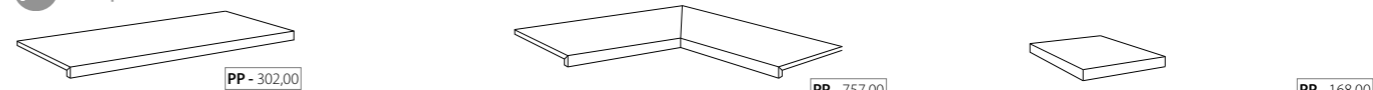

Gradino Costa Retta
33x120 . 13"x48" Ret - Bocciardato GRIP PP - 302,00
198282 - Cream
198284 - Mist
198285 - Urban

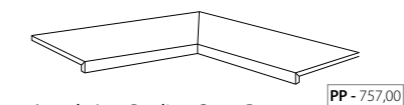

Angolo Int. Gradino Costa Retta
33x120 . 13"x48" Ret - Bocciardato GRIP PP - 757,00
198292 - Cream
198294 - Mist
198295 - Urban



Angolo Est. Gradino Costa Retta
33x33 . 13"x13" Ret - Bocciardato GRIP PP - 168,00
198302 - Cream
198304 - Mist
198305 - Urban



GRANITO PIETRA LUSERNA SESTRIERE QUARZO GRIGIO QUARZO MULTICOLORE PIASENTINA VALMALENCO PORFIDO

PAVÉ DELLE ALPI

Pavé delle Alpi reinterpreta la tradizione delle pavimentazioni in pietra alpina con una versatilità progettuale all'avanguardia: spessori variabili, colori autentici, texture materiche e formati adatti ad ogni contesto residenziale e contract.

Pavé delle Alpi reinterprets the tradition of Alpine stone flooring with cutting-edge design versatility: variable thicknesses, authentic colors, textured surfaces, and formats suited to both residential and contract spaces.

Pavé des Alpes réinterprète la tradition des sols en pierre alpine avec une grande flexibilité de conception : épaisseurs variées, couleurs authentiques, surfaces texturées et formats adaptés aux espaces résidentiels et contractuels.

Pavé delle Alpen interpretiert die Tradition alpiner Steinböden neu und bietet moderne Gestaltungsmöglichkeiten: variable Stärken, authentische Farben, strukturierte Oberflächen und Formate für Wohn- und Contract-Bereiche.



PAVÉ DELLE ALPI

GRANITO



199828 - 60x120 . 24"x48" Ret - SOFT GRIP

PM - 50,00

9 mm



196248 - 60x60 . 24"x24" Ret - SOFT GRIP

PM - 39,90

9 mm



195478 - 22,5x45 . 9"x18" GRIP

PM - 39,90

10 mm



195488 - 22,5x22,5 . 9"x9" GRIP

PM - 39,90

10 mm



195738 - 30x60 . 12"x24" Ret - SOFT GRIP

PM - 39,90

9 mm

19588 - 30x60 . 12"x24" Ret - GRIP

PM - 39,90

9 mm



195498 - 22,5x45 . 9"x18" GRIP

PM - 49,90

14 mm



195518 - 22,5x22,5 . 9"x9" GRIP

PM - 49,90

14 mm



197008 - 10x60 . 4"x24" Muretto

PM - 57,00

10 mm



STUCCO FACILE

V3

SVILUPPO GRAFICO / PATTERNS GRANITO

- 60x120 **8** Facce differenti / Different Patterns
- 60x60 **16** Facce differenti / Different Patterns
- 30x60 **32** Facce differenti / Different Patterns
- 22,5x45 **40** Facce differenti / Different Patterns
- 22,5x22,5 **80** Facce differenti / Different Patterns
- 10x60 Muretto **96** Facce differenti / Different Patterns



PIETRA LUSERNA



19982A - 60x120 . 24"x48" Ret - SOFT GRIP

PM - 50,00

9 mm



19624A - 60x60 . 24"x24" Ret - SOFT GRIP

PM - 39,90

9 mm



19547A - 22,5x45 . 9"x18" GRIP

PM - 39,90

10 mm



19548A - 22,5x22,5 . 9"x9" GRIP

PM - 39,90

10 mm



19573A - 30x60 . 12"x24" Ret - SOFT GRIP

PM - 39,90

9 mm

19588A - 30x60 . 12"x24" Ret - GRIP

PM - 39,90

9 mm



19549A - 22,5x45 . 9"x18" GRIP

PM - 49,90

14 mm



19551A - 22,5x22,5 . 9"x9" GRIP

PM - 49,90

14 mm



19700A - 10x60 . 4"x24" Muretto

PM - 57,00

10 mm



STUCCO FACILE

V3

SVILUPPO GRAFICO / PATTERNS GRANITO

- 60x120 **8** Facce differenti / Different Patterns
- 60x90 **8** Facce differenti / Different Patterns
- 60x60 **16** Facce differenti / Different Patterns
- 30x60 **32** Facce differenti / Different Patterns
- 22,5x45 **40** Facce differenti / Different Patterns
- 22,5x22,5 **80** Facce differenti / Different Patterns
- 10x60 Muretto **96** Facce differenti / Different Patterns

PAVÉ DELLE ALPI

SESTRIERE



199821 - 60x120 . 24"x48" Ret - SOFT GRIP

PM - 50,00

9 mm



196241 - 60x60 . 24"x24" Ret - SOFT GRIP

PM - 39,90

9 mm



195471 - 22,5x45 . 9"x18" GRIP

PM - 39,90

10 mm



195481 - 22,5x22,5 . 9"x9" GRIP

PM - 39,90

10 mm

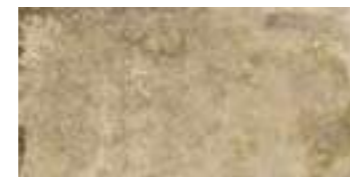

195731 - 30x60 . 12"x24" Ret - SOFT GRIP

PM - 39,90

9 mm

195581 - 30x60 . 12"x24" Ret - GRIP

PM - 39,90

9 mm



195491 - 22,5x45 . 9"x18" GRIP

PM - 49,90

14 mm



195511 - 22,5x22,5 . 9"x9" GRIP

PM - 49,90

14 mm



197001 - 10x60 . 4"x24" Muretto

PM - 57,00

10 mm



STUCCO FACILE

V4

SVILUPPO GRAFICO / PATTERNS SESTRIERE

- 60x120 **14** Facce differenti / Different Patterns
- 60x90 2cm **28** Facce differenti / Different Patterns
- 60x60 **42** Facce differenti / Different Patterns
- 30x60 **84** Facce differenti / Different Patterns
- 22,5x45 **112** Facce differenti / Different Patterns
- 22,5x22,5 **224** Facce differenti / Different Patterns
- 10x60 Muretto **48** Facce differenti / Different Patterns



QUARZO GRIGIO



199822 - 60x120 . 24"x48" Ret - SOFT GRIP

PM - 50,00

9 mm



196242 - 60x60 . 24"x24" Ret - SOFT GRIP

PM - 39,90

9 mm



195472 - 22,5x45 . 9"x18" GRIP

PM - 39,90

10 mm



195482 - 22,5x22,5 . 9"x9" GRIP

PM - 39,90

10 mm



195732 - 30x60 . 12"x24" Ret - SOFT GRIP

PM - 39,90

9 mm

195582 - 30x60 . 12"x24" Ret - GRIP

PM - 39,90

9 mm



195492 - 22,5x45 . 9"x18" GRIP

PM - 49,90

14 mm



195512 - 22,5x22,5 . 9"x9" GRIP

PM - 49,90

14 mm



197002 - 10x60 . 4"x24" Muretto

PM - 57,00

10 mm



STUCCO FACILE

V4

SVILUPPO GRAFICO / PATTERNS QUARZO GRIGIO

- 60x120 **12** Facce differenti / Different Patterns
- 60x90 2cm **12** Facce differenti / Different Patterns
- 60x60 **14** Facce differenti / Different Patterns
- 30x60 **28** Facce differenti / Different Patterns
- 22,5x45 **48** Facce differenti / Different Patterns
- 22,5x22,5 **96** Facce differenti / Different Patterns
- 10x60 Muretto **48** Facce differenti / Different Patterns

PAVÉ DELLE ALPI

QUARZO MULTICOLORE



196243 - 60x60 . 24"x24" Ret - SOFT GRIP
PM - 39,90 





195473 - 22,5x45 . 9"x18" GRIP
PM - 39,90 



195483 - 22,5x22,5 . 9"x9" GRIP
PM - 39,90 



195733 - 30x60 . 12"x24" Ret - SOFT GRIP
PM - 39,90 

195583 - 30x60 . 12"x24" Ret - GRIP
PM - 39,90 



195493 - 22,5x45 . 9"x18" GRIP
PM - 49,90 



195513 - 22,5x22,5 . 9"x9" GRIP
PM - 49,90 



197003 - 10x60 . 4"x24" Muretto
PM - 57,00 



STUCCO FACILE

V4  **SVILUPPO GRAFICO / PATTERNS QUARZO MULTICOLORE**
60x90 2cm **30** Facce differenti / Different Patterns
60x60 **30** Facce differenti / Different Patterns
30x60 **60** Facce differenti / Different Patterns
22,5x45 **60** Facce differenti / Different Patterns
22,5x22,5 **120** Facce differenti / Different Patterns
10x60 Muretto **48** Facce differenti / Different Patterns



PIASENTINA



199824 - 60x120 . 24"x48" Ret - SOFT GRIP
PM - 50,00 



196244 - 60x60 . 24"x24" Ret - SOFT GRIP
PM - 39,90 





195474 - 22,5x45 . 9"x18" GRIP
PM - 39,90 





195484 - 22,5x22,5 . 9"x9" GRIP
PM - 39,90 

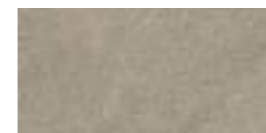

195734 - 30x60 . 12"x24" Ret - SOFT GRIP
PM - 39,90 

195584 - 30x60 . 12"x24" Ret - GRIP
PM - 39,90 



195494 - 22,5x45 . 9"x18" GRIP
PM - 49,90 



195514 - 22,5x22,5 . 9"x9" GRIP
PM - 49,90 



197004 - 10x60 . 4"x24" Muretto
PM - 57,00 



STUCCO FACILE

V3  **SVILUPPO GRAFICO / PATTERNS PIASENTINA**
60x120 **14** Facce differenti / Different Patterns
60x60 **25** Facce differenti / Different Patterns
30x60 **50** Facce differenti / Different Patterns
22,5x45 **60** Facce differenti / Different Patterns
22,5x22,5 **120** Facce differenti / Different Patterns
10x60 Muretto **48** Facce differenti / Different Patterns

PAVÉ DELLE ALPI

VALMALENCO

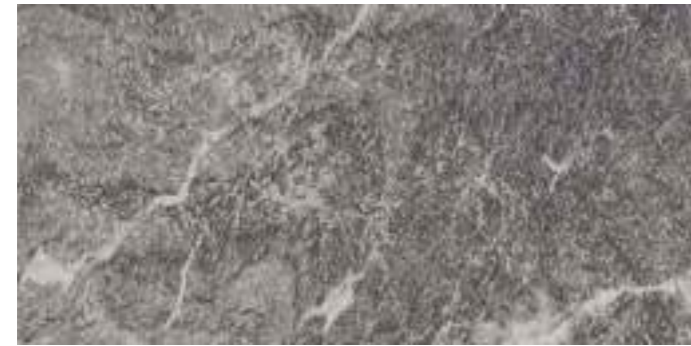

199826 - 60x120 . 24"x48" Ret - SOFT GRIP

PM - 50,00

9 mm



196246 - 60x60 . 24"x24" Ret - SOFT GRIP

PM - 39,90

9 mm



195476 - 22,5x45 . 9"x18" GRIP

PM - 39,90

10 mm



195486 - 22,5x22,5 . 9"x9" GRIP

PM - 39,90

10 mm



195736 - 30x60 . 12"x24" Ret - SOFT GRIP

PM - 39,90

9 mm

195586 - 30x60 . 12"x24" Ret - GRIP

PM - 39,90

9 mm



195496 - 22,5x45 . 9"x18" GRIP

PM - 49,90

14 mm



195516 - 22,5x22,5 . 9"x9" GRIP

PM - 49,90

14 mm



197006 - 10x60 . 4"x24" Muretto

PM - 57,00

10 mm



STUCCO FACILE

V3	SVILUPPO GRAFICO / PATTERNS VALMALENCO	
	60x120	10 Facce differenti / Different Pattern
	60x90 2cm	10 Facce differenti / Different Patterns
	60x60	10 Facce differenti / Different Patterns
	30x60	20 Facce differenti / Different Patterns
	22,5x45	30 Facce differenti / Different Patterns
22,5x22,5	60 Facce differenti / Different Patterns	
10x60 Muretto	48 Facce differenti / Different Patterns	



PORFIDO



199825 - 60x120 . 24"x48" Ret - SOFT GRIP

PM - 50,00

9 mm



196245 - 60x60 . 24"x24" Ret - SOFT GRIP

PM - 39,90

9 mm



195475 - 22,5x45 . 9"x18" GRIP

PM - 39,90

10 mm



195485 - 22,5x22,5 . 9"x9" GRIP

PM - 39,90

10 mm



195735 - 30x60 . 12"x24" Ret - SOFT GRIP

PM - 39,90

9 mm

195585 - 30x60 . 12"x24" Ret - GRIP

PM - 39,90

9 mm



195495 - 22,5x45 . 9"x18" GRIP

PM - 49,90

14 mm



195515 - 22,5x22,5 . 9"x9" GRIP

PM - 49,90

14 mm



197005 - 10x60 . 4"x24" Muretto

PM - 57,00

10 mm



STUCCO FACILE

V4	SVILUPPO GRAFICO / PATTERNS PORFIDO	
	60x120	20 Facce differenti / Different Patterns
	60x90 2cm	12 Facce differenti / Different Patterns
	60x60	20 Facce differenti / Different Patterns
	30x60	40 Facce differenti / Different Patterns
	22,5x45	30 Facce differenti / Different Patterns
22,5x22,5	60 Facce differenti / Different Patterns	
10x60 Muretto	96 Facce differenti / Different Patterns	

PAVÉ DELLE ALPI 20MM



PIETRA LUSERNA

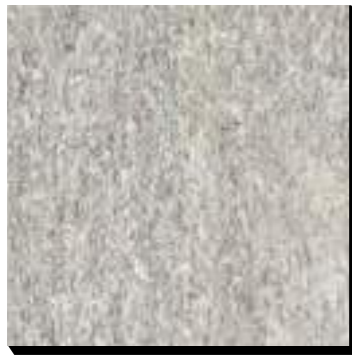

- 60x120 . 24"x48" Ret - GRIP
15184A - Pietra Luserna **PM - 77,50**
- 60x90 . 24"x36" Ret - GRIP
19555A - Pietra Luserna **PM - 76,50**

SESTRIERE



- 60x120 . 24"x48" Ret - GRIP
151841 - Sestriere **PM - 77,50**
- 60x90 . 24"x36" Ret - GRIP
195551 - Sestriere **PM - 76,50**
- 60x60 . 24"x24" Ret - GRIP
195681 - Sestriere **PM - 66,00**

QUARZO GRIGIO



- 60x90 . 24"x36" Ret - GRIP
195552 - Quarzo Grigio **PM - 76,50**
- 60x60 . 24"x24" Ret - GRIP
195682 - Quarzo Grigio **PM - 66,00**

QUARZO MULTICOLORE



- 60x90 . 24"x36" Ret - GRIP
195553 - Quarzo Multicolore **PM - 76,50**
- 60x60 . 24"x24" Ret - GRIP
195683 - Quarzo Multicolore **PM - 66,00**

VALMALENCO

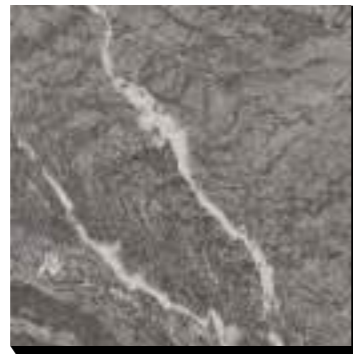

- 60x90 . 24"x36" Ret - GRIP
195556 - Valmalenco **PM - 76,50**

PORFIDO



- 60x120 . 24"x48" Ret - GRIP
151845 - Porfido **PM - 77,50**
- 60x90 . 24"x36" Ret - GRIP
195555 - Porfido **PM - 76,50**

COLORE STUCCHI "MAPEI" PER MURETTO 10X60

E' consigliata una stuccatura cementizia, per avere un migliore effetto di malta muratura, consigliamo l'aggiunta di un 25% di polvere di quarzo.

Cement grouting is recommended for a better masonry mortar effect; we suggest adding 25% quartz powder.

Un joint cimentaire est recommandé pour obtenir un meilleur effet de mortier de maçonnerie; nous recommandons l'ajout de 25% de poudre de quartz.

Es wird eine Zementverfugung empfohlen, um einen besseren Mauermörtel-Effekt zu erzielen; wir empfehlen die Zugabe von 25% Quarzpulver.

GRANITO	PIETRA LUSERNA	SESTRIERE	QUARZO GRIGIO	QUARZO MULTICOLORE	PIASENTINA	VALMALENCO	PORFIDO
n°110	n°110	n°110	n°110	n°110	n°110	n°110	n°110

9 mm PEZZI SPECIALI . SPECIAL PIECES . PIÈCES SPÉCIALES . SPEZIALTEILE



- Battiscopa
6x60 . 2"x24" SOFT GRIP
195521 - Sestriere
195522 - Quarzo Grigio
195523 - Quarzo Multicolore
195524 - Piasentina
195525 - Porfido
195526 - Valmalenco
195528 - Granito
19552A - Pietra Luserna

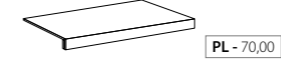

- Elemento a L
15x30 . 6"x12" GRIP
195531 - Sestriere
195532 - Quarzo Grigio
195533 - Quarzo Multicolore
195534 - Piasentina
195535 - Porfido
195536 - Valmalenco
195538 - Granito
19552A - Pietra Luserna

10 mm



- Gradino Costa Retta
33x120 . 13"x48" Ret - SOFT GRIP
199831 - Sestriere
199832 - Quarzo Grigio
199834 - Piasentina
199835 - Porfido
199836 - Valmalenco
199838 - Granito
19983A - Pietra Luserna

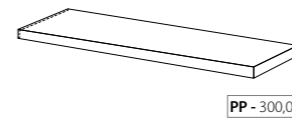

- Angolo Gradino Costa Retta Dx
33x120 . 13"x48" Ret - SOFT GRIP
199841 - Sestriere
199842 - Quarzo Grigio
199843 - Piasentina
199845 - Porfido
199846 - Valmalenco
199848 - Granito
19984A - Pietra Luserna

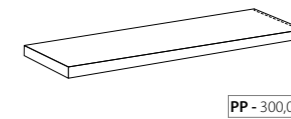

- Angolo Gradino Costa Retta Sx
33x120 . 13"x48" Ret - SOFT GRIP
199851 - Sestriere
199852 - Quarzo Grigio
199852 - Piasentina
199855 - Porfido
199856 - Valmalenco
199858 - Granito
19985A - Pietra Luserna

14 mm

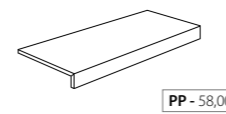

- Gradino Costa Retta
17x45 . 9"x18" GRIP
195661 - Sestriere
195662 - Quarzo Grigio
195663 - Quarzo Multicolore
195664 - Piasentina
195665 - Porfido
195666 - Valmalenco
195668 - Granito
19566A - Pietra Luserna

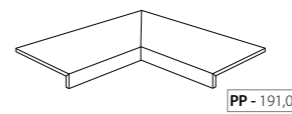

- Angolo Int. Gradino Costa Retta
17x45 . 9"x18" GRIP
195741 - Sestriere
195742 - Quarzo Grigio
195743 - Quarzo Multicolore
195744 - Piasentina
195745 - Porfido
195746 - Valmalenco
195748 - Granito
19574A - Pietra Luserna

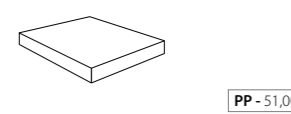

- Angolo Est. Gradino Costa Retta
17x45 . 9"x18" GRIP
195961 - Sestriere
195962 - Quarzo Grigio
195963 - Quarzo Multicolore
195964 - Piasentina
195965 - Porfido
195966 - Valmalenco
195968 - Granito
19596A - Pietra Luserna

20 mm

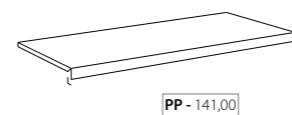

- Gradino Costa Retta
33x60 . 13"x24" Ret - GRIP
195591 - Sestriere
195592 - Quarzo Grigio
195593 - Quarzo Multicolore
195595 - Porfido
195596 - Valmalenco
19559A - Pietra Luserna

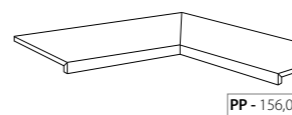

- Angolo Int. Gradino Costa Retta
33x60 . 13"x24" Ret - GRIP
195601 - Sestriere
195602 - Quarzo Grigio
195603 - Quarzo Multicolore
195605 - Porfido
195606 - Valmalenco
19560A - Pietra Luserna

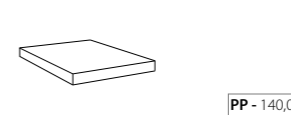

- Angolo Est. Gradino Costa Retta
33x33 . 13"x13" Ret - GRIP
195611 - Sestriere
195612 - Quarzo Grigio
195613 - Quarzo Multicolore
195615 - Porfido
195616 - Valmalenco
19561A - Pietra Luserna

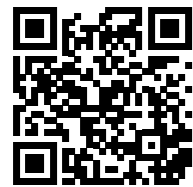

Istruzioni di posa
Laying instructions

124

MURETTO STUCCO FACILE

Sichenia presenta la novità tecnologica Stucco Facile. Questa soluzione unica consente di raggiungere un livello di finitura in cui il modulo di ogni singola piastrella scompare dalla vista una volta completata la posa. Nel muretto della Pavé delle Alpi i ciottoli hanno dimensioni e forme variegata: l'effetto visivo è simile a quello di un autentico muro in pietra naturale. Oltre alla sua estetica impressionante, il sistema Stucco Facile® offre anche vantaggi pratici. La sua progettazione intelligente semplifica il processo di installazione, garantendo una posa agevole e un risultato finale di alta qualità.

Sichenia presents the technological innovation "Stucco Facile". This unique solution allows achieving a finishing level where the module of each individual tile disappears from view once the laying is complete. In the wall of "Pavé delle Alpi", the pebbles have varied sizes and shapes: the visual effect is similar to that of an authentic natural stone wall. In addition to its impressive aesthetics, the "Stucco Facile" system also offers practical advantages. Its intelligent design simplifies the installation process, ensuring easy laying and a final result of high quality.

Sichenia présente l'innovation technologique "Stucco Facile". Cette solution unique permet d'atteindre un niveau de finition où le module de chaque carreau individuel disparaît de la vue une fois la pose terminée. Dans le mur de "Pavé delle Alpi", les cailloux ont des tailles et des formes variées: l'effet visuel est similaire à celui d'un véritable mur en pierre naturelle. En plus de son esthétique impressionnante, le système "Stucco Facile" offre également des avantages pratiques. Sa conception intelligente simplifie le processus d'installation, garantissant une pose facile et un résultat final de haute qualité.

Sichenia präsentiert die technologische Neuerung "Stucco Facile". Diese einzigartige Lösung ermöglicht einen Veredelungsgrad, bei dem das Modul jeder einzelnen Fliese nach Abschluss der Verlegung aus dem Blickfeld verschwindet. In der Mauer von "Pavé delle Alpi" haben die Kiesel unterschiedliche Größen und Formen: Der visuelle Effekt ähnelt dem eines authentischen Natursteinmurs. Neben ihrer beeindruckenden Ästhetik bietet das "Stucco Facile"-System auch praktische Vorteile. Das intelligente Design vereinfacht den Installationsprozess und gewährleistet eine einfache Verlegung sowie ein hochwertiges Endresultat.

125

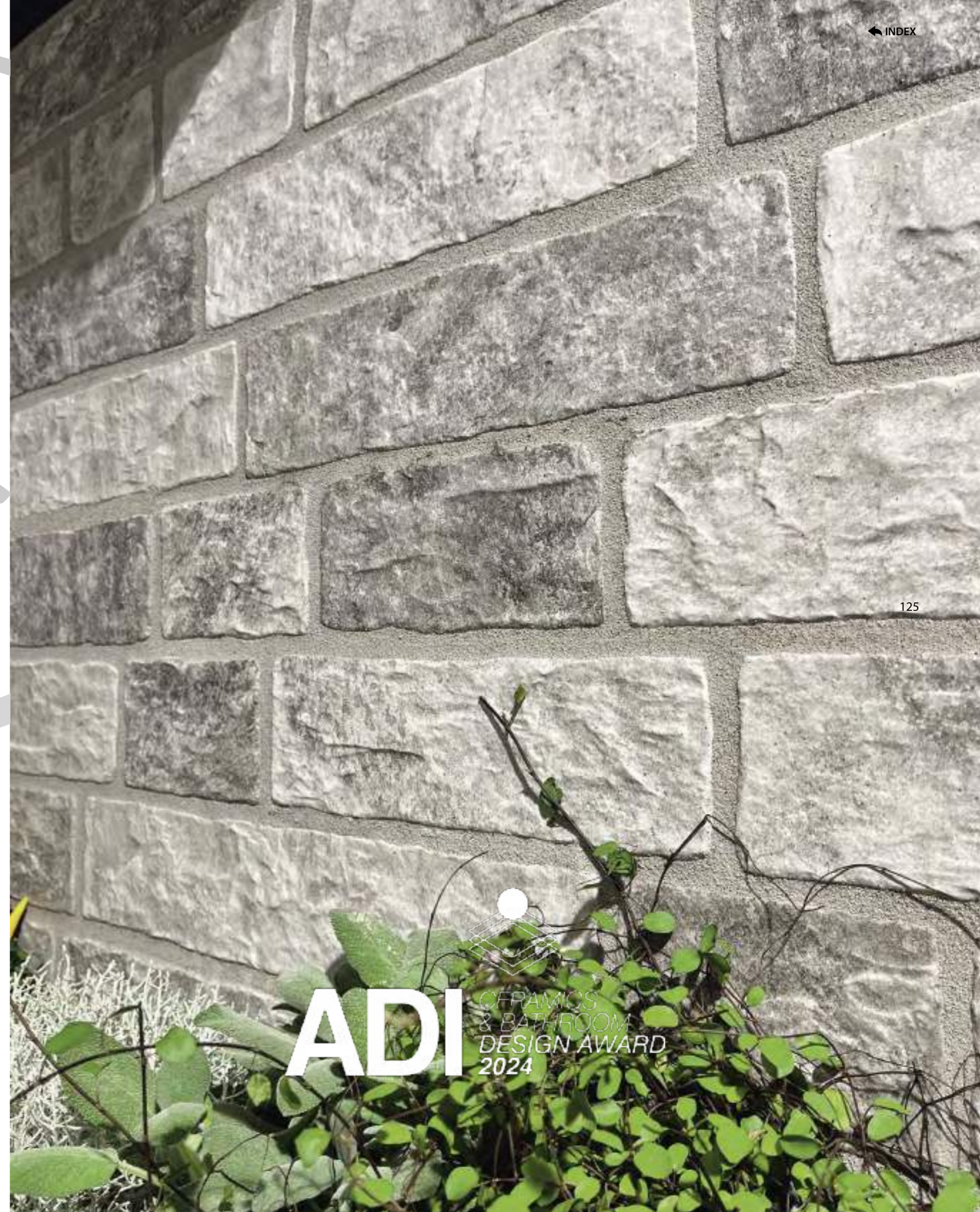

ADI CERAMICS & BATHROOM DESIGN AWARD 2024

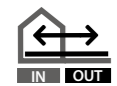

BIANCO BEIGE ORO GRIGIO

AMBOISE

Amboise combina l'eleganza del calcare naturale con finiture Straight e Chipped, offrendo soluzioni versatili per ambienti interni e progetti contract.

Amboise blends the elegance of natural limestone with Straight and Chipped finishes, offering versatile solutions for interiors and contract projects.

Amboise allie l'élégance du calcaire naturel à des finitions Straight et Chipped, proposant des solutions polyvalentes pour les espaces intérieurs et les projets contractuels.

Amboise vereint die Eleganz von Naturkalkstein mit Straight- und Chipped-Oberflächen und bietet vielseitige Lösungen für Innenräume und Contract-Projekte.



AMBOISE STRAIGHT-EDGE



BIANCO



192731 - 90x90 . 36"x36" Ret - SOFT GRIP **PM - 56,70**
194041 - 90x90 . 36"x36" Ret - LAPPATO **PM - 74,00**

BEIGE



192732 - 90x90 . 36"x36" Ret -SOFT GRIP **PM - 56,70**
194042 - 90x90 . 36"x36" Ret - LAPPATO **PM - 74,00**

128



192781 - 60x120 . 24"x48" Ret - SOFT GRIP **PM - 56,70**



193221 - 60x90 . 24"x36" Ret - SOFT GRIP **PM - 50,00**



192782 - 60x120 . 24"x48" Ret - SOFT GRIP **PM - 56,70**



193222 - 60x90 . 24"x36" Ret - SOFT GRIP **PM - 50,00**

129

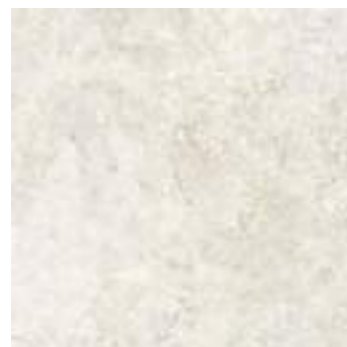

192791 - 60x60 . 24"x24" Ret - SOFT GRIP **PM - 46,70**



193541 - 30x60 . 12"x24" Ret - SOFT GRIP **PM - 46,70**



192821 - 30x30 . 12"x12" (5x5 . 2"x2")
Modulo rete Ret - SOFT GRIP
PP - 18,00

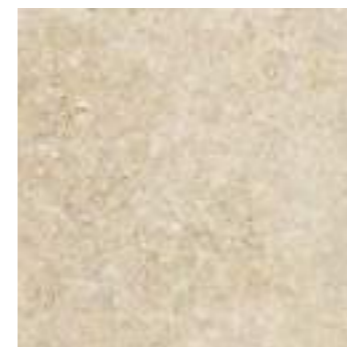

192792 - 60x60 . 24"x24" Ret - SOFT GRIP **PM - 46,70**



193542 - 30x60 . 12"x24" Ret - SOFT GRIP **PM - 46,70**

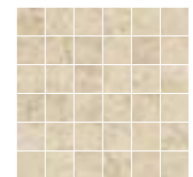

192822 - 30x30 . 12"x12" (5x5 . 2"x2")
Modulo rete Ret - SOFT GRIP
PP - 18,00

PEZZI SPECIALI 9MM . SPECIAL PIECES . PIÈCES SPÉCIALES . SPEZIALTEILE



Battiscopa
7x60 . 2,5"x24" Ret - SOFT GRIP
192831 - Bianco
192832 - Beige

PL - 13,50

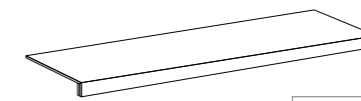

Gradino Costa Retta
33x120 . 13"x48" Ret - SOFT GRIP
192841 - Bianco
192842 - Beige

PP - 250,00

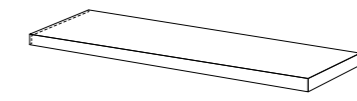

Angolo Gradino Costa Retta DX
33x120 . 13"x48" Ret - SOFT GRIP
192851 - Bianco
192852 - Beige

PP - 300,00

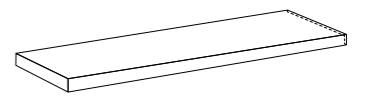

Angolo Gradino Costa Retta SX
33x120 . 13"x48" Ret - SOFT GRIP
192861 - Bianco
192862 - Beige

PP - 300,00

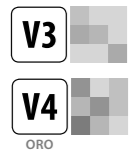

SVILUPPO GRAFICO / PATTERNS

- 90x90 **20** Facce differenti / Different Patterns
- 60x120 **20** Facce differenti / Different Patterns
- 60x90 **24** Facce differenti / Different Patterns
- 60x60 **33** Facce differenti / Different Patterns
- 30x60 **66** Facce differenti / Different Patterns

ATTENZIONE . BE CAREFUL . ATTENTION . ACHTUNG

Nella posa modulare è obbligatoria la fuga di 2 mm.
 When laying different sizes tiles envisaged for modular laying, a gap of 2 mm is required.
 La pose modulaire exige obligatoirement un joint de 2 mm.
 Bei Modul-Verlegung sind 2 mm Fuge empfehlenswert.

AMBOISE STRAIGHT-EDGE



ORO



192735 - 90x90 . 36"x36" Ret - SOFT GRIP **PM - 56,70**
194045 - 90x90 . 36"x36" Ret - LAPPATO **PM - 74,00**



192785 - 60x120 . 24"x48" Ret - SOFT GRIP **PM - 56,70**



193225 - 60x90 . 24"x36" Ret - SOFT GRIP **PM - 50,00**



192795 - 60x60 . 24"x24" Ret - SOFT GRIP **PM - 46,70**



193545 - 30x60 . 12"x24" Ret - SOFT GRIP **PM - 46,70**



192825 - 30x30 . 12"x12" (5x5 . 2"x2")
 Modulo rete Ret - SOFT GRIP **PP - 18,00**

PEZZI SPECIALI 9MM . SPECIAL PIECES . PIÈCES SPÉCIALES . SPEZIALTEILE

infotech p. 280



PL - 13,50

Battiscopa
 7x60 . 2,5"x24" Ret - SOFT GRIP
192835 - Oro

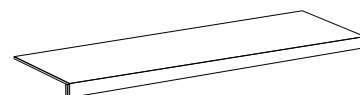

PP - 250,00

Gradino Costa Retta
 33x120 . 13"x48" Ret - SOFT GRIP
192845 - Oro

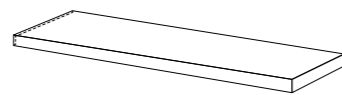

PP - 300,00

Angolo Gradino Costa Retta DX
 33x120 . 13"x48" Ret - SOFT GRIP
192855 - Oro

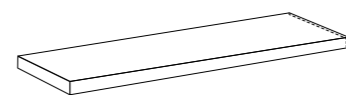

PP - 300,00

Angolo Gradino Costa Retta SX
 33x120 . 13"x48" Ret - SOFT GRIP
192865 - Oro

AMBOISE CHIPPED-EDGE



BIANCO



193241 - 90x90 . 36"x36" Chipped Ret - SMOOTH **PM - 58,00**



192691 - 30x60 . 12"x24" Chipped Ret - SMOOTH **PM - 48,00**



192641 - 60x90 . 24"x36" Chipped Ret - SMOOTH **PM - 51,50**
193521 - 60x90 . 24"x36" Chipped Ret - GRIP **PM - 51,50**

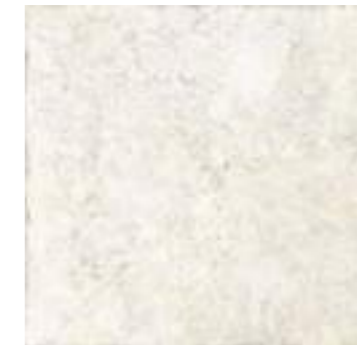

192661 - 60x60 . 24"x24" Chipped Ret - SMOOTH **PM - 48,00**

PEZZI SPECIALI 9MM . SPECIAL PIECES . PIÈCES SPÉCIALES . SPEZIALTEILE

infotech p. 280



PL - 13,50

Battiscopa
 7x60 . 2,5"x24" Ret - SOFT GRIP
192831 - Bianco

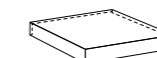

PP - 156,00

Angolo Gradino Costa Retta
 33x33 . 13"x13" Chipped Ret - SMOOTH
194411 - Bianco



PP - 145,00

Gradino Costa Retta
 33x60 . 13"x24" Chipped Ret - SMOOTH
194401 - Bianco

AMBOISE CHIPPED-EDGE



BEIGE



193242 - 90x90 . 36"x36" Chipped Ret - SMOOTH **PM - 58,00**

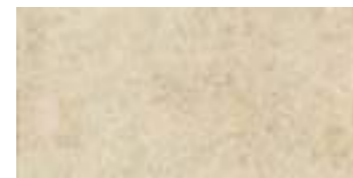

192692 - 30x60 . 12"x24" Chipped Ret - SMOOTH **PM - 48,00**



192642 - 60x90 . 24"x36" Chipped Ret - SMOOTH **PM - 51,50**

193522 - 60x90 . 24"x36" Chipped Ret - GRIP **PM - 51,50**



192662 - 60x60 . 24"x24" Chipped Ret - SMOOTH **PM - 48,00**

ORO



193245 - 90x90 . 36"x36" Chipped Ret - SMOOTH **PM - 58,00**



192695 - 30x60 . 12"x24" Chipped Ret - SMOOTH **PM - 48,00**



192645 - 60x90 . 24"x36" Chipped Ret - SMOOTH **PM - 51,50**

193525 - 60x90 . 24"x36" Chipped Ret - GRIP **PM - 51,50**



192665 - 60x60 . 24"x24" Chipped Ret - SMOOTH **PM - 48,00**

PEZZI SPECIALI 9MM . SPECIAL PIECES . PIÈCES SPÉCIALES . SPEZIALTEILE

infotech p. 280



PL - 13,50

Battiscopa
7x60 . 2,5"x24" Ret - SOFT GRIP
192832 - Beige
192835 - Oro

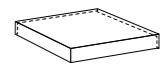

PP - 156,00

Angolo Gradino Costa Retta
33x33 . 13"x13" Chipped Ret - SMOOTH
194412 - Beige
194415 - Oro



PP - 145,00

Gradino Costa Retta
33x60 . 13"x24" Chipped Ret - SMOOTH
194402 - Beige
194405 - Oro



SVILUPPO GRAFICO / PATTERNS

90x90 **20** Facce differenti / Different Patterns
60x90 **24** Facce differenti / Different Patterns
60x60 **33** Facce differenti / Different Patterns
30x60 **66** Facce differenti / Different Patterns

ATTENZIONE . BE CAREFUL . ATTENTION . ACHTUNG

Nella posa modulare è obbligatoria la fuga di 2 mm.
When laying different sizes tiles envisaged for modular laying, a gap of 2 mm is required.
La pose modulaire exige obligatoirement un joint de 2 mm.
Bei Modul- Verlegung sind 2 mm Fuge empfehlenswert.

AMBOISE CHIPPED-EDGE 20MM



BIANCO



192881 - 60x90 . 24"x36" Chipped Ret - GRIP PM - 76,50

BEIGE



192882 - 60x90 . 24"x36" Chipped Ret - GRIP PM - 76,50

ORO



192885 - 60x90 . 24"x36" Chipped Ret - GRIP PM - 76,50

GRIGIO



192883 - 60x90 . 24"x36" Chipped Ret - GRIP PM - 76,50



192901 - 90x90 . 36"x36" Chipped Ret - GRIP PM - 85,00



192902 - 90x90 . 36"x36" Chipped Ret - GRIP PM - 85,00



192905 - 90x90 . 36"x36" Chipped Ret - GRIP PM - 85,00



192903 - 90x90 . 36"x36" Chipped Ret - GRIP PM - 85,00

PEZZI SPECIALI 20MM . SPECIAL PIECES . PIÈCES SPÉCIALES . SPEZIALTEILE

p. 280

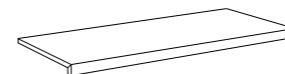

Gradino costa retta PP - 265,00
 33x90 . 13"x36" Chipped Ret - GRIP
 192911 - Bianco
 192912 - Beige
 192915 - Oro
 192913 - Grigio

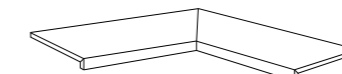

Angolo Int. Gradino Costa Retta PP - 620,00
 33x90 . 13"x36" Chipped Ret - GRIP
 192921 - Bianco
 192922 - Beige
 192925 - Oro
 192923 - Grigio



Angolo Est. Gradino Costa Retta PP - 140,00
 33x33 . 13"x13" Chipped Ret - GRIP
 192931 - Bianco
 192932 - Beige
 192935 - Oro
 192933 - Grigio



ORO

SVILUPPO GRAFICO / PATTERNS

90x90 **20** Facce differenti / Different Patterns
 60x90 **24** Facce differenti / Different Patterns

136



PAVÉ WALL 30.90

Con le sue 3 strutture Ribbed, Velvet e Raws da' forma all'argilla valorizzandola, rendendola materia pura elegante e raffinata, rustica e artigianale.

With its three textures Ribbed, Velvet, and Raws it shapes clay, highlighting its essence and transforming it into a material that is elegant and refined, yet rustic and artisanal.

Avec ses trois textures Ribbed, Velvet et Raws elle met en forme l'argile, révélant sa pureté et transformant la matière en un matériau à la fois élégant, raffiné, rustique et artisanal.

Mit seinen drei Strukturen Ribbed, Velvet und Raws formt es Ton und betont dessen Wesen, sodass das Material elegant und fein, zugleich rustikal und handwerklich wirkt.

137



PAVÉ WALL 30.90 VELVET



190001 - 30x90 . 12"x36" Cream Ret - Velvet
PM - 62,00



190005 - 30x90 . 12"x36" Amazing Grey Ret - Velvet
PM - 62,00



190002 - 30x90 . 12"x36" Greige Ret - Velvet
PM - 62,00

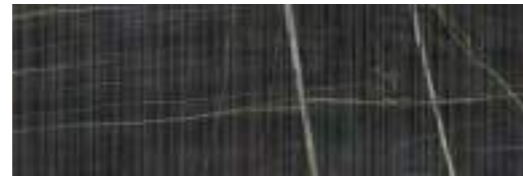

190006 - 30x90 . 12"x36" Saint Laurent Ret - Velvet
PM - 62,00



190004 - 30x90 . 12"x36" Calacatta Gold Ret - Velvet
PM - 62,00

PAVÉ WALL 30.90 RIBBED



192811 - 30x90 . 12"x36" Bianco Ret - Ribbed
PM - 62,00



192812 - 30x90 . 12"x36" Beige Ret - Ribbed
PM - 62,00



192815 - 30x90 . 12"x36" Oro Ret - Ribbed
PM - 62,00



192813 - 30x90 . 12"x36" Grigio Ret - Ribbed
PM - 62,00

V3 SVILUPPO GRAFICO / PATTERNS
30x90 48 Facce differenti / Different Patterns

V4 ORO

PAVÉ WALL 30.90 ROWS

GRES PORCELLANATO . PORCELAIN STONEWARE . GRÈS CÉRAME . FEINSTEINZEUG



189991 - 30x90 . 12"x36" Zebrino Ret - Rows
PM - 62,00



189992 - 30x90 . 12"x36" White Ret - Rows
PM - 62,00



189993 - 30x90 . 12"x36" Sunshine Ret - Rows
PM - 62,00

V2 SVILUPPO GRAFICO / PATTERNS
30x90 10 Facce differenti / Different Patterns

V2 SVILUPPO GRAFICO / PATTERNS
30x90 Cream 8 Facce differenti / Different Patterns
30x90 Greige 8 Facce differenti / Different Patterns
30x90 Calacatta Gold 10 Facce differenti / Different Patterns
30x90 Amazing Grey 10 Facce differenti / Different Patterns
30x90 Saint Laurent 14 Facce differenti / Different Patterns

140



CREAM GREIGE ASH

AR_GENT

Ar_gent celebra la naturale bellezza del limestone Iberico, reinterpretato con toni neutri, texture delicate e riflessi 3D per soluzioni eleganti e contemporanee.

Ar_gent celebrates the natural beauty of Iberian limestone, reimagined with neutral tones, delicate textures, and subtle 3D effects for elegant, contemporary spaces.

Ar_gent met en valeur la beauté naturelle du calcaire ibérique, réinterprété avec des tons neutres, des textures délicates et des effets 3D subtils pour des espaces élégants et contemporains.

Ar_gent hebt die natürliche Schönheit des iberischen Limestones hervor, neu interpretiert mit neutralen Tönen, feinen Texturen und dezenten 3D-Effekten für elegante, zeitgemäße Räume.



141

AR_GENT

CREAM



184442 - 60x120 . 24"x48"
Ret - MATT PM - 50,00



185532 - 90x90 . 36"x36"
Ret - MATT PM - 50,00



184462 - 60x60 . 24"x24"
Ret - MATT PM - 39,90



GREIGE



184443 - 60x120 . 24"x48"
Ret - MATT PM - 50,00



185533 - 90x90 . 36"x36"
Ret - MATT PM - 50,00



184463 - 60x60 . 24"x24"
Ret - MATT PM - 39,90

142

143

V2 **SVILUPPO GRAFICO / PATTERNS**
 60x120 **5** Facce differenti / Different Patterns
 90x90 **6** Facce differenti / Different Patterns
 60x60 **10** Facce differenti / Different Patterns

PEZZI SPECIALI . SPECIAL PIECES . PIÈCES SPÉCIALES . SPEZIALTEILE

infotech p. 280



Battiscopa
7x60 . 2,5"x24" Ret - MATT
185132 - Cream

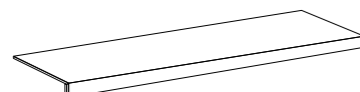

Gradino Costa Retta
33x120 . 13"x48" Ret - MATT
185142 - Cream

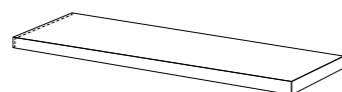

Angolo Gradino Costa Retta DX
33x120 . 13"x48" Ret - MATT
185152 - Cream

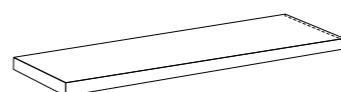

Angolo Gradino Costa Retta SX
33x120 . 13"x48" Ret - MATT
185162 - Cream

infotech p. 280



Battiscopa
7x60 . 2,5"x24" Ret - MATT
185133 - Greige

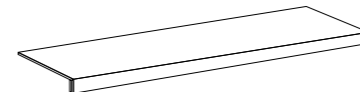

Gradino Costa Retta
33x120 . 13"x48" Ret - MATT
185143 - Greige

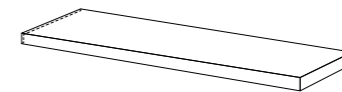

Angolo Gradino Costa Retta DX
33x120 . 13"x48" Ret - MATT
185153 - Greige

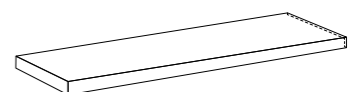

Angolo Gradino Costa Retta SX
33x120 . 13"x48" Ret - MATT
185163 - Greige

AR_GENT



ASH



184441 - 60x120 . 24"x48"
Ret - MATT PM - 50,00



185531 - 90x90 . 36"x36"
Ret - MATT PM - 50,00



184461 - 60x60 . 24"x24"
Ret - MATT PM - 39,90

144

AR_GENT 20MM



GREIGE



186033 - 90x90 . 36"x36"
Ret - GRIP PM - 77,50

ASH



186031 - 90x90 . 36"x36"
Ret - GRIP PM - 77,50

CREAM



197122 - 90x90 . 36"x36"
Ret - GRIP PM - 77,50

145

V2 **SVILUPPO GRAFICO / PATTERNS**
60x120 **5** Facce differenti / Different Patterns
90x90 **6** Facce differenti / Different Patterns
60x60 **10** Facce differenti / Different Patterns

PEZZI SPECIALI . SPECIAL PIECES . PIÈCES SPÉCIALES . SPEZIALTEILE

infotech p. 280



Battiscopa
7x60 . 2,5"x24" Ret - MATT
185131 - Ash PL - 13,50

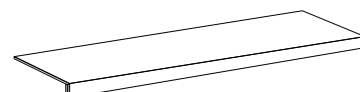

Gradino Costa Retta
33x120 . 13"x48" Ret - MATT
185141 - Ash PP - 250,00

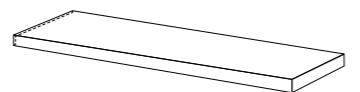

Angolo Gradino Costa Retta DX
33x120 . 13"x48" Ret - MATT
185151 - Ash PP - 300,00

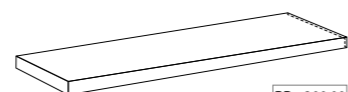

Angolo Gradino Costa Retta SX
33x120 . 13"x48" Ret - MATT
185161 - Ash PP - 300,00

infotech p. 280

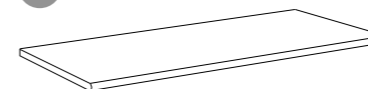

Gradino Toro
30x90 . 12"x36" Ret - GRIP PP - 176,00
185073 - Greige
185071 - Ash
185072 - Cream

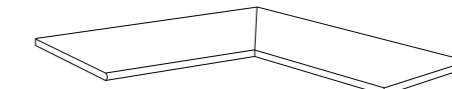

Angolo Grad. Toro Interno Dx-Sx
30x90 . 12"x36" Ret - GRIP PP - 480,00
185083 - Greige
185081 - Ash
185082 - Cream

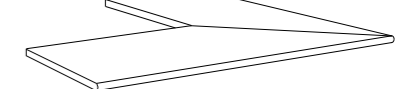

Angolo Grad. Toro Esterno Dx-Sx
30x90 . 12"x36" Ret - GRIP PP - 480,00
185093 - Greige
185091 - Ash
185092 - Cream

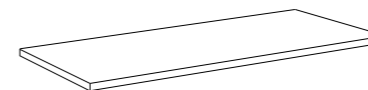

Gradino Costa Lucida
30x90 . 12"x36" Ret - GRIP PP - 176,00
185103 - Greige
185101 - Ash
185102 - Cream

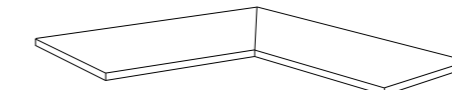

Angolo Grad. Costa Lucida Int. Dx-Sx
30x90 . 12"x36" Ret - GRIP PP - 480,00
185113 - Greige
185111 - Ash
185112 - Cream

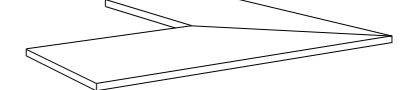

Angolo Grad. Costa Lucida Est. Dx-Sx
30x90 . 12"x36" Ret - GRIP PP - 480,00
185123 - Greige
185121 - Ash
185122 - Cream



BIANCO ANTRACITE TAUPE

CHATEAUX

Chateaux combina la forza della pietra e l'innovazione ceramica, offrendo superfici versatili e soluzioni progettuali per interni ed esterni.

Chateaux combines the strength of natural stone with ceramic innovation, offering versatile surfaces and design solutions for both interiors and exteriors.

Chateaux allie la robustesse de la pierre à l'innovation céramique, proposant des surfaces polyvalentes et des solutions de conception pour l'intérieur comme pour l'extérieur.

Chateaux vereint die Kraft von Naturstein mit keramischer Innovation und bietet vielseitige Oberflächen sowie Gestaltungslösungen für Innen- und Außenbereiche.



CHATEAUX



BIANCO



181225 - 30x60 . 12"x24" Ret - R10 **PM - 46,70**



181195 - 60x60 . 24"x24" Ret - R10 **PM - 46,70**



181215 - 60x90 . 24"x36" Ret - R10 **PM - 50,00**



181895 - 90x90 . 36"x36" Ret - R10 **PM - 56,70**



181245 - 30x30 . 12"x12" (5x5 . 2"x2")
Modulo rete Ret - R10
PP - 18,00

ANTRACITE



181224 - 30x60 . 12"x24" Ret - R10 **PM - 46,70**



181194 - 60x60 . 24"x24" Ret - R10 **PM - 46,70**



181214 - 60x90 . 24"x36" Ret - R10 **PM - 50,00**

185414 - 60x90 . 24"x36" Ret - GRIP **PM - 50,00**



181894 - 90x90 . 36"x36" Ret - R10 **PM - 56,70**

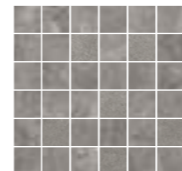

181244 - 30x30 . 12"x12" (5x5 . 2"x2")
Modulo rete Ret - R10
PP - 18,00

TAUPE



181222 - 30x60 . 12"x24" Ret - R10 **PM - 46,70**



181192 - 60x60 . 24"x24" Ret - R10 **PM - 46,70**



181212 - 60x90 . 24"x36" Ret - R10 **PM - 50,00**

185412 - 60x90 . 24"x36" Ret - GRIP **PM - 50,00**



181242 - 30x30 . 12"x12" (5x5 . 2"x2")
Modulo rete Ret - R10
PP - 18,00



181892 - 90x90 . 36"x36" Ret - R10 **PM - 56,70**

V3	SVILUPPO GRAFICO / PATTERNS
90x90 Taupe/Bianco	7 Facce differenti / Different Patterns
90x90 Antracite	6 Facce differenti / Different Patterns
60x90	12 Facce differenti / Different Patterns
60x60	24 Facce differenti / Different Patterns
30x60	48 Facce differenti / Different Patterns

ATTENZIONE . BE CAREFUL . ATTENTION . ACHTUNG
 Nella posa modulare è obbligatoria la fuga di 2 mm.
 When laying different sizes tiles envisaged for modular laying,
 a gap of 2 mm is required.
 La pose modulaire exige obligatoirement un joint de 2 mm.
 Bei Modul-Verlegung sind 2 mm Fuge empfehlenswert.

PEZZI SPECIALI 9MM . SPECIAL PIECES . PIÈCES SPÉCIALES . SPEZIALTEILE



infotech p. 280

PEZZI SPECIALI 9MM . SPECIAL PIECES . PIÈCES SPÉCIALES . SPEZIALTEILE



infotech p. 280

CHATEAUX 20MM



ANTRACITE



182204 - 60x90 . 24"x36" Ret - GRIP PM - 76,50



182214 - 90x90 . 36"x36" Ret - GRIP PM - 77,50



181534 - 60x60 . 24"x24" Ret - GRIP PM - 66,00

TAUPE



182202 - 60x90 . 24"x36" Ret - GRIP PM - 76,50



182212 - 90x90 . 36"x36" Ret - GRIP PM - 77,50



181532 - 60x60 . 24"x24" Ret - GRIP PM - 66,00

150

151

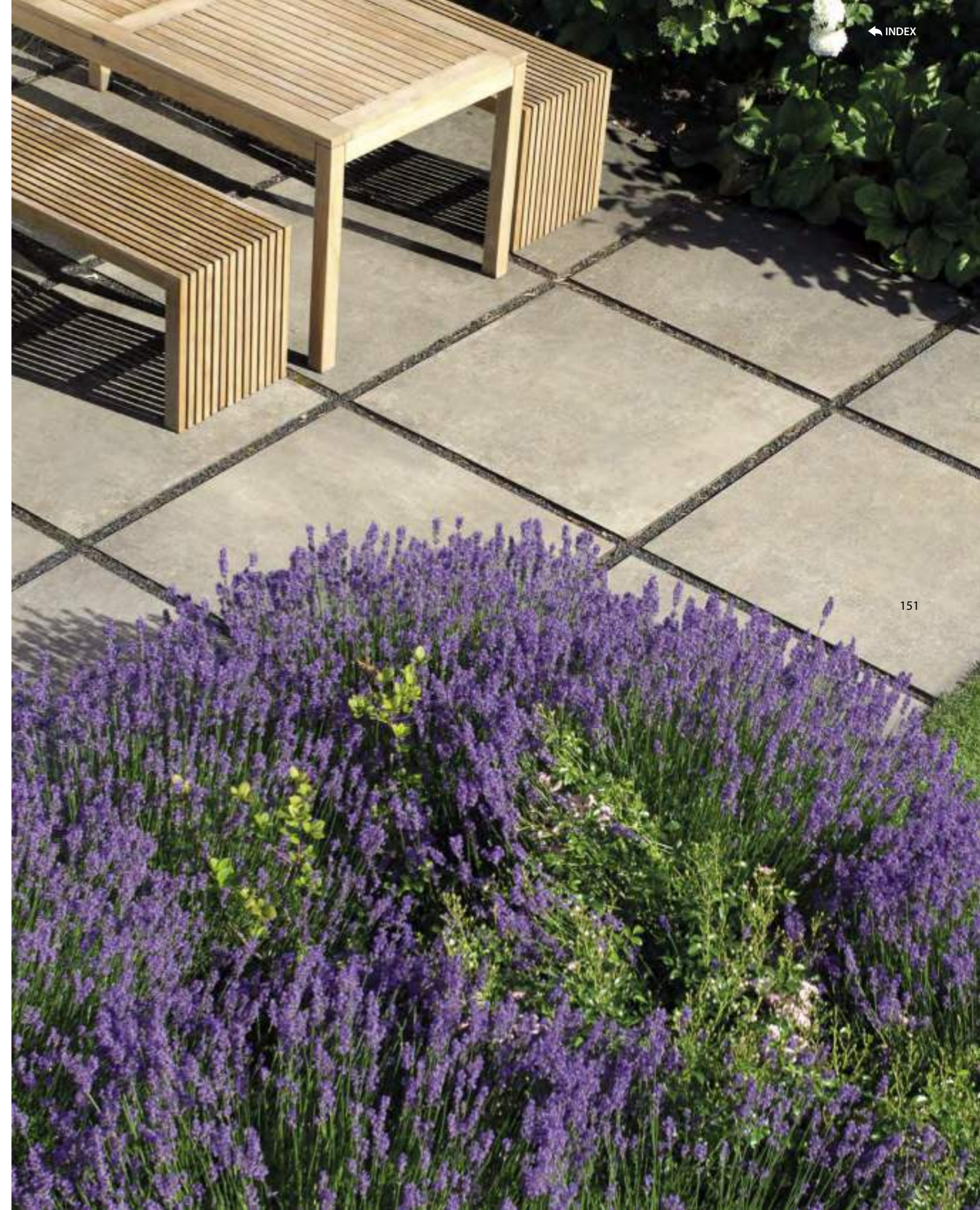

PEZZI SPECIALI . SPECIAL PIECES . PIÈCES SPÉCIALES . SPEZIALTEILE

infotech p. 280

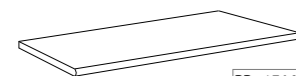

PP - 176,00
Gradino Toro
30x90 . 12"x36" Ret - GRIP
184244 - Antracite
184242 - Taupe

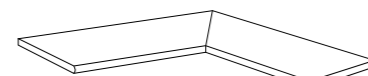

PP - 480,00
Angolo Grad. Toro Interno Dx-Sx
30x90 . 12"x36" Ret - GRIP
184254 - Antracite
184252 - Taupe



PP - 480,00
Angolo Grad. Toro Esterno Dx-Sx
30x90 . 12"x36" Ret - GRIP
184264 - Antracite
184262 - Taupe

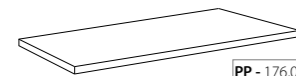

PP - 176,00
Gradino Costa Lucida
30x90 . 12"x36" Ret - GRIP
184274 - Antracite
184272 - Taupe



PP - 480,00
Angolo Grad. Costa Lucida Interno Dx-Sx
30x90 . 12"x36" Ret - GRIP
184284 - Antracite
184282 - Taupe



PP - 480,00
Angolo Grad. Costa Lucida Esterno Dx-Sx
30x90 . 12"x36" Ret - GRIP
184294 - Antracite
184292 - Taupe

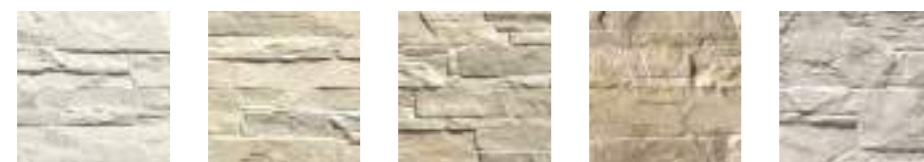

BIANCO CORDA SAVANA MATTONE FUMO

PAVÉ WALL DOLMEN

Pavé Wall Dolmen fonde la forza della pietra naturale con finiture moderne e formati calibrati per valorizzare le pareti in contesti residenziali e contract.

Pavé Wall Dolmen blends the strength of natural stone with modern finishes and carefully sized formats, enhancing walls in both residential and contract settings.

Pavé Wall Dolmen associe la robustesse de la pierre naturelle à des finitions modernes et des formats étudiés, mettant en valeur les murs dans des espaces résidentiels et contractuels.

Pavé Wall Dolmen vereint die Kraft des Natursteins mit modernen Oberflächen und präzise abgestimmten Formaten, um Wände in Wohn- und Contract-Bereichen zu betonen.



PAVÉ WALL DOLMEN



BIANCO



T 4624 - 22,5x45 . 9"x18"
Muretto **PM - 45,00**



1124 - 11x45 . 4,5"x18"
Muretto **PM - 57,50**

CORDA



T 4620 - 22,5x45 . 9"x18"
Muretto **PM - 45,00**



1120 - 11x45 . 4,5"x18"
Muretto **PM - 57,50**

SAVANA



T 4621 - 22,5x45 . 9"x18"
Muretto **PM - 45,00**



1121 - 11x45 . 4,5"x18"
Muretto **PM - 57,50**

MATTONE



T 4623 - 22,5x45 . 9"x18"
Muretto **PM - 45,00**



1123 - 11x45 . 4,5"x18"
Muretto **PM - 57,50**

FUMO



T 4622 - 22,5x45 . 9"x18"
Muretto **PM - 45,00**



1122 - 11x45 . 4,5"x18"
Muretto **PM - 57,50**

154

155

V3 **SVILUPPO GRAFICO / PATTERNS**
22,5x45 **8** Facce differenti / Different Patterns
11x45 **16** Facce differenti / Different Patterns

COLORE STUCCHI "MAPEI"

"Mapei" grout colours.
Couleur des mortiers de jointoiment "Wall Mapei".
Fugenfarben "Mapei".

BIANCO	CORDA	SAVANA	MATTONE	FUMO
n°103	n°111 50% n°131 50%	n°111 50% n°131 50%	n°132 50% n°142 50%	n°111

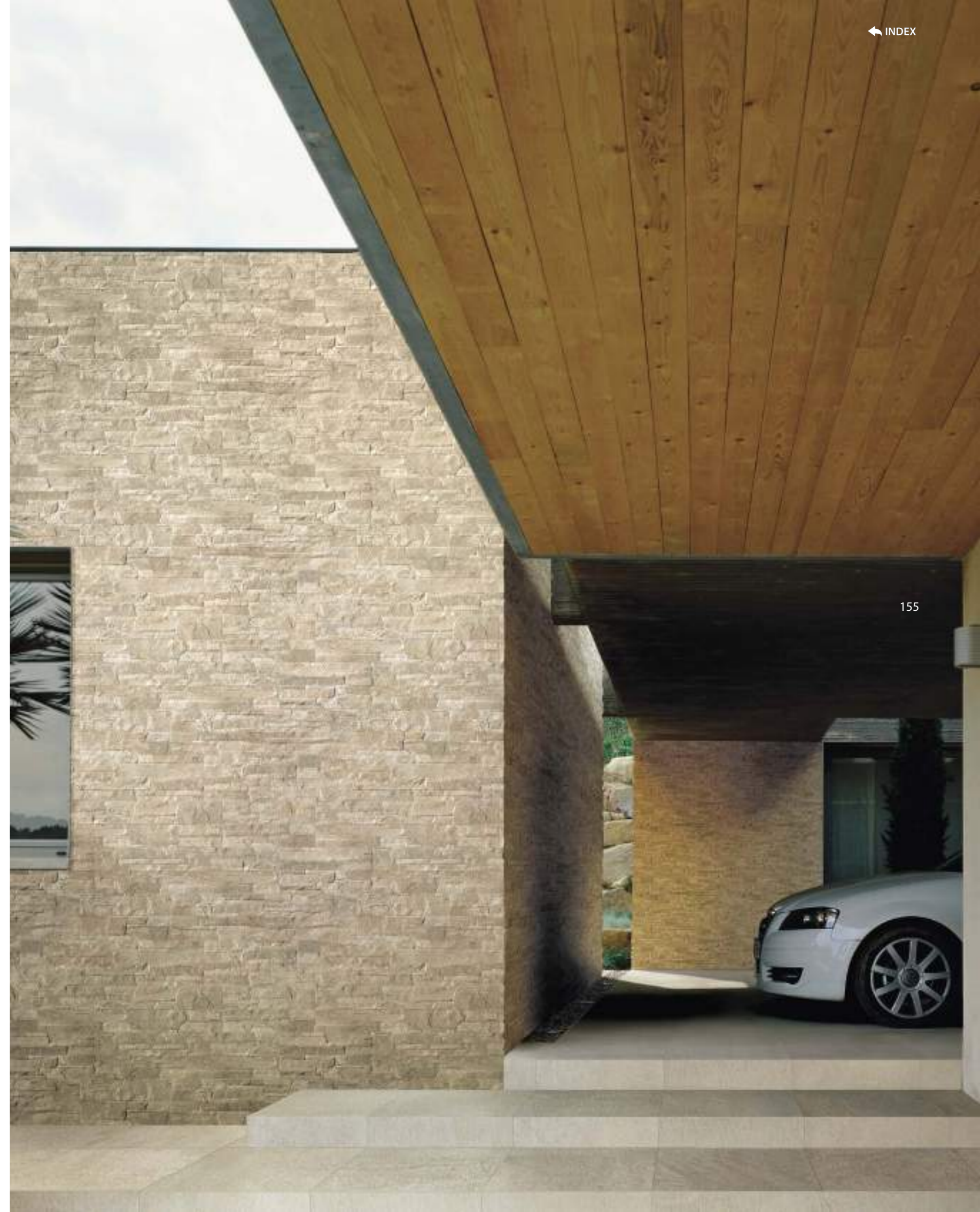

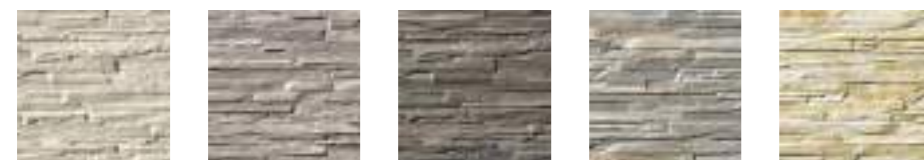

BIANCO CENERE GRAFITE MUSCHIO SABBIA

PAVÉ WALL HOUSE

La collezione di muretti combina texture materiche e formati calibrati per pareti interne ed esterne, offrendo soluzioni versatili per progetti residenziali contemporanei.

The wall collection combines textured surfaces and carefully sized formats for both interior and exterior walls, offering versatile solutions for contemporary residential projects.

La collection de murs associe des textures riches et des formats étudiés pour les murs intérieurs et extérieurs, proposant des solutions polyvalentes pour des projets résidentiels contemporains.

Die Mauersammlung kombiniert strukturierte Oberflächen und präzise abgestimmte Formate für Innen- und Außenwände und bietet vielseitige Lösungen für moderne Wohnprojekte.



PAVÉ WALL HOUSE



BIANCO



1659 - 16,5x41 .6"x16"
Muretto PM -46,00

CENERE



1657 - 16,5x41 .6"x16"
Muretto PM -46,00

GRAFITE



1658 - 16,5x41 .6"x16"
Muretto PM -46,00

SABBIA



1655 - 16,5x41 .6"x16"
Muretto PM -46,00

MUSCHIO



1656 - 16,5x41 .6"x16"
Muretto PM -46,00

158

V2  **SVILUPPO GRAFICO / PATTERNS**
16,5x41 **6** Facce differenti / Different Patterns

COLORE STUCCHI "MAPEI"

"Mapei" grout colours.
Couleur des mortiers de jointoiement "Mapei".
Fugenfarben "Mapei".

BIANCO

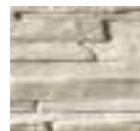

n°103

SABBIA



n°130

CENERE

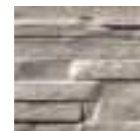

n°110

MUSCHIO

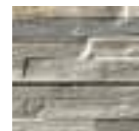

n°110

GRAFITE

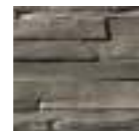

n°113



159



MARBLEMARMI

161

NAVONA	162
PRESTIGE	166
COPICO	174



BIANCO BEIGE

NAVONA

Navona reinterpreta il fascino del travertino in delicate tonalità di bianco e beige, con texture materiche e superfici tridimensionali che donano profondità e armonia agli spazi.

Navona reinterprets the charm of travertine in soft shades of white and beige, with textured and three-dimensional surfaces that bring depth and harmony to any space.

Navona réinterprète le charme du travertin dans de douces nuances de blanc et de beige, avec des surfaces texturées et tridimensionnelles qui apportent profondeur et harmonie à chaque espace.

Navona interpretiert den Charme von Travertin in sanften Weiß- und Beigetönen, mit strukturierten und dreidimensionalen Oberflächen, die jedem Raum Tiefe und Harmonie verleihen.



NAVONA



BIANCO



199481 - 60x120 . 24"x48"
Ret - SATIN 3D PM - 51,50

199521 - 60x120 . 24"x48"
Ret - Bocciardato SOFT GRIP PM - 51,50



199541 - 60x120 . 24"x48"
Ret - Bambus SATIN 3D PM - 63,00



199491 - 60x60 . 24"x24"
Ret - SATIN 3D PM - 40,50



199501 30x60 . 12"x24"
Ret - SATIN 3D PM - 40,50



199561 - 20x60 . 8"x24"
Pavé Wall Muretto - ROWS 10mm PM - 50,00

164

BEIGE



199482 - 60x120 . 24"x48"
Ret - SATIN 3D PM - 51,50

199522 - 60x120 . 24"x48"
Ret - Bocciardato SOFT GRIP PM - 51,50



199542 - 60x120 . 24"x48"
Ret - Bambus SATIN 3D PM - 63,00



199492 - 60x60 . 24"x24"
Ret - SATIN 3D PM - 40,50



199502 30x60 . 12"x24"
Ret - SATIN 3D PM - 40,50



199562 - 20x60 . 8"x24"
Pavé Wall Muretto - ROWS 10mm PM - 50,00

NAVONA 20MM



BIANCO



199621 - 60x120 . 24"x48" Ret - Bocciardato GRIP PM - 77,50

BEIGE



199622 - 60x120 . 24"x48" Ret - Bocciardato GRIP PM - 77,50



SVILUPPO GRAFICO / PATTERNS

- 60x120 **10** Facce differenti / Different Patterns
- 60x60 **20** Facce differenti / Different Patterns
- 30x60 **40** Facce differenti / Different Patterns
- 20x60 **60** Facce differenti / Different Patterns

165

PEZZI SPECIALI 9MM . SPECIAL PIECES . PIÈCES SPÉCIALES . SPEZIALTEILE



PL - 13,50
Battiscopa
6x60 . 2"x24" Ret - SATIN
199571 - Bianco
199572 - Beige

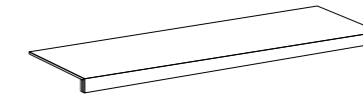

PP - 250,00
Gradino Costa Retta
33x120 . 13"x48" Ret - SATIN 3D
199581 - Bianco
199582 - Beige

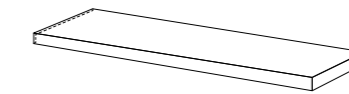

PP - 300,00
Angolo Gradino Costa Retta DX
33x120 . 13"x48" Ret - SATIN 3D
199591 - Bianco
199592 - Beige

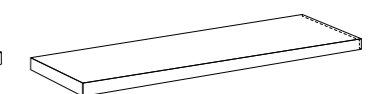

PP - 300,00
Angolo Gradino Costa Retta SX
33x120 . 13"x48" Ret - SATIN 3D
199601 - Bianco
199602 - Beige

PEZZI SPECIALI 20MM . SPECIAL PIECES . PIÈCES SPÉCIALES . SPEZIALTEILE

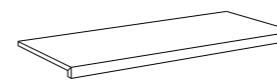

PP - 302,00
Gradino Costa Retta
33x120 . 13"x48" Ret - Bocciardato GRIP
199651 - Bianco
199652 - Beige

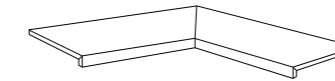

PP - 757,00
Angolo Int. Gradino Costa Retta
33x120 . 13"x48" Ret - Bocciardato GRIP
199661 - Bianco
199662 - Beige



PP - 168,00
Angolo Est. Gradino Costa Retta
33x33 . 13"x13" Ret - Bocciardato GRIP
199671 - Bianco
199672 - Beige



PORT LAURENT CALACATTA GOLD DOLOMITE PALISSANDRO ARABESQUE ONIX TRAVERTINE

PRESTIGE

Prestige interpreta la bellezza del marmo attraverso texture 3D e disegni naturali e geometrici, offrendo superfici eleganti e versatili per ogni progetto.

Prestige interprets the beauty of marble through 3D textures and natural or geometric patterns, offering elegant and versatile surfaces for every design project.

Prestige interprète la beauté du marbre à travers des textures 3D et des motifs naturels ou géométriques, offrant des surfaces élégantes et polyvalentes pour tout projet de design.

Prestige interpretiert die Schönheit des Marmors mit 3D-Strukturen und natürlichen oder geometrischen Mustern und bietet elegante, vielseitige Oberflächen für jedes Gestaltungskonzept.



PRESTIGE

PORT LAURENT



198373 - 60x120 . 24"x48" PM - 56,70

Ret - SATIN 3D

198383 - 60x120 . 24"x48" PM - 70,00

Ret - LAPPATO



198393 - 60x60 . 24"x24" PM - 46,70

Ret - SATIN 3D



198453 - 60x120 . 24"x48" PM - 75,00

Magic Port & Arabesque Ret - SATIN 3D



199093 30x60 . 12"x24" PM - 46,70

Ret - SATIN 3D



198410 - 60x120 . 24"x48" PM - 75,00

Bits & Pieces Port & Gold Ret - SATIN 3D



199083 - 30x30 . 12"x12" PM - 45,00

Ret - SATIN 3D



198493 - 7,2x30 . 3"x12" PM - 77,00

Ret - SATIN 3D



198503 - 7,2x7,2 . 3"x3" PM - 125,00

Ret - SATIN 3D



198456 - 60x120 . 24"x48" PM - 75,00

Magic Port & Travertine Ret - SATIN 3D



CALACATTA GOLD



198372 - 60x120 . 24"x48" PM - 56,70

Ret - SATIN 3D

198382 - 60x120 . 24"x48" PM - 70,00

Ret - LAPPATO



198392 - 60x60 . 24"x24" PM - 46,70

Ret - SATIN 3D

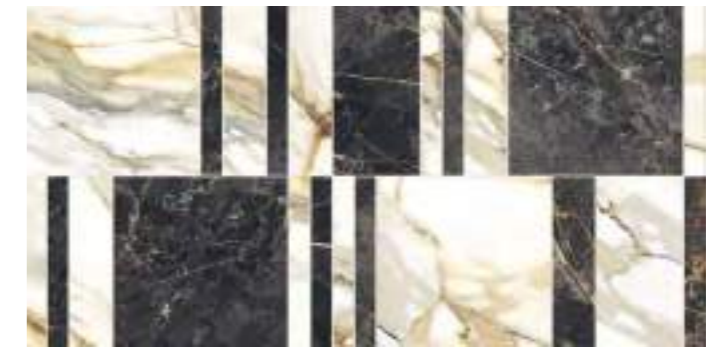

198410 - 60x120 . 24"x48" PM - 75,00

Bits & Pieces Port & Gold Ret - SATIN 3D



199092 30x60 . 12"x24" PM - 46,70

Ret - SATIN 3D



199082 - 30x30 . 12"x12" PM - 45,00

Ret - SATIN 3D



198492 - 7,2x30 . 3"x12" PM - 77,00

Ret - SATIN 3D



198502 - 7,2x7,2 . 3"x3" PM - 125,00

Ret - SATIN 3D



SVILUPPO GRAFICO / PATTERNS

Port Laurent

- 60x120 **12** Facce differenti / Different Patterns
- 60x60 **24** Facce differenti / Different Patterns
- 30x60 **48** Facce differenti / Different Patterns
- 30x30 **96** Facce differenti / Different Patterns
- 7,2x30 **384** Facce differenti / Different Patterns
- 7,2x7,2 **1536** Facce differenti / Different Patterns
- 60x120 Bits&Pieces **9** Facce differenti / Different Patterns
- 60x120 Magic **5** Facce differenti / Different Patterns

SVILUPPO GRAFICO / PATTERNS

Calacatta Gold

- 60x120 **15** Facce differenti / Different Patterns
- 60x60 **30** Facce differenti / Different Patterns
- 30x60 **60** Facce differenti / Different Patterns
- 30x30 **120** Facce differenti / Different Patterns
- 7,2x30 **480** Facce differenti / Different Patterns
- 7,2x7,2 **1920** Facce differenti / Different Patterns
- 60x120 Bits&Pieces **9** Facce differenti / Different Patterns

PRESTIGE



DOLOMITE



198375 - 60x120 . 24"x48"
Ret - SATIN 3D PM - 56,70

198385 - 60x120 . 24"x48"
Ret - LAPPATO PM - 70,00



198395 - 60x60 . 24"x24"
Ret - SATIN 3D PM - 46,70



198430 - 60x120 . 24"x48"
Hoop Dolomite & Palissandro Ret - SATIN 3D PM - 75,00



199095 30x60 . 12"x24"
Ret - SATIN 3D PM - 46,70



199085 - 30x30 . 12"x12"
Ret - SATIN 3D PM - 45,00



198495 - 7,2x30 . 3"x12"
Ret - SATIN 3D PM - 77,00



198505 - 7,2x7,2 . 3"x3"
Ret - SATIN 3D PM - 125,00



SVILUPPO GRAFICO / PATTERNS

Dolomite

- 60x120
- 60x60
- 30x60
- 30x30
- 7,2x30
- 7,2x7,2
- 60x120 Hoop

- 12 Facce differenti / Different Patterns
- 24 Facce differenti / Different Patterns
- 48 Facce differenti / Different Patterns
- 96 Facce differenti / Different Patterns
- 384 Facce differenti / Different Patterns
- 1536 Facce differenti / Different Patterns
- 5 Facce differenti / Different Patterns

PALISSANDRO



198376 - 60x120 . 24"x48"
Ret - SATIN 3D PM - 56,70

198386 - 60x120 . 24"x48"
Ret - LAPPATO PM - 70,00



198396 - 60x60 . 24"x24"
Ret - SATIN 3D PM - 46,70



198430 - 60x120 . 24"x48"
Hoop Dolomite & Palissandro Ret - SATIN 3D PM - 75,00



199096 30x60 . 12"x24"
Ret - SATIN 3D PM - 46,70



199086 - 30x30 . 12"x12"
Ret - SATIN 3D PM - 45,00



198496 - 7,2x30 . 3"x12"
Ret - SATIN 3D PM - 77,00



198506 - 7,2x7,2 . 3"x3"
Ret - SATIN 3D PM - 125,00



SVILUPPO GRAFICO / PATTERNS

Palissandro

- 60x120
- 60x60
- 30x60
- 30x30
- 7,2x30
- 7,2x7,2
- 60x120 Hoop

- 12 Facce differenti / Different Patterns
- 24 Facce differenti / Different Patterns
- 48 Facce differenti / Different Patterns
- 96 Facce differenti / Different Patterns
- 384 Facce differenti / Different Patterns
- 1536 Facce differenti / Different Patterns
- 5 Facce differenti / Different Patterns

PRESTIGE

ARABESQUE



198371 - 60x120 . 24"x48" PM - 56,70
Ret - SATIN 3D

198381 - 60x120 . 24"x48" PM - 70,00
Ret - LAPPATO



198391 - 60x60 . 24"x24" PM - 46,70
Ret - SATIN 3D

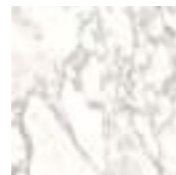

199081 - 30x30 . 12"x12" PM - 45,00
Ret - SATIN 3D



198491 - 7,2x30 . 3"x12" PM - 77,00
Ret - SATIN 3D



198501 - 7,2x7,2 . 3"x3" PM - 125,00
Ret - SATIN 3D



198453 - 60x120 . 24"x48" PM - 75,00
Magic Port & Arabesque Ret - SATIN 3D

V3 **SVILUPPO GRAFICO / PATTERNS**
Arabesque
60x120 **10** Facce differenti / Different Patterns
60x60 **20** Facce differenti / Different Patterns
30x30 **80** Facce differenti / Different Patterns
7,2x30 **320** Facce differenti / Different Patterns
7,2x7,2 **1280** Facce differenti / Different Patterns
60x120 Magic **5** Facce differenti / Different Patterns

ONIX



198374 - 60x120 . 24"x48" PM - 56,70
Ret - SATIN 3D

198384 - 60x120 . 24"x48" PM - 70,00
Ret - LAPPATO



198394 - 60x60 . 24"x24" PM - 46,70
Ret - SATIN 3D

V2 **SVILUPPO GRAFICO / PATTERNS**
Onix
60x120 **12** Facce differenti / Different Patterns
60x60 **24** Facce differenti / Different Patterns



TRAVERTINE



198377 - 60x120 . 24"x48" PM - 56,70
Ret - SATIN 3D

198387 - 60x120 . 24"x48" PM - 70,00
Ret - LAPPATO

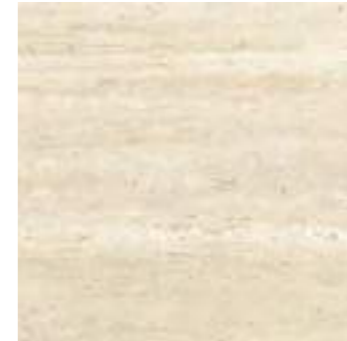

198397 - 60x60 . 24"x24" PM - 46,70
Ret - SATIN 3D



198456 - 60x120 . 24"x48" PM - 75,00
Magic Port & Travertine Ret - SATIN 3D



199087 - 30x30 . 12"x12" PM - 45,00
Ret - SATIN 3D



198497 - 7,2x30 . 3"x12" PM - 77,00
Ret - SATIN 3D



198507 - 7,2x7,2 . 3"x3" PM - 125,00
Ret - SATIN 3D

V2 **SVILUPPO GRAFICO / PATTERNS**
Travertine
60x120 **12** Facce differenti / Different Patterns
60x60 **24** Facce differenti / Different Patterns
30x30 **96** Facce differenti / Different Patterns
7,2x30 **384** Facce differenti / Different Patterns
7,2x7,2 **1536** Facce differenti / Different Patterns
60x120 Magic **5** Facce differenti / Different Patterns

ATTENZIONE . BE CAREFUL . ATTENTION . ACHTUNG
Superficie Lappato - Utilizzare stucchi cementizi con colori tono su tono.
Lappato surface - Use cement-based grout with tone on tone colours.
Surface Lappato - Utiliser des mortiers-joints avec des couleurs ton sur ton.
Lappato Oberfläche - Sollten Zementkittre in ähnlichen Farbtönen verwendet werden.

PEZZI SPECIALI 9MM . SPECIAL PIECES . PIÈCES SPÉCIALES . SPEZIALTEILE



PL - 13,50

Battiscopa
6x60 . 2"x24" Ret - SATIN 3D
198512 - Calacatta Gold
198513 - Port Laurent
198515 - Dolomite
198516 - Palissandro
198511 - Arabesque
198514 - Onix
198517 - Travertine

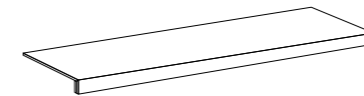

PP - 250,00

Gradino Costa Retta
33x120 . 13"x48" Ret - SATIN 3D
198522 - Calacatta Gold
198523 - Port Laurent
198525 - Dolomite
198526 - Palissandro
198521 - Arabesque
198524 - Onix
198527 - Travertine

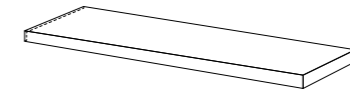

PP - 300,00

Angolo Gradino Costa Retta DX
33x120 . 13"x48" Ret - SATIN 3D
198532 - Calacatta Gold
198533 - Port Laurent
198535 - Dolomite
198536 - Palissandro
198531 - Arabesque
198534 - Onix
198537 - Travertine

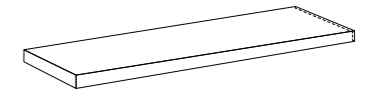

PP - 300,00

Angolo Gradino Costa Retta SX
33x120 . 13"x48" Ret - SATIN 3D
198542 - Calacatta Gold
198543 - Port Laurent
198545 - Dolomite
198546 - Palissandro
198541 - Arabesque
198544 - Onix
198547 - Travertine



CREAM BROWN GREY BLUE

COPICO

Copico celebra colore, design e matericità con superfici in gres porcellanato ispirate al ceppo di Gré: cremosi, beige, grigi e blu, per rivestimenti interni versatili e armoniosi.

Copico highlights colour, design and material depth through porcelain stoneware inspired by ceppo di Gré, offering warm creams, beiges, greys and blues for balanced, versatile interior spaces.

Copico met en valeur la couleur, le design et la matière avec un grès cérame inspiré du ceppo di Gré, décliné en tons crème, beige, gris et bleu pour des intérieurs harmonieux et polyvalents.

Copico verbindet Farbe, Design und Materialität in einem vom Ceppo di Gré inspirierten Feinsteinzeug und bietet warme Creme-, Beige-, Grau- und Blautöne für vielseitige, stimmige Innenräume.



COPICO



CREAM



194771 - 60x120 . 24"x48" Ret - MATT PM - 56,70



195251 - 60x60 . 24"x24" Ret - MATT PM - 46,70

BROWN



194773 - 60x120 . 24"x48" Ret - MATT PM - 56,70

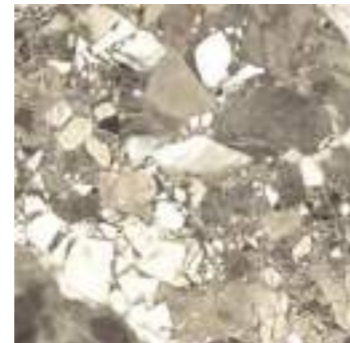

195253 - 60x60 . 24"x24" Ret - MATT PM - 46,70

BLUE



194774 - 60x120 . 24"x48" Ret - MATT PM - 56,70



195254 - 60x60 . 24"x24" Ret - MATT PM - 46,70

GREY



194772 - 60x120 . 24"x48" Ret - MATT PM - 56,70



195252 - 60x60 . 24"x24" Ret - MATT PM - 46,70

PEZZI SPECIALI 9MM . SPECIAL PIECES . PIÈCES SPÉCIALES . SPEZIALTEILE

infotech p. 280



PL - 13,50

Battiscopa
7x60 . 2,5x24" Ret - MATT

- 194951 - Cream
- 194953 - Brown
- 194952 - Grey
- 194954 - Blue

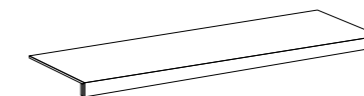

PP - 250,00

Gradino Costa Retta
33x120 . 13"x48" Ret - MATT

- 194921 - Cream
- 194923 - Brown
- 194922 - Grey
- 194924 - Blue

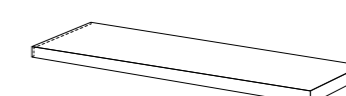

PP - 300,00

Angolo Gradino Costa Retta DX
33x120 . 13"x48" Ret - MATT

- 194931 - Cream
- 194933 - Brown
- 194932 - Grey
- 194934 - Blue

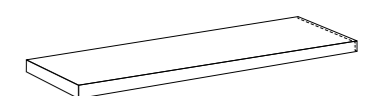

PP - 300,00

Angolo Gradino Costa Retta SX
33x120 . 13"x48" Ret - MATT

- 194941 - Cream
- 194943 - Brown
- 194942 - Grey
- 194944 - Blue

V2

SVILUPPO GRAFICO / PATTERNS

- 60x120 **8** Facce differenti / Different Patterns
- 60x60 **16** Facce differenti / Different Patterns



CONTEMPORARY CONTEMPORANEO

179

CON_CRET3	180
94_EVO	190
PROGETTO S7	200
ART BY SICHENIA Industrial	204
ME_TAL	210
BLOCK	214
PAVÉ BRICK	222



BIANCO BEIGE CAPPUCCINO GRIGIO CENERE GRIGIO BASALTO ANTRACITE

CON_CRETE

Con_cretè di Sichenia è una proposta materica effetto cemento, con texture profonde e nuance morbide e pastose che esaltano la resa contemporanea della superficie.

Con_cretè by Sichenia is a material-focused cement-effect collection, with deep textures and soft, velvety tones that enhance the contemporary character of the surface.

Con_cretè de Sichenia est une collection effet ciment à forte personnalité matérielle, avec des textures profondes et des nuances douces et veloutées qui valorisent le caractère contemporain de la surface.

Con_cretè von Sichenia ist eine materielle Cement-Effekt-Kollektion mit tiefen Strukturen und weichen, samtigen Farbtönen, die den zeitgenössischen Ausdruck der Oberfläche unterstreichen.

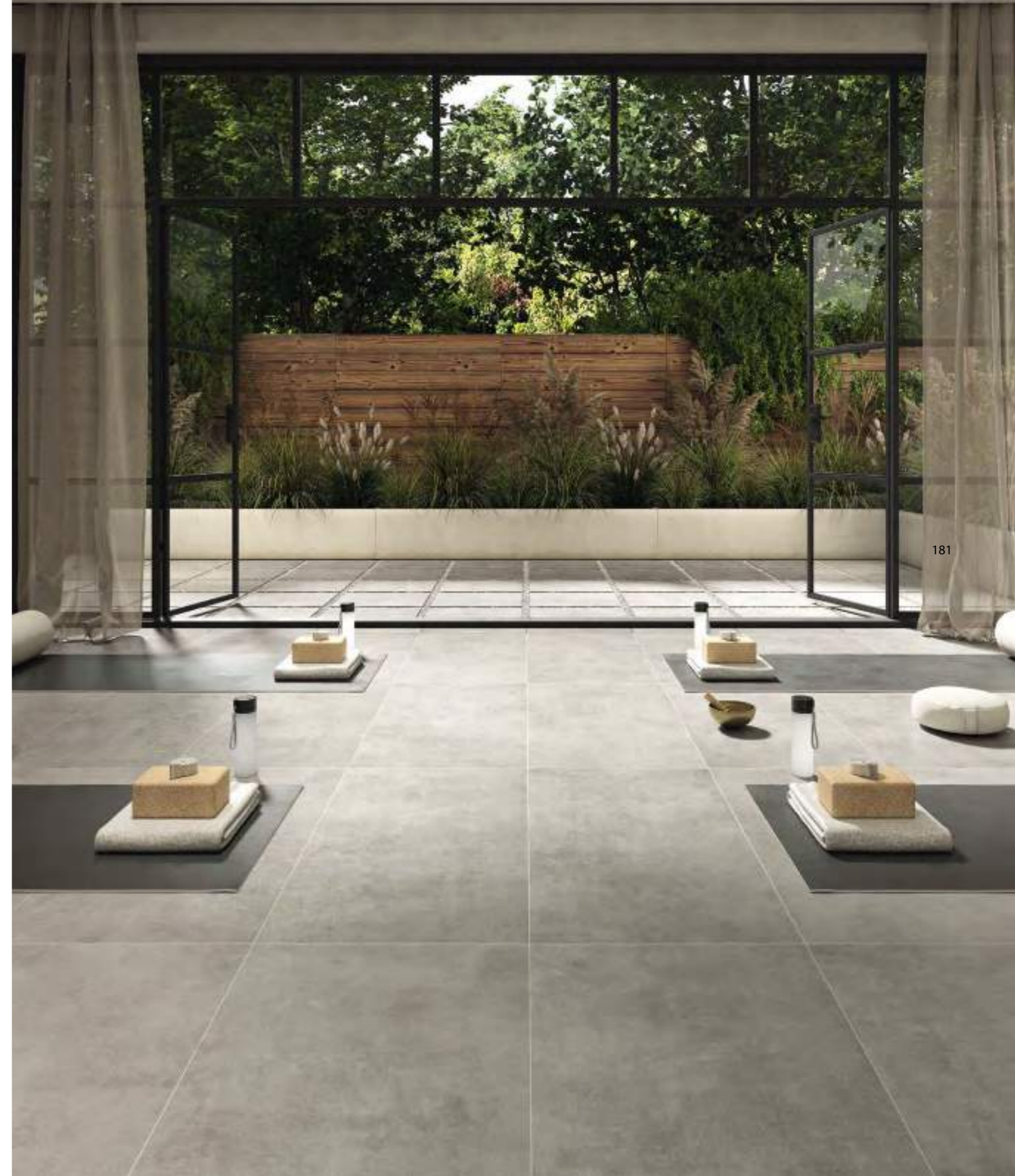

CON_CRET3



BIANCO



196981 - 120x120 . 48"x48" Ret - SATIN PM - 80,00



196311 - 60x120 . 24"x48" Ret - SOFT GRIP PM - 48,50
196321 - 60x120 . 24"x48" Ret - SATIN PM - 45,50
196331 - 60x120 . 24"x48" Ret - GRIP PM - 51,50

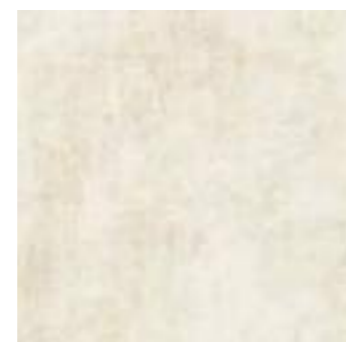

196351 - 60x60 . 24"x24" Ret - SOFT GRIP PM - 39,90
196361 - 60x60 . 24"x24" Ret - SATIN PM - 36,70
197081 - 60x60 . 24"x24" Ret - GRIP PM - 41,50



196371 - 30x60 . 12"x24" Ret - SOFT GRIP PM - 39,90
197811 - 30x60 . 12"x24" Ret - GRIP PM - 41,50



196271 - 90x90 . 36"x36" Ret - SATIN PM - 46,90
197101 - 90x90 . 36"x36" Ret - SOFT GRIP PM - 49,00

BEIGE



196272 - 90x90 . 36"x36" Ret - SATIN PM - 46,90



196312 - 60x120 . 24"x48" Ret - SOFT GRIP PM - 48,50
196322 - 60x120 . 24"x48" Ret - SATIN PM - 45,50
196332 - 60x120 . 24"x48" Ret - GRIP PM - 51,50



196352 - 60x60 . 24"x24" Ret - SOFT GRIP PM - 39,90
196362 - 60x60 . 24"x24" Ret - SATIN PM - 36,70
197082 - 60x60 . 24"x24" Ret - GRIP PM - 41,50



196372 - 30x60 . 12"x24" Ret - SOFT GRIP PM - 39,90
197812 - 30x60 . 12"x24" Ret - GRIP PM - 41,50

PEZZI SPECIALI 9MM . SPECIAL PIECES . PIÈCES SPÉCIALES . SPEZIALTEILE

infotech p. 280



Gradino Becco di Civetta con Righe
 30x60 . 12"x24" Ret - SOFT GRIP PL - 68,00
196401 - Bianco
196402 - Beige



Battiscopa
 6x60 . 2"x24" Ret - SATIN PL - 13,50
196491 - Bianco
196492 - Beige

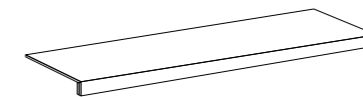

Gradino Costa Retta
 33x120 . 13"x48" Ret - SATIN PP - 250,00
196411 - Bianco
196412 - Beige

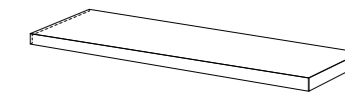

Angolo Gradino Costa Retta Dx
 33x120 . 13"x48" Ret - SATIN PP - 300,00
196421 - Bianco
196422 - Beige

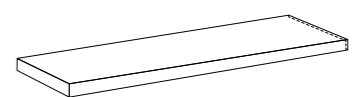

Angolo Gradino Costa Retta Sx
 33x120 . 13"x48" Ret - SATIN PP - 300,00
196431 - Bianco
196432 - Beige

V2 SVILUPPO GRAFICO / PATTERNS

- 120x120 **5** Facce differenti / Different Patterns
- 90x90 **10** Facce differenti / Different Patterns
- 60x120 **10** Facce differenti / Different Patterns
- 60x60 **20** Facce differenti / Different Patterns
- 30x60 **40** Facce differenti / Different Patterns

CON_CRET3

CAPPUCCINO



196983 - 120x120 . 48"x48" Ret - SATIN PM - 80,00



196313 - 60x120 . 24"x48" Ret - SOFT GRIP PM - 48,50
196323 - 60x120 . 24"x48" Ret - SATIN PM - 45,50
196333 - 60x120 . 24"x48" Ret - GRIP PM - 51,50



196353 - 60x60 . 24"x24" Ret - SOFT GRIP PM - 39,90
196363 - 60x60 . 24"x24" Ret - SATIN PM - 36,70
197083 - 60x60 . 24"x24" Ret - GRIP PM - 41,50

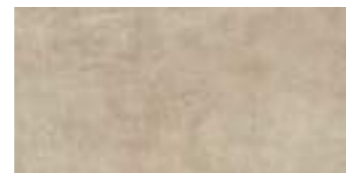

196373 - 30x60 . 12"x24" Ret - SOFT GRIP PM - 39,90
197813 - 30x60 . 12"x24" Ret - GRIP PM - 41,50



196273 - 90x90 . 36"x36" Ret - SATIN PM - 46,90
197103 - 90x90 . 36"x36" Ret - SOFT GRIP PM - 49,00



GRIGIO CENERE



196274 - 90x90 . 36"x36" Ret - SATIN PM - 46,90
197104 - 90x90 . 36"x36" Ret - SOFT GRIP PM - 49,00



196314 - 60x120 . 24"x48" Ret - SOFT GRIP PM - 48,50
196324 - 60x120 . 24"x48" Ret - SATIN PM - 45,50



196354 - 60x60 . 24"x24" Ret - SOFT GRIP PM - 39,90
196364 - 60x60 . 24"x24" Ret - SATIN PM - 36,70
197084 - 60x60 . 24"x24" Ret - GRIP PM - 41,50



196374 - 30x60 . 12"x24" Ret - SOFT GRIP PM - 39,90

PEZZI SPECIALI 9MM . SPECIAL PIECES . PIÈCES SPÉCIALES . SPEZIALTEILE

infotech p. 280

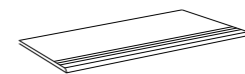

Gradino Becco di Civetta con Righe
 30x60 . 12"x24" Ret - SOFT GRIP PL - 68,00
196403 - Cappuccino
196404 - Grigio Cenere



Battiscopa
 6x60 . 2"x24" Ret - SATIN PL - 13,50
196493 - Cappuccino
196494 - Grigio Cenere

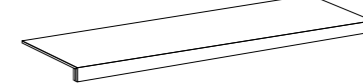

Gradino Costa Retta
 33x120 . 13"x48" Ret - SATIN PP - 250,00
196413 - Cappuccino
196414 - Grigio Cenere



Angolo Gradino Costa Retta Dx
 33x120 . 13"x48" Ret - SATIN PP - 300,00
196423 - Cappuccino
196424 - Grigio Cenere

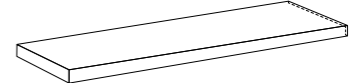

Angolo Gradino Costa Retta Sx
 33x120 . 13"x48" Ret - SATIN PP - 300,00
196433 - Cappuccino
196434 - Grigio Cenere

V2 SVILUPPO GRAFICO / PATTERNS

- 120x120 **5** Facce differenti / Different Patterns
- 90x90 **10** Facce differenti / Different Patterns
- 60x120 **10** Facce differenti / Different Patterns
- 60x60 **20** Facce differenti / Different Patterns
- 30x60 **40** Facce differenti / Different Patterns

CON_CRET3

GRIGIO BASALTO



196985 - 120x120 . 48"x48" Ret - SATIN PM - 80,00



196315 - 60x120 . 24"x48" Ret - SOFT GRIP PM - 48,50
196325 - 60x120 . 24"x48" Ret - SATIN PM - 45,50
196335 - 60x120 . 24"x48" Ret - GRIP PM - 51,50



196355 - 60x60 . 24"x24" Ret - SOFT GRIP PM - 39,90
196365 - 60x60 . 24"x24" Ret - SATIN PM - 36,70
197085 - 60x60 . 24"x24" Ret - GRIP PM - 41,50



196375 - 30x60 . 12"x24" Ret - SOFT GRIP PM - 39,90
197815 - 30x60 . 12"x24" Ret - GRIP PM - 41,50



196275 - 90x90 . 36"x36" Ret - SATIN PM - 46,90
197105 - 90x90 . 36"x36" Ret - SOFT GRIP PM - 49,00

186



ANTRACITE



196276 - 90x90 . 36"x36" Ret - SATIN PM - 46,90



196316 - 60x120 . 24"x48" Ret - SOFT GRIP PM - 48,50
196326 - 60x120 . 24"x48" Ret - SATIN PM - 45,50



196356 - 60x60 . 24"x24" Ret - SOFT GRIP PM - 39,90
196366 - 60x60 . 24"x24" Ret - SATIN PM - 36,70
197086 - 60x60 . 24"x24" Ret - GRIP PM - 41,50



196376 - 30x60 . 12"x24" Ret - SOFT GRIP PM - 39,90

187

PEZZI SPECIALI 9MM . SPECIAL PIECES . PIÈCES SPÉCIALES . SPEZIALTEILE

infotech p. 280

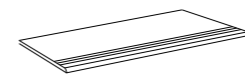

Gradino Becco di Civetta con Righe
 30x60 . 12"x24" Ret - SOFT GRIP PL - 68,00
196405 - Grigio Basalto
196406 - Antracite



Battiscopa
 6x60 . 2"x24" Ret - SATIN PL - 13,50
196495 - Grigio Basalto
196496 - Antracite

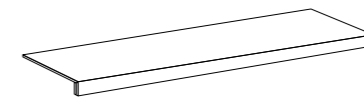

Gradino Costa Retta
 33x120 . 13"x48" Ret - SATIN PP - 250,00
196415 - Grigio Basalto
196416 - Antracite

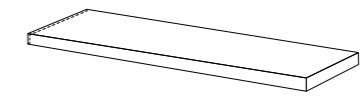

Angolo Gradino Costa Retta Dx
 33x120 . 13"x48" Ret - SATIN PP - 300,00
196425 - Grigio Basalto
196426 - Antracite

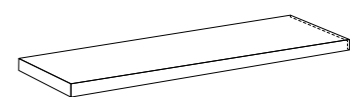

Angolo Gradino Costa Retta Sx
 33x120 . 13"x48" Ret - SATIN PP - 300,00
196435 - Grigio Basalto
196436 - Antracite

V2 SVILUPPO GRAFICO / PATTERNS

- | | | |
|---------|----|---------------------------------------|
| 120x120 | 5 | Facce differenti / Different Patterns |
| 90x90 | 10 | Facce differenti / Different Patterns |
| 60x120 | 10 | Facce differenti / Different Patterns |
| 60x60 | 20 | Facce differenti / Different Patterns |
| 30x60 | 40 | Facce differenti / Different Patterns |

CON_CRET3 20MM



BIANCO



60x60 . 24"x24" Ret - GRIP
196391 - Bianco PM - 66,00

60x120 . 24"x48" Ret - GRIP
196991 - Bianco PM - 77,50

90x90 . 36"x36" Ret - GRIP
197021 - Bianco PM - 77,50

BEIGE



60x60 . 24"x24" Ret - GRIP
196392 - Beige PM - 66,00

CAPPUCCINO



60x60 . 24"x24" Ret - GRIP
196393 - Cappuccino PM - 66,00

60x120 . 24"x48" Ret - GRIP
196993 - Cappuccino PM - 77,50

90x90 . 36"x36" Ret - GRIP
197023 - Cappuccino PM - 77,50

GRIGIO CENERE



60x60 . 24"x24" Ret - GRIP
196394 - Grigio Cenere PM - 66,00

90x90 . 36"x36" Ret - GRIP
197024 - Grigio Cenere PM - 77,50

GRIGIO BASALTO



60x60 . 24"x24" Ret - GRIP
196395 - Grigio Basalto PM - 66,00

60x120 . 24"x48" Ret - GRIP
196995 - Grigio Basalto PM - 77,50

90x90 . 36"x36" Ret - GRIP
197025 - Grigio Basalto PM - 77,50

PEZZI SPECIALI 20MM . SPECIAL PIECES . PIÈCES SPÉCIALES . SPEZIALTEILE

inotech p. 280

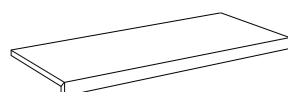

PP - 155,00

Gradino Costa Retta
33x60 . 13"x24" Ret - GRIP
196441 - Bianco
196442 - Beige
196443 - Cappuccino
196444 - Grigio Cenere
196445 - Grigio Basalto

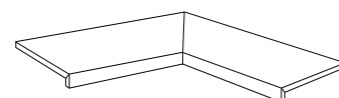

PP - 385,00

Angolo Int. Gradino Costa Retta
33x60 . 13"x24" Ret - GRIP
196451 - Bianco
196452 - Beige
196453 - Cappuccino
196454 - Grigio Cenere
196455 - Grigio Basalto



PP - 164,00

Angolo Est. Gradino Costa Retta
33x33 . 13"x13" Ret - GRIP
196461 - Bianco
196462 - Beige
196463 - Cappuccino
196464 - Grigio Cenere
196465 - Grigio Basalto

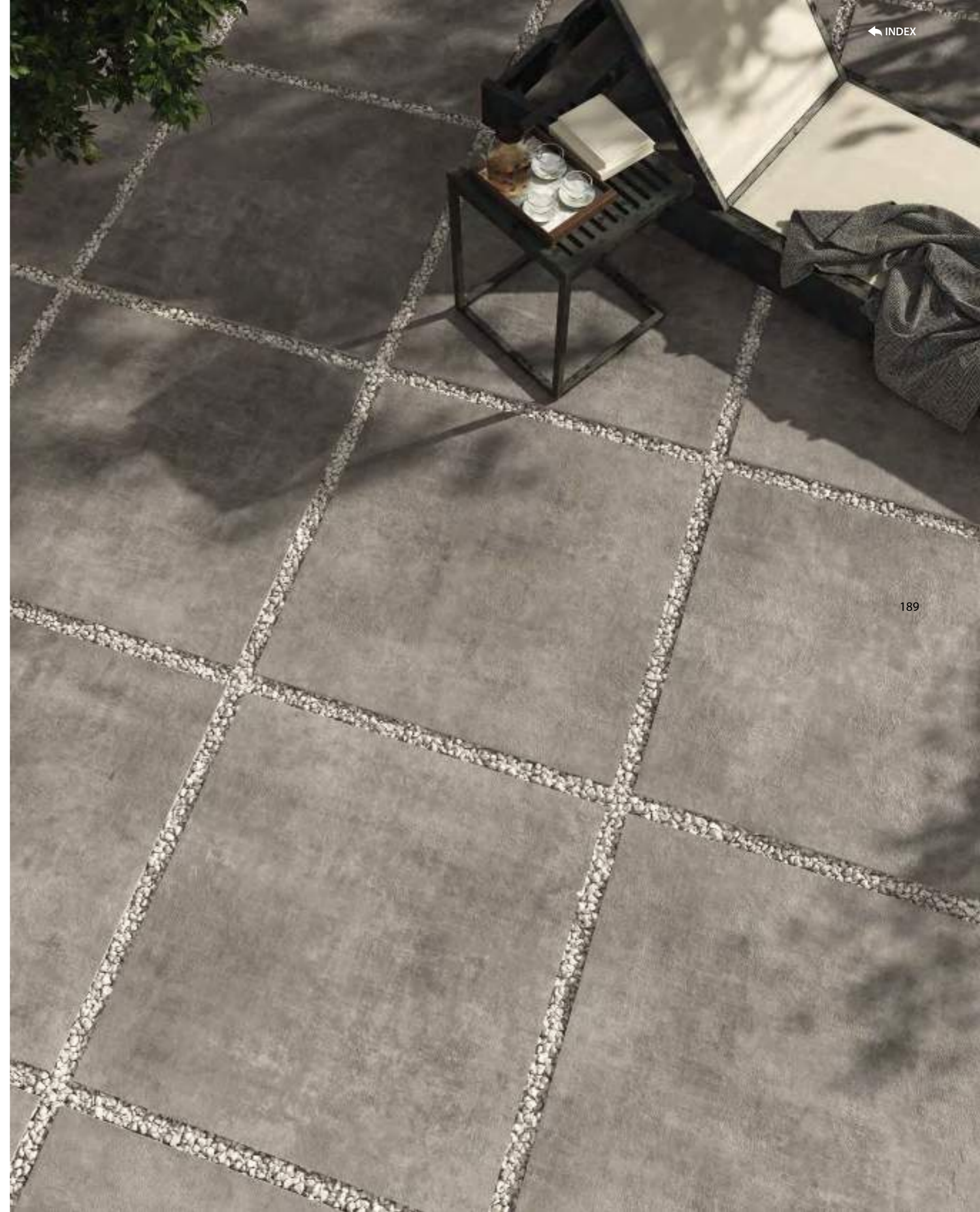

190



BIANCO DI SPAGNA TERRA DI VINCENZA GRIGIO CROMO MICA PERLATA NERO FUMO



TERRA D'UMBRIA OCRA DEL MOROCCO VERDE DI NICOSIA TERRA ARABICA BLU D'EGITTO

94_EVO

94_EVO esplora l'anima della terra con un gres porcellanato effetto cemento ricco di colore: 10 tonalità vibranti e una matericità studiata per dare vitalità e carattere a ogni progetto.

94_EVO explores the essence of earth with a cement-effect porcelain stoneware full of color: 10 vibrant shades and carefully designed textures bring energy and character to any project.

94_EVO explore l'âme de la terre avec un grès cérame effet ciment riche en couleur: 10 teintes vibrantes et des textures étudiées apportent vitalité et caractère à chaque projet.

94_EVO erkundet den Kern der Erde mit farbigem Cement-Effekt-Feinsteinzeug: 10 lebendige Farbtöne und durchdachte Strukturen verleihen jedem Projekt Energie und Charakter.



191

94_EVO

BIANCO DI SPAGNA



188751 - 90x90 . 36"x36" Ret - MATT PM - 50,00



188221 - 60x120 . 24"x48" Ret - MATT PM - 56,70

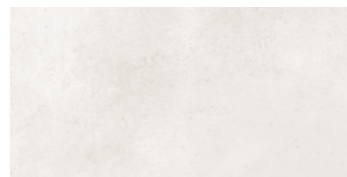

188581 - 30x60 . 12"x24" Ret - MATT PM - 39,90



188231 - 60x60 . 24"x24" Ret - MATT PM - 39,90



190071 - 30x30 . 12"x12" (5x5 . 2"x2")
Modulo rete Ret - MATT PP - 18,00



TERRA DI VICENZA



18875A - 90x90 . 36"x36" Ret - MATT PM - 50,00



18822A - 60x120 . 24"x48" Ret - MATT PM - 56,70

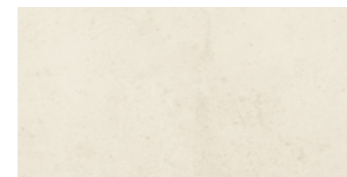

18858A - 30x60 . 12"x24" Ret - MATT PM - 39,90



18823A - 60x60 . 24"x24" Ret - MATT PM - 39,90



19007A - 30x30 . 12"x12" (5x5 . 2"x2")
Modulo rete Ret - MATT PP - 18,00

192

193

V2

SVILUPPO GRAFICO / PATTERNS

- | | |
|-----------------|---|
| 90x90 | 8 Facce differenti / Different Patterns |
| 60x120 | 12 Facce differenti / Different Patterns |
| 60x60 | 24 Facce differenti / Different Patterns |
| 30x60 | 48 Facce differenti / Different Patterns |
| 60x120 Chéri | 2 Facce differenti / Different Patterns |
| 60x120 Pigmenti | 4 Facce differenti / Different Patterns |
| 60x60 Pigmenti | 8 Facce differenti / Different Patterns |

PEZZI SPECIALI 9MM . SPECIAL PIECES . PIÈCES SPÉCIALES . SPEZIALTEILE

infotech p. 280



PL - 13,50
Battiscopa
7x60 . 2,5"x24" - Ret - MATT
188661 - Bianco di Spagna
18866A - Terra di Vicenza



PP - 250,00
Gradino Costa Retta
33x120 . 13"x48" Ret - MATT
188621 - Bianco di Spagna
18862A - Terra di Vicenza



PP - 300,00
Angolo Gradino Costa Retta Dx
33x120 . 13"x48" Ret - MATT
188631 - Bianco di Spagna
18863A - Terra di Vicenza



PP - 300,00
Angolo Gradino Costa Retta Sx
33x120 . 13"x48" Ret - MATT
188651 - Bianco di Spagna
18865A - Terra di Vicenza

94_EVO

GRIGIO CROMO



188752 - 90x90 . 36"x36" Ret - MATT PM - 50,00



188222 - 60x120 . 24"x48" Ret - MATT PM - 56,70



188582 - 30x60 . 12"x24" Ret - MATT PM - 39,90



188232 - 60x60 . 24"x24" Ret - MATT PM - 39,90

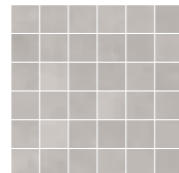

190072 - 30x30 . 12"x12" (5x5 . 2"x2") PP - 18,00
Modulo rete Ret - MATT



MICA PERLATA



188753 - 90x90 . 36"x36" Ret - MATT PM - 50,00



188223 - 60x120 . 24"x48" Ret - MATT PM - 56,70



188583 - 30x60 . 12"x24" Ret - MATT PM - 39,90



188233 - 60x60 . 24"x24" Ret - MATT PM - 39,90

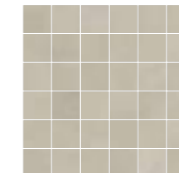

190073 - 30x30 . 12"x12" (5x5 . 2"x2") PP - 18,00
Modulo rete Ret - MATT

194

195

V2

SVILUPPO GRAFICO / PATTERNS

- | | | |
|-----------------|----|---------------------------------------|
| 90x90 | 8 | Facce differenti / Different Patterns |
| 60x120 | 12 | Facce differenti / Different Patterns |
| 60x60 | 24 | Facce differenti / Different Patterns |
| 30x60 | 48 | Facce differenti / Different Patterns |
| 60x120 Chéri | 2 | Facce differenti / Different Patterns |
| 60x120 Pigmenti | 4 | Facce differenti / Different Patterns |
| 60x60 Pigmenti | 8 | Facce differenti / Different Patterns |

PEZZI SPECIALI 9MM . SPECIAL PIECES . PIÈCES SPÉCIALES . SPEZIALTEILE

inotech p. 280



Battiscopa
7x60 . 2,5"x24" - Ret - MATT PL - 13,50
188662 - Grigio Cromo
188663 - Mica Perlata

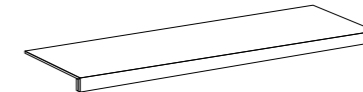

Gradino Costa Retta
33x120 . 13"x48" Ret - MATT PP - 250,00
188622 - Grigio Cromo
188623 - Mica Perlata

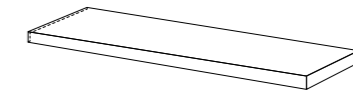

Angolo Gradino Costa Retta Dx
33x120 . 13"x48" Ret - MATT PP - 300,00
188632 - Grigio Cromo
188633 - Mica Perlata

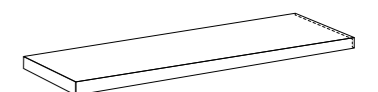

Angolo Gradino Costa Retta Sx
33x120 . 13"x48" Ret - MATT PP - 300,00
188652 - Grigio Cromo
188653 - Mica Perlata

94_EVO



NERO FUMO



188759 - 90x90 . 36"x36" Ret - MATT PM - 50,00



188229 - 60x120 . 24"x48" Ret - MATT PM - 56,70



188239 - 60x60 . 24"x24" Ret - MATT PM - 39,90



188589 - 30x60 . 12"x24" Ret - MATT PM - 39,90

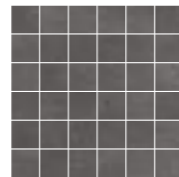

190079 - 30x30 . 12"x12" (5x5 . 2"x2") Modulo rete Ret - MATT PP - 18,00

196

197



PEZZI SPECIALI 9MM . SPECIAL PIECES . PIÈCES SPÉCIALES . SPEZIALTEILE

inotech p. 280



PL - 13,50

Battiscopa
7x60 . 2,5"x24" - Ret - MATT
188669 - Nero Fumo

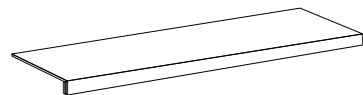

PP - 250,00

Gradino Costa Retta
33x120 . 13"x48" - Ret - MATT
188629 - Nero Fumo

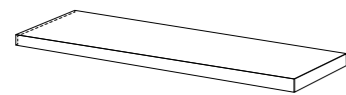

PP - 300,00

Angolo Gradino Costa Retta DX
33x120 . 13"x48" - Ret - MATT
188639 - Nero Fumo

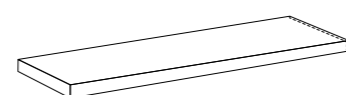

PP - 300,00

Angolo Gradino Costa Retta SX
33x120 . 13"x48" - Ret - MATT
188659 - Nero Fumo

94_EVO

TERRA D'UMBRIA



188224 - 60x120 . 24"x48" Ret - MATT

PM - 56,70



188234 - 60x60 . 24"x24" Ret - MATT

PM - 39,90



190074 - 30x30 . 12"x12"
(5x5 . 2"x2")
Modulo rete Ret - MATT

PP - 18,00

OCRA DEL MOROCCO



188225 - 60x120 . 24"x48" Ret - MATT

PM - 56,70



188235 - 60x60 . 24"x24" Ret - MATT

PM - 39,90

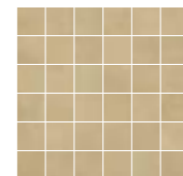

190075 - 30x30 . 12"x12"
(5x5 . 2"x2")
Modulo rete Ret - MATT

PP - 18,00

VERDE DI NICOSIA



188226 - 60x120 . 24"x48" Ret - MATT

PM - 56,70



188236 - 60x60 . 24"x24" Ret - MATT

PM - 39,90

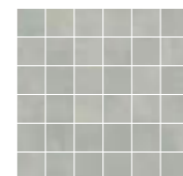

190076 - 30x30 . 12"x12"
(5x5 . 2"x2")
Modulo rete Ret - MATT

PP - 18,00

TERRA ARABICA

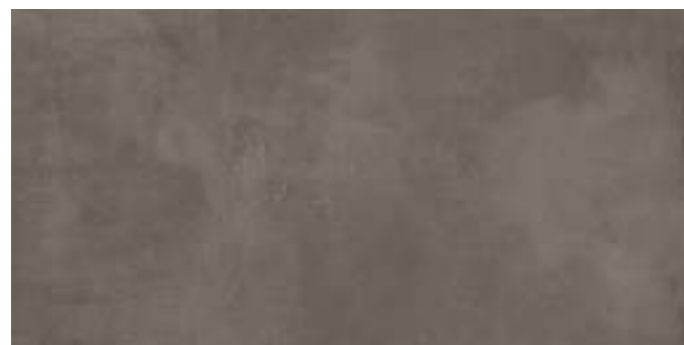

188227 - 60x120 . 24"x48" Ret - MATT

PM - 56,70

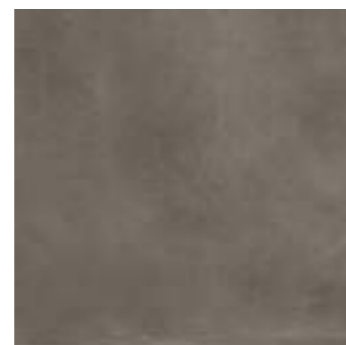

188237 - 60x60 . 24"x24" Ret - MATT

PM - 39,90

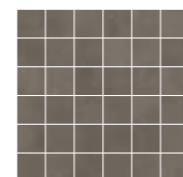

190077 - 30x30 . 12"x12"
(5x5 . 2"x2")
Modulo rete Ret - MATT

PP - 18,00



BLU D'EGITTO



188228 - 60x120 . 24"x48" Ret - MATT

PM - 56,70



188238 - 60x60 . 24"x24" Ret - MATT

PM - 39,90

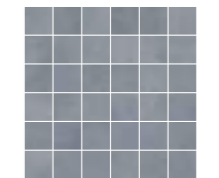

190078 - 30x30 . 12"x12"
(5x5 . 2"x2")
Modulo rete Ret - MATT

PP - 18,00

94_EVO DECORI



189652 - 60x120 . 24"x48" Chéri La Nuit Ret - MATT

PM - 63,00



188230 - 60x60 . 24"x24" Pigmenti Ret - MATT

PM - 50,00



189651 - 60x120 . 24"x48" Chéri Le Jour Ret - MATT

PM - 63,00



188220 - 60x120 . 24"x48" Pigmenti Ret - MATT

PM - 63,00

PEZZI SPECIALI 9MM . SPECIAL PIECES . PIÈCES SPÉCIALES . SPEZIALTEILE



p. 280



PL - 13,50

Battiscopa
7x60 . 2,5"x24" Ret - MATT
188664 - Terra d'Umbria
188665 - Ocra del Morocco
188666 - Verde di Nicosia
188667 - Terra Arabica
188668 - Blu d'Egitto

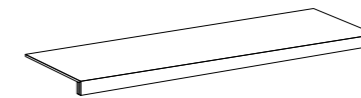

PP - 250,00

Gradino Costa Retta
33x120 . 13"x48" - Ret - MATT
188624 - Terra d'Umbria
188625 - Ocra del Morocco
188626 - Verde di Nicosia
188627 - Terra Arabica
188628 - Blu d'Egitto

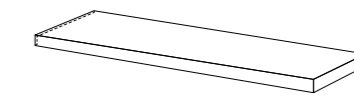

PP - 300,00

Angolo Gradino Costa Retta DX
33x120 . 13"x48" - Ret - MATT
188634 - Terra d'Umbria
188635 - Ocra del Morocco
188636 - Verde di Nicosia
188637 - Terra Arabica
188638 - Blu d'Egitto

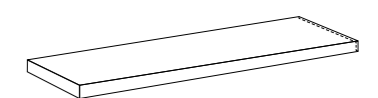

PP - 300,00

Angolo Gradino Costa Retta SX
33x120 . 13"x48" - Ret - MATT
188654 - Terra d'Umbria
188655 - Ocra del Morocco
188656 - Verde di Nicosia
188657 - Terra Arabica
188658 - Blu d'Egitto



BIANCO GRIGIO ROSA OCRA VERDE BLU NERO

PROGETTO S7

Progetto S7 combina artigianalità e design contemporaneo in brick colorati e di tendenza, disponibili in due formati, con finitura lucida e superficie ondulata che valorizza luce, profondità e movimento.

Progetto S7 blends craftsmanship and contemporary design in colorful, on-trend bricks, available in two sizes, with a glossy finish and undulating surface that enhances light, depth, and movement.

Progetto S7 allie savoir-faire et design contemporain avec des briques colorées et tendance, disponibles en deux formats, avec une finition brillante et une surface ondulée qui valorise la lumière, la profondeur et le mouvement.

Progetto S7 verbindet Handwerkskunst und zeitgenössisches Design in farbigen, trendigen Ziegeln, erhältlich in zwei Formaten, mit glänzender Oberfläche und welliger Struktur, die Licht, Tiefe und Bewegung betont.



PROGETTO S7



BIANCO

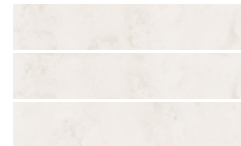

188891 - 8x41.3"x16"
GLOSSY
PM - 46,00



188901 - 16,5x41.6"x16"
Vaschetta GLOSSY
PM - 43,00

GRIGIO



188892 - 8x41.3"x16"
GLOSSY
PM - 46,00



188902 - 16,5x41.6"x16"
Vaschetta GLOSSY
PM - 43,00

ROSA



188894 - 8x41.3"x16"
GLOSSY
PM - 46,00



188904 - 16,5x41.6"x16"
Vaschetta GLOSSY
PM - 43,00

OCRA



188895 - 8x41.3"x16"
GLOSSY
PM - 46,00



188905 - 16,5x41.6"x16"
Vaschetta GLOSSY
PM - 43,00

VERDE



188896 - 8x41.3"x16"
GLOSSY
PM - 46,00



188906 - 16,5x41.6"x16"
Vaschetta GLOSSY
PM - 43,00

BLU



188898 - 8x41.3"x16"
GLOSSY
PM - 46,00



188908 - 16,5x41.6"x16"
Vaschetta GLOSSY
PM - 43,00

NERO

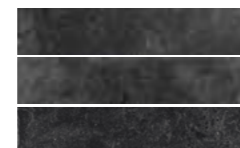

188899 - 8x41.3"x16"
GLOSSY
PM - 46,00



188909 - 16,5x41.6"x16"
Vaschetta GLOSSY
PM - 43,00

V3 SVILUPPO GRAFICO / PATTERNS
16,5x41 20 Facce differenti / Different Patterns
8x41 40 Facce differenti / Different Patterns

PEZZI SPECIALI 9MM . SPECIAL PIECES . PIÈCES SPÉCIALES . SPEZIALTEILE

infotech p. 280

PL - 14,00

Bullnose 8x41.3"x16" GLOSSY

- 193021 - Bianco
- 193022 - Grigio
- 193024 - Rosa
- 193025 - Ocra
- 193026 - Verde
- 193028 - Blu
- 193029 - Nero



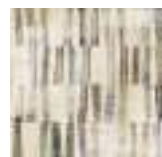

SESAME



HANAMI
WHITE



JULIETTE



SPRING



BAMBOO
BEIGE



CITY JUNGLE



ATOCHA
CAPPUCCINO

ART BY SICHENIA INDUSTRIAL

Art by Sichenia porta arte e colore nei tuoi spazi, con decori floreali e geometrici che trasformano le pareti in veri e propri quadri pieni di materia, luce e armonia.

Art by Sichenia brings art and color into your spaces, with floral and geometric decorations that turn walls into true works of art full of texture, light, and harmony.

Art by Sichenia apporte art et couleur à vos espaces, avec des décors floraux et géométriques qui transforment les murs en véritables œuvres d'art, pleines de matière, de lumière et d'harmonie.

Art by Sichenia bringt Kunst und Farbe in Ihre Räume, mit floralen und geometrischen Dekoren, die Wände in wahre Kunstwerke voller Struktur, Licht und Harmonie verwandeln.



ART BY SICHENIA INDUSTRIAL

GRES PORCELLANATO . PORCELAIN STONEWARE . GRÉS CÉRAME . FEINSTEINZEUG

HANAMI



193271 - 60x120 . 24"x48" Hanami White Ret - MATT **PM - 75,00**



193272 - 60x120 . 24"x48" Hanami Blu Ret - MATT **PM - 75,00**

V1 **SVILUPPO GRAFICO / PATTERNS**
60x120 Composizione a un pezzo / Single subject
Posa sia verticale che orizzontale / Both vertical and horizontal laying

ARTICOLI CON RIPRESA GRAFICA TRA LE DIVERSE LASTRE
CONTENUTA ENTRO UNA TOLLERANZA DI 3 MM.
ITEMS WITH GRAPHIC RESUMPTION BETWEEN THE DIFFERENT
SLABS CONTAINED WITHIN A TOLERANCE OF 3 MM.

SPRING



196511 - 60x120 . 24"x48" Ret - SATIN **PM - 75,00**

CITY JUNGLE



196531 - 60x120 . 24"x48" Ret - SATIN **PM - 75,00**

V3 **SVILUPPO GRAFICO / PATTERNS**
60x120 Composizione a un pezzo / Single subject
Solo posa verticale / Only vertical laying

ARTICOLI CON RIPRESA GRAFICA TRA LE DIVERSE LASTRE
CONTENUTA ENTRO UNA TOLLERANZA DI 3 MM.
ITEMS WITH GRAPHIC RESUMPTION BETWEEN THE DIFFERENT
SLABS CONTAINED WITHIN A TOLERANCE OF 3 MM.



JULIETTE A



196551D - 60x120 . 24"x48" Ret - MATT

JULIETTE B



PM - 63,00

V3 **SVILUPPO GRAFICO / PATTERNS**
60x120 Composizione a due pezzi / Two-piece composition
Solo posa verticale / Only vertical laying

COMPOSIZIONE 2 PEZZI - A e B sono inscatolati separatamente
(2pz collo). Vendita minima due composizioni.
COMPOSITION 2 PIECES - A e B are boxed separately
(2 pieces package). Minimum sale of two compositions.

ART BY SICHENIA INDUSTRIAL



BAMBOO A

BAMBOO B



196572D - 60x120 . 24"x48" Grigio Basalto Ret - SATIN PM - 75,00



196571D - 60x120 . 24"x48" Beige Ret - SATIN PM - 75,00

COMPOSIZIONE 2 PEZZI - A e B sono inscatolati separatamente (2pz collo). Vendita minima due composizioni.
COMPOSITION 2 PIECES - A e B are boxed separately (2 pieces package). Minimum sale of two compositions.

ARTICOLI CON RIPRESA GRAFICA TRA LE DIVERSE LASTRE CONTENUTA ENTRO UNA TOLLERANZA DI 3 MM.
ITEMS WITH GRAPHIC RESUMPTION BETWEEN THE DIFFERENT SLABS CONTAINED WITHIN A TOLERANCE OF 3 MM.

V3 SVILUPPO GRAFICO / PATTERNS
60x120 Composizione a due pezzi / Two-piece composition
Posa sia verticale che orizzontale / Both vertical and horizontal laying

SESAME



196611 - 60x120 . 24"x48" Ret - SATIN PM - 63,00

V2 SVILUPPO GRAFICO / PATTERNS
60x120 Composizione a un pezzo / Single subject
Posa verticale-orizzontale / Both vertical-horizontal laying



ATOCHA



196632 - 60x120 . 24"x48" Cappuccino Ret - SATIN PM - 78,00



196633 - 60x120 . 24"x48" Grigio Ret - SATIN PM - 78,00

ARTICOLI CON RIPRESA GRAFICA TRA LE DIVERSE LASTRE CONTENUTA ENTRO UNA TOLLERANZA DI 3 MM.
ITEMS WITH GRAPHIC RESUMPTION BETWEEN THE DIFFERENT SLABS CONTAINED WITHIN A TOLERANCE OF 3 MM.

V2 SVILUPPO GRAFICO / PATTERNS
60x120 Composizione a un pezzo / Single subject
Solo posa orizzontale / Only horizontal laying

210

211

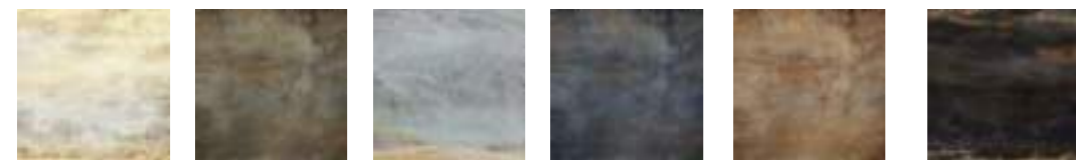

PEARL RUST SILVER DARK BLUE CORTEN BLACK

ME_TAL

Un progetto che cattura l'anima del metallo ossidato con colori intensi e sfumature policrome, creando superfici vive e di grande personalità grazie al gioco della luce.

A project that captures the essence of oxidized metal with intense colors and polychrome shades, creating vibrant surfaces full of character through the play of light.

Un projet qui capture l'âme du métal oxydé avec des couleurs intenses et des nuances polychromes, créant des surfaces vivantes et pleines de personnalité grâce au jeu de la lumière.

Ein Projekt, das die Essenz von oxidiertem Metall mit intensiven Farben und polychromen Schattierungen einfängt und durch das Spiel mit Licht lebendige, charakterstarke Oberflächen schafft.



ME_TAL



PEARL



184815 - 60x60 . 24"x24"
Ret - R10 PM - 63,00



183855 - 60x120 . 24"x48"
Ret - R10 PM - 65,50

CORTEN



184816 - 60x60 . 24"x24"
Ret - R10 PM - 63,00



183856 - 60x120 . 24"x48"
Ret - R10 PM - 65,50

SILVER



184811 - 60x60 . 24"x24"
Ret - R10 PM - 63,00



183851 - 60x120 . 24"x48"
Ret - R10 PM - 65,50

212

RUST

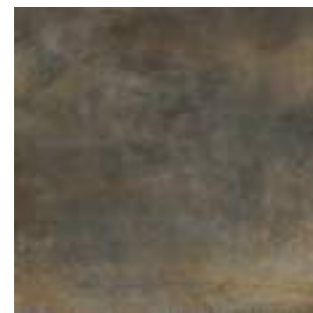

184813 - 60x60 . 24"x24"
Ret - R10 PM - 63,00



183853 - 60x120 . 24"x48"
Ret - R10 PM - 65,50

BLACK



184818 - 60x60 . 24"x24"
Ret - R10 PM - 63,00



183858 - 60x120 . 24"x48"
Ret - R10 PM - 65,50

213

DARK BLUE

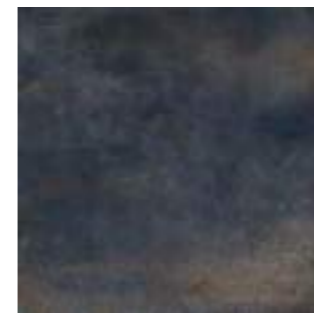

184817 - 60x60 . 24"x24"
Ret - R10 PM - 63,00



183857 - 60x120 . 24"x48"
Ret - R10 PM - 65,50

V4 **SVILUPPO GRAFICO / PATTERNS**
60x120 **10** Facce differenti / Different Patterns
60x60 **20** Facce differenti / Different Patterns

PEZZI SPECIALI 9MM . SPECIAL PIECES . PIÈCES SPÉCIALES . SPEZIALTEILE

PEZZI SPECIALI 9MM . SPECIAL PIECES . PIÈCES SPÉCIALES . SPEZIALTEILE

PL - 13,50 p. 280
Battiscopa
7x60 . 2,5"x24" Ret - R10 **185545** - Pearl
185543 - Rust

PL - 13,50 p. 280
Battiscopa
7x60 . 2,5"x24" Ret - R10 **185546** - Corten
185548 - Black

PL - 13,50 p. 280
Battiscopa
7x60 . 2,5"x24" Ret - R10 **185541** - Silver
185547 - Dark Blue

214



ICE POWDER MUD GREY GRAPHITE

BLOCK

Block reinventa i cementi nuvolati con tonalità polverose e superfici dallo spessore calibrato.

Block reinvents clouded cement with soft and powdery shades.

Block réinvente le ciment nuancé avec des teintes poudrées et des surfaces à épaisseur étudiée.

Block interpretiert wolkigen Zement neu mit pudrigen Farbtönen und sorgfältig abgestimmter Oberflächenstärke.



215

BLOCK

POWDER

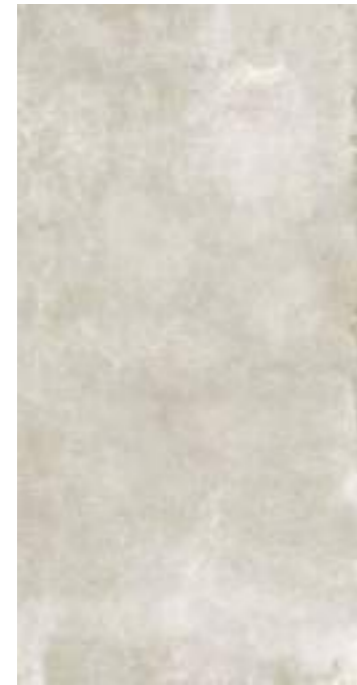

180575 - 60x120 . 24"x48"
Ret - R10 PM - 48,50



180605 - 90x90 . 36"x36" Ret - R10 PM - 50,00
180615 - 90x90 . 36"x36" Ret - GRIP PM - 50,00



180585 - 60x60 . 24"x24"
Ret - R10 PM - 39,90



180595 - 30x60 . 12"x24"
Ret - R10 PM - 39,90



GREY



180572 - 60x120 . 24"x48"
Ret - R10 PM - 48,50



180602 - 90x90 . 36"x36" Ret - R10 PM - 50,00
180612 - 90x90 . 36"x36" Ret - GRIP PM - 50,00



180582 - 60x60 . 24"x24"
Ret - R10 PM - 39,90



180592 - 30x60 . 12"x24"
Ret - R10 PM - 39,90

MUD



180573 - 60x120 . 24"x48"
Ret - R10 PM - 48,50



180603 - 90x90 . 36"x36" Ret - R10 PM - 50,00
180613 - 90x90 . 36"x36" Ret - GRIP PM - 50,00



180583 - 60x60 . 24"x24"
Ret - R10 PM - 39,90



180593 - 30x60 . 12"x24"
Ret - R10 PM - 39,90

GRAPHITE



180574 - 60x120 . 24"x48"
Ret - R10 PM - 48,50



180604 - 90x90 . 36"x36" Ret - R10 PM - 50,00
180614 - 90x90 . 36"x36" Ret - GRIP PM - 50,00



180584 - 60x60 . 24"x24"
Ret - R10 PM - 39,90



180594 - 30x60 . 12"x24"
Ret - R10 PM - 39,90

BLOCK



ICE



180571 - 60x120 . 24"x48"
Ret - R10 **PM - 48,50**



180601 - 90x90 . 36"x36" Ret - R10 **PM - 50,00**
180611 - 90x90 . 36"x36" Ret - GRIP **PM - 50,00**



180581 - 60x60 . 24"x24"
Ret - R10 **PM - 39,90**

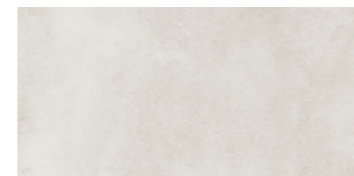

180591 - 30x60 . 12"x24"
Ret - R10 **PM - 39,90**

V2 SVILUPPO GRAFICO / PATTERNS

- 60x120 **7** Facce differenti / Different Patterns
- 60x60 **14** Facce differenti / Different Patterns
- 90x90 **7** Facce differenti / Different Patterns
- 30x60 **28** Facce differenti / Different Patterns

PEZZI SPECIALI 9MM . SPECIAL PIECES . PIÈCES SPÉCIALES . SPEZIALTEILE

inotech p. 280



Battiscopa **PL - 13,50**
7x60 . 2,5"x24" Ret - R10

- 152025** - Powder
- 152023** - Mud
- 152022** - Grey
- 152024** - Graphite
- 152021** - Ice



Battiscopa **PL - 15,50**
7x90 . 2,5"x36" Ret - R10

- 152035** - Powder
- 152033** - Mud
- 152032** - Grey
- 152034** - Graphite
- 152031** - Ice

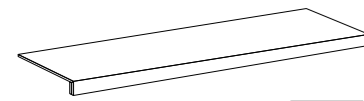

Angolo Gradino Costa Retta **PP - 250,00**
33x120 . 13"x48" - Ret - R10

- 180405** - Powder
- 180403** - Mud
- 180402** - Grey
- 180404** - Graphite
- 180401** - Ice

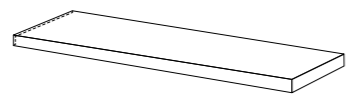

Angolo Gradino Costa Retta DX **PP - 300,00**
33x120 . 13"x48" - Ret - R10

- 180415** - Powder
- 180413** - Mud
- 180412** - Grey
- 180414** - Graphite
- 180411** - Ice

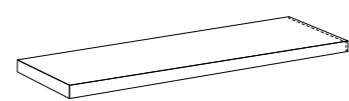

Angolo Gradino Costa Retta SX **PP - 300,00**
33x120 . 13"x48" - Ret - R10

- 180425** - Powder
- 180423** - Mud
- 180422** - Grey
- 180424** - Graphite
- 180421** - Ice



BLOCK 20MM



MUD



180133 - 90x90 . 36"x36"
Ret - GRIP PM - 77,50



181293 - 60x60 . 24"x24"
Ret - GRIP PM - 66,00

GRAPHITE



180134 - 90x90 . 36"x36"
Ret - GRIP PM - 77,50



181294 - 60x60 . 24"x24"
Ret - GRIP PM - 66,00

GREY



180132 - 90x90 . 36"x36"
Ret - GRIP PM - 77,50



181292 - 60x60 . 24"x24"
Ret - GRIP PM - 66,00

PEZZI SPECIALI 20MM . SPECIAL PIECES . PIÈCES SPÉCIALES . SPEZIALTEILE

infotech p. 280

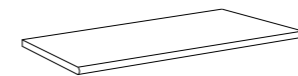

PP - 176,00

Gradino Toro
30x90 . 12"x36" Ret - GRIP
184123 - Mud
184122 - Grey
184124 - Graphite

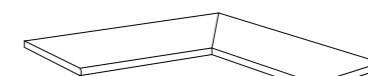

PP - 480,00

Angolo Grad. Toro Interno Dx-Sx
30x90 . 12"x36" Ret - GRIP
184133 - Mud
184132 - Grey
184134 - Graphite

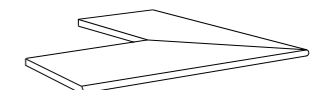

PP - 480,00

Angolo Grad. Toro Esterno Dx-Sx
30x90 . 12"x36" Ret - GRIP
184143 - Mud
184142 - Grey
184144 - Graphite

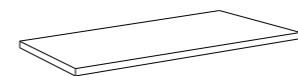

PP - 176,00

Gradino Costa Lucida
30x90 . 12"x36" Ret - GRIP
184153 - Mud
184152 - Grey
184154 - Graphite

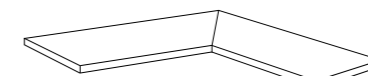

PP - 480,00

Angolo Grad. Costa Lucida Interno Dx-Sx
30x90 . 12"x36" Ret - GRIP
184163 - Mud
184162 - Grey
184164 - Graphite

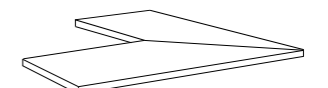

PP - 480,00

Angolo Grad. Costa Lucida Esterno Dx-Sx
30x90 . 12"x36" Ret - GRIP
184173 - Mud
184172 - Grey
184174 - Graphite

V2 **SVILUPPO GRAFICO / PATTERNS**
60x60 **14** Facce differenti / Different Patterns
90x90 **7** Facce differenti / Different Patterns

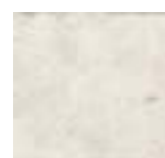

SBIANCATO



NATURALE

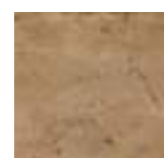

COTTO

PAVÉ BRICK

Pavé Brick reinterpreta l'effetto cotto con mattoni rustici, evocando il fascino del tempo e donando calore autentico agli spazi.

Pavé Brick reinterprets the terracotta effect with rustic bricks, evoking the charm of time and bringing authentic warmth to any space.

Pavé Brick réinterprète l'effet terre cuite avec des briques rustiques, évoquant le charme du temps et apportant une chaleur authentique aux espaces.

Pavé Brick interpretiert den Terrakotta-Effekt mit rustikalen Ziegeln, die den Charme der Zeit widerspiegeln und jedem Raum authentische Wärme verleihen.



PAVÉ BRICK



SBIANCATO

NATURALE

COTTO



180261 - 16,5x41 . 6"x16" R10

PM - 51,50



180262 - 16,5x41 . 6"x16" R10

PM - 51,50



180263 - 16,5x41 . 6"x16" R10

PM - 51,50

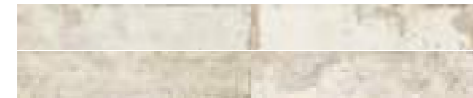

180271 - 8x41 . 3"x16" R10

PM - 57,50

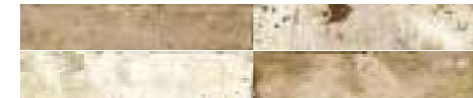

180272 - 8x41 . 3"x16" R10

PM - 57,50

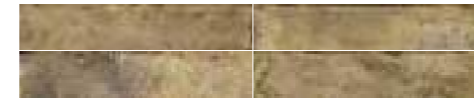

180273 - 8x41 . 3"x16" R10

PM - 57,50



SBIANCATO

NATURALE

COTTO



180281 - 16,5x41 . 6"x16" GRIP

PM - 51,50

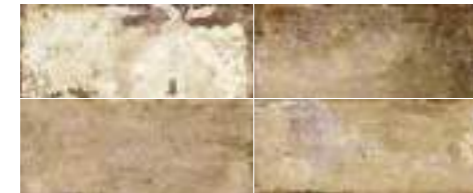

180282 - 16,5x41 . 6"x16" GRIP

PM - 51,50



180283 - 16,5x41 . 6"x16" GRIP

PM - 51,50

224

225

V3 SVILUPPO GRAFICO / PATTERNS

16,5x41 40 Facce differenti / Different Patterns
8x41 80 Facce differenti / Different Patterns

PEZZI SPECIALI . SPECIAL PIECES . PIÈCES SPÉCIALES . SPEZIALTEILE

infotech p. 280



PL - 14,00

Battiscopa
7x41 . 2,5"x16" R10

10 mm

180291 - Sbiancato
180292 - Naturale
180293 - Cotto

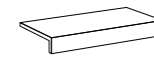

PL - 70,00

Elemento a "L"
15x30 . 6"x12" GRIP

9 mm

180301 - Sbiancato
180302 - Naturale
180303 - Cotto



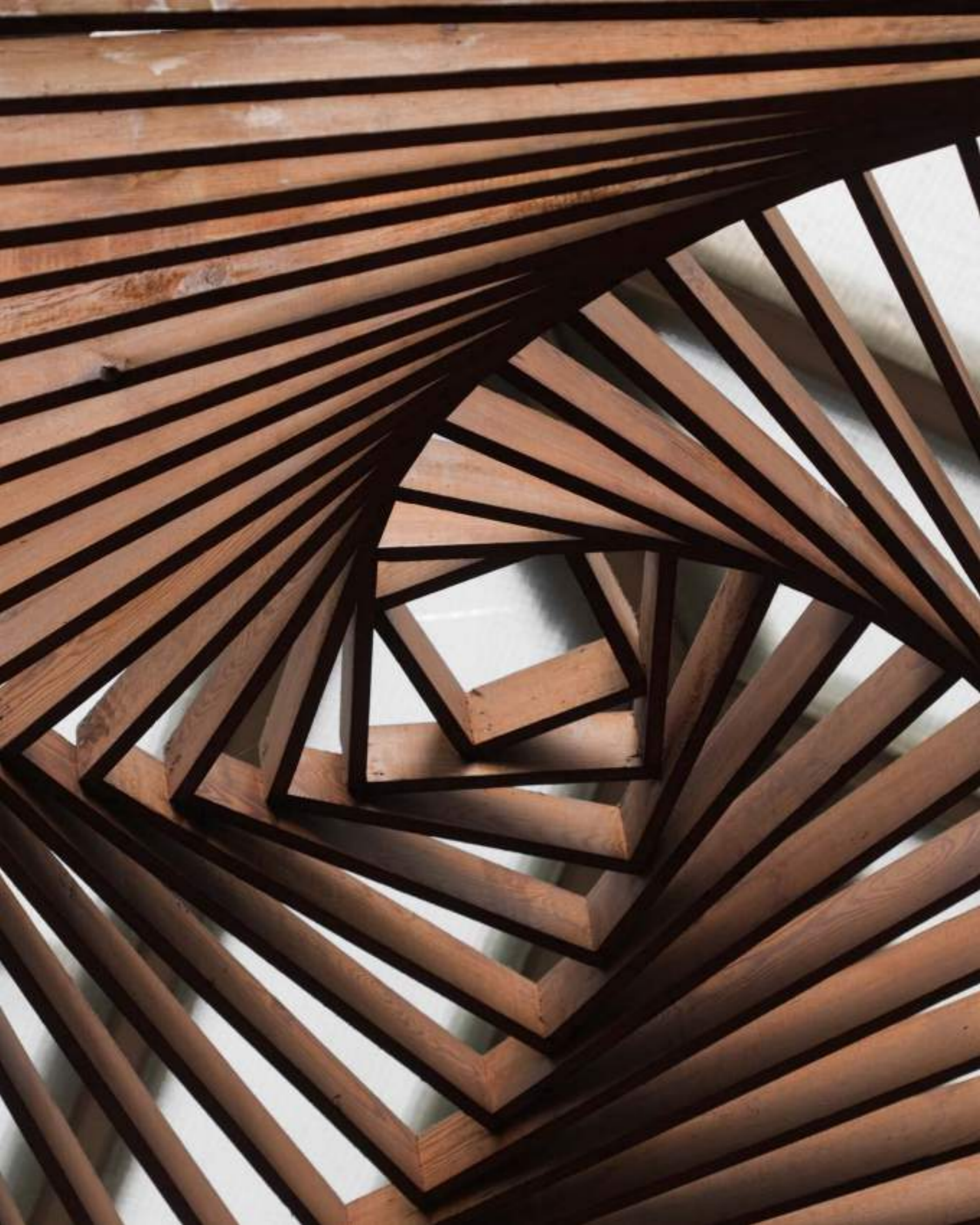

WOODLEGNI

227

LA THUILE	228
P.ARKETT	232
SHER_WOOD	238
TRONÇAIS	242
SILVIS	246



PINO FRASSINO ROVERE DOUSSIÉ

LA THUILLE

La Thuille reinventa il legno con sobrietà ed eleganza, esaltando venature e texture materiche per superfici ricche di profondità, luce e autenticità.

La Thuille reinvents wood with subtlety and elegance, highlighting grains and material textures for surfaces full of depth, light, and authenticity.

La Thuille réinvente le bois avec sobriété et élégance, mettant en valeur les veines et les textures matérielles pour des surfaces riches en profondeur, lumière et authenticité.

La Thuille interpretiert Holz neu mit Zurückhaltung und Eleganz, wobei Maserungen und materielle Texturen hervorgehoben werden, um Oberflächen voller Tiefe, Licht und Authentizität zu schaffen.



LA THUILE

PINO



151271 - 30x120 . 12"x48" Ret - MATT

PM - 47,50



151281 - 20x120 . 8"x48" Ret - MATT

PM - 47,50



151301 - 9,7x53 . 4"x21" Chevron Ret - MATT

PM - 85,00

FRASSINO



151272 - 30x120 . 12"x48" Ret - MATT

PM - 47,50



151282 - 20x120 . 8"x48" Ret - MATT

PM - 47,50



151302 - 9,7x53 . 4"x21" Chevron Ret - MATT

PM - 85,00



ROVERE



151273 - 30x120 . 12"x48" Ret - MATT

PM - 47,50



151283 - 20x120 . 8"x48" Ret - MATT

PM - 47,50



151303 - 9,7x53 . 4"x21" Chevron Ret - MATT

PM - 85,00

DOUSSIÉ



151275 - 30x120 . 12"x48" Ret - MATT

PM - 47,50



151285 - 20x120 . 8"x48" Ret - MATT

PM - 47,50



151305 - 9,7x53 . 4"x21" Chevron Ret - MATT

PM - 85,00

230

231

V2

SVILUPPO GRAFICO / PATTERNS

30x120
20x120
9,7x53

20 Facce differenti / Different Patterns
30 Facce differenti / Different Patterns
120 Facce differenti / Different Patterns

PEZZI SPECIALI 9MM . SPECIAL PIECES . PIÈCES SPÉCIALES . SPEZIALTEILE

 info tech p. 280
Battiscopa
6x120 . 2"x24" Ret - MATT

PL - 22,00

151371 - Pino
151372 - Frassino
151373 - Rovere
151375 - Doussié

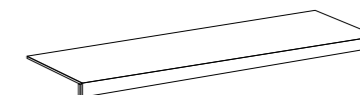
Gradino Costa Retta
33x120 . 13"x48" Ret - MATT

PP - 250,00

151341 - Pino
151342 - Frassino
151343 - Rovere
151345 - Doussié

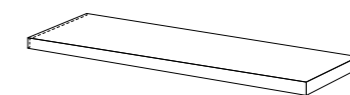
Angolo Gradino Costa Retta Dx
33x120 . 13"x48" Ret - MATT

PP - 300,00

151351 - Pino
151352 - Frassino
151353 - Rovere
151355 - Doussié

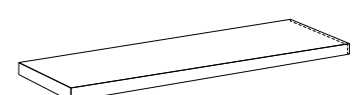
Angolo Gradino Costa Retta Sx
33x120 . 13"x48" Ret - MATT

PP - 300,00

151361 - Pino
151362 - Frassino
151363 - Rovere
151365 - Doussié

 p. 285

INDICAZIONI DI POSA

Laying instructions .
Indications de pose .
Hinweise zur Verlegung .



LINZ



THUN



TIROL

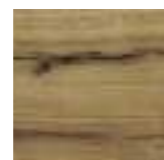

GRAZ

P_ARKETT

P.arkett nasce dal legno autentico: venature, nodi e calore del rovere austriaco sono riprodotti con cura, in colori eleganti e superfici versatili.

P.arkett is inspired by authentic wood: the grains, knots, and warmth of Austrian oak are carefully reproduced in elegant colors and versatile surfaces.

P.arkett s'inspire du bois authentique : veines, nœuds et chaleur du chêne autrichien sont reproduits avec soin dans des couleurs élégantes et des surfaces polyvalentes.

P.arkett orientiert sich am authentischen Holz: Maserung, Äste und Wärme der österreichischen Eiche werden sorgfältig in eleganten Farben und vielseitigen Oberflächen nachgebildet.



PARKETT

LINZ



196021 - 30x120 . 12"x48" Ret - SATIN PM - 47,50

196031 - 30x120 . 12"x48" Ret - SOFT GRIP PM - 47,50



196041 - 20x120 . 8"x48" Ret - SATIN PM - 47,50

196051 - 20x120 . 8"x48" Ret - SOFT GRIP PM - 47,50



196071 - 60x120 . 24"x48" Linz Ret - Bambus SATIN PM - 63,00

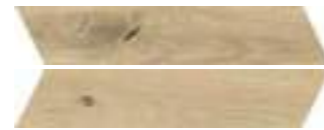

196101 - 9,7x53 . 4"x21" Chevron Ret - SATIN PM - 85,00

234

THUN



196022 - 30x120 . 12"x48" Ret - SATIN PM - 47,50

196032 - 30x120 . 12"x48" Ret - SOFT GRIP PM - 47,50



196042 - 20x120 . 8"x48" Ret - SATIN PM - 47,50

196052 - 20x120 . 8"x48" Ret - SOFT GRIP PM - 47,50



196075 - 60x120 . 24"x48" Mix Ret - Bambus SATIN PM - 63,00

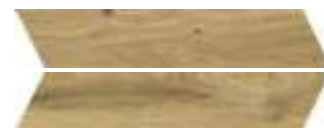

196102 - 9,7x53 . 4"x21" Chevron Ret - SATIN PM - 85,00

V3

SVILUPPO GRAFICO / PATTERNS

30x120
20x120
9,7x53
60x120 Bambus

28 Facce differenti / Different Patterns
42 Facce differenti / Different Patterns
192 Facce differenti / Different Patterns
7 Facce differenti / Different Patterns



TIROL



196023 - 30x120 . 12"x48" Ret - SATIN PM - 47,50

196033 - 30x120 . 12"x48" Ret - SOFT GRIP PM - 47,50



196043 - 20x120 . 8"x48" Ret - SATIN PM - 47,50

196053 - 20x120 . 8"x48" Ret - SOFT GRIP PM - 47,50



196075 - 60x120 . 24"x48" Mix Ret - Bambus SATIN PM - 63,00

GRAZ



196024 - 30x120 . 12"x48" Ret - SATIN PM - 47,50

196034 - 30x120 . 12"x48" Ret - SOFT GRIP PM - 47,50



196044 - 20x120 . 8"x48" Ret - SATIN PM - 47,50

196054 - 20x120 . 8"x48" Ret - SOFT GRIP PM - 47,50



196075 - 60x120 . 24"x48" Mix Ret - Bambus SATIN PM - 63,00



196103 - 9,7x53 . 4"x21" Chevron Ret - SATIN PM - 85,00



196104 - 9,7x53 . 4"x21" Chevron Ret - SATIN PM - 85,00

235

infotech p. 285

INDICAZIONI DI POSA
Laying instructions .
Indications de pose .
Hinweise zur Verlegung .

PARKETT

PEZZI SPECIALI 9MM . SPECIAL PIECES . PIÈCES SPÉCIALES . SPEZIALTEILE

infotech p. 280

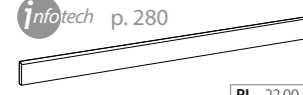

PL - 22,00

Battiscopa
6x120 . 2"x48" Ret - SATIN

196181 - Linz
196182 - Thun
196183 - Tirol
196184 - Graz

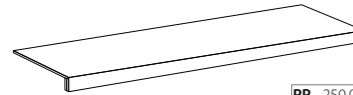

PP - 250,00

Gradino Costa Retta
33x120 . 13"x48" Ret - SATIN

196111 - Linz
196112 - Thun
196113 - Tirol
196114 - Graz

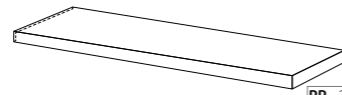

PP - 300,00

Angolo Gradino Costa Retta DX
33x120 . 13"x48" Ret - SATIN

196121 - Linz
196122 - Thun
196123 - Tirol
196124 - Graz

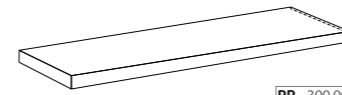

PP - 300,00

Angolo Gradino Costa Retta SX
33x120 . 13"x48" Ret - SATIN

196171 - Linz
196172 - Thun
196173 - Tirol
196174 - Graz

PARKETT 20MM

GRES PORCELLANATO . PORCELAIN STONEWARE . GRÉS CÉRAME . FEINSTEINZEUG



THUN



196142 40x120 . 16"x48" Ret - GRIP

PM - 77,50

GRAZ



196144 40x120 . 16"x48" Ret - GRIP

PM - 77,50



SVILUPPO GRAFICO / PATTERNS

40x120

28 Facce differenti / Different Patterns

PEZZI SPECIALI 20MM . SPECIAL PIECES . PIÈCES SPÉCIALES . SPEZIALTEILE

infotech p. 280

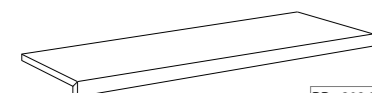

PP - 302,00

Gradino costa retta
33x120 . 13"x48" Ret - GRIP

196192 - Thun
196194 - Graz

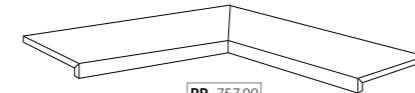

PP - 757,00

Angolo Interno Gradino costa retta
33x120 . 13"x48" Ret - GRIP

196202 - Thun
196204 - Graz



PP - 168,00

Angolo Esterno Gradino costa retta
33x33 . 13"x13" Ret - GRIP

196212 - Thun
196214 - Graz



BIANCO NEUTRO MIELE COGNAC DUNA SAGE

TRONÇAIS

Tronçais celebra la maestosità del rovere con venature delicate e una palette sofisticata ispirata alla foresta francese.

Tronçais celebrates the majesty of oak with delicate grains and a sophisticated palette inspired by the French forest.

Tronçais célèbre la majesté du chêne avec des veines délicates et une palette sophistiquée inspirée de la forêt française.

Tronçais feiert die Majestät der Eiche mit feinen Maserungen und einer anspruchsvollen Farbpalette, inspiriert vom französischen Wald.



TRONÇAIS

BIANCO



187980 - 20x120 . 8"x48" Ret - MATT

PM - 47,50

188400 - 20x120 . 8"x48" Ret - GRIP

PM - 49,00

NEUTRO



187981 - 20x120 . 8"x48" Ret - MATT

PM - 47,50

188401 - 20x120 . 8"x48" Ret - GRIP

PM - 49,00

MIELE



187982 - 20x120 . 8"x48" Ret - MATT

PM - 47,50

188402 - 20x120 . 8"x48" Ret - GRIP

PM - 49,00

COGNAC



187983 - 20x120 . 8"x48" Ret - MATT

PM - 47,50

188403 - 20x120 . 8"x48" Ret - GRIP

PM - 49,00



DUNA



187984 - 20x120 . 8"x48" Ret - MATT

PM - 47,50

188404 - 20x120 . 8"x48" Ret - GRIP

PM - 49,00

SAGE



187985 - 20x120 . 8"x48" Ret - MATT

PM - 47,50

244

245

infotech p. 285

INDICAZIONI DI POSA

Laying instructions .
Indications de pose .
Hinweise zur Verlegung .

PEZZI SPECIALI 9MM . SPECIAL PIECES . PIÈCES SPÉCIALES . SPEZIALTEILE

infotech p. 280



PL - 22,00

Battiscopa
6x120 . 2"x48" Ret - MATT

188460 - Bianco
188461 - Neutro
188462 - Miele
188463 - Cognac
188464 - Duna
188465 - Sage

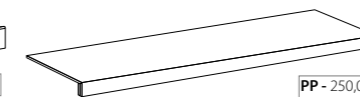

PP - 250,00

Gradino Costa Retta
33x120 . 13"x48" Ret - MATT

188410 - Bianco
188411 - Neutro
188412 - Miele
188413 - Cognac
188414 - Duna
188415 - Sage

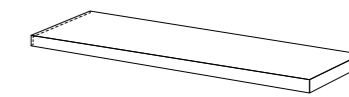

PP - 300,00

Angolo Gradino Costa Retta DX
33x120 . 13"x48" Ret - MATT

188430 - Bianco
188431 - Neutro
188432 - Miele
188433 - Cognac
188434 - Duna
188435 - Sage

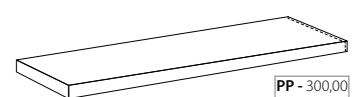

PP - 300,00

Angolo Gradino Costa Retta SX
33x120 . 13"x48" Ret - MATT

188450 - Bianco
188451 - Neutro
188452 - Miele
188453 - Cognac
188454 - Duna
188455 - Sage

V2



SVILUPPO GRAFICO / PATTERNS

20x120

30 Facce differenti / Different Patterns

246



ACERO



ROVERE



LARICE

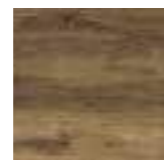

MOGANO



NOCE

SILVIS

Silvis unisce l'eleganza del legno autentico a superfici versatili e materiche dalle tonalità calde.

Silvis combines the elegance of authentic wood with versatile, textured surfaces in warm tones.

Silvis allie l'élégance du bois authentique à des surfaces polyvalentes et texturées aux teintes chaudes.

Silvis vereint die Eleganz von echtem Holz mit vielseitigen, strukturierten Oberflächen in warmen Farbtönen.



247

SILVIS

ACERO



181641 - 30x120 . 12°x48° Ret - R10

PM - 47,50



181651 - 20x120 . 8°x48° Ret - R10

PM - 47,50



183401 - 20x120 . 8°x48° Fascia Modulo Rete Ret - R10

PP - 24,00

ROVERE



181642 - 30x120 . 12°x48° Ret - R10

PM - 47,50



181652 - 20x120 . 8°x48° Ret - R10

PM - 47,50

181672 - 20x120 . 8°x48° Ret - GRIP

PM - 49,00



183402 - 20x120 . 8°x48° Fascia Modulo Rete Ret - R10

PP - 24,00



LARICE



181643 - 30x120 . 12°x48° Ret - R10

PM - 47,50



181653 - 20x120 . 8°x48° Ret - R10

PM - 47,50

181673 - 20x120 . 8°x48° Ret - GRIP

PM - 49,00



183403 - 20x120 . 8°x48° Fascia Modulo Rete Ret - R10

PP - 24,00

MOGANO



181644 - 30x120 . 12°x48° Ret - R10

PM - 47,50



181654 - 20x120 . 8°x48° Ret - R10

PM - 47,50



183404 - 20x120 . 8°x48° Fascia Modulo Rete Ret - R10

PP - 24,00

SILVIS

NOCE



181645 - 30x120 . 12°x48° Ret - R10

PM - 47,50



181655 - 20x120 . 8°x48° Ret - R10

PM - 47,50

181675 - 20x120 . 8°x48° Ret - GRIP

PM - 49,00



183405 - 20x120 . 8°x48° Fascia Modulo Rete Ret - R10

PP - 24,00



SILVIS 20MM

GRES PORCELLANATO . PORCELAIN STONEWARE . GRÈS CÉRAME . FEINSTEINZEUG



ROVERE



181872 - 40x120 . 16°x48° Ret - GRIP

PM - 77,50

LARICE



181873 - 40x120 . 16°x48° Ret - GRIP

PM - 77,50

NOCE



181875 - 40x120 . 16°x48° Ret - GRIP

PM - 77,50

V3

SVILUPPO GRAFICO / PATTERNS

30x120 12 Facce differenti / Different Patterns
 20x120 18 Facce differenti / Different Patterns
 40x120 12 Facce differenti / Different Patterns

infotech p. 285

INDICAZIONI DI POSA

Laying instructions .
 Indications de pose .
 Hinweise zur Verlegung .

PEZZI SPECIALI 9MM . SPECIAL PIECES . PIÈCES SPÉCIALES . SPEZIALTEILE

infotech p. 280

Battiscopa
6x120 . 2°x48° Ret - R10

181711 - Acero
 181712 - Rovere
 181713 - Larice
 181714 - Mogano
 181715 - Noce

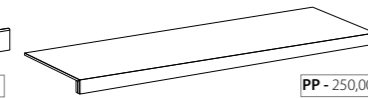
Gradino Costa Retta
33x120 . 13°x48° Ret - R10

181681 - Acero
 181682 - Rovere
 181683 - Larice
 181684 - Mogano
 181685 - Noce

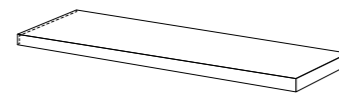
Angolo Gradino Costa Retta DX
33x120 . 13°x48° Ret - R10

181691 - Acero
 181692 - Rovere
 181693 - Larice
 181694 - Mogano
 181695 - Noce

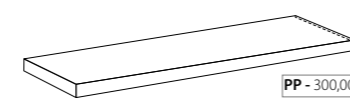
Angolo Gradino Costa Retta SX
33x120 . 13°x48° Ret - R10

181701 - Acero
 181702 - Rovere
 181703 - Larice
 181704 - Mogano
 181705 - Noce

infotech p. 285

INDICAZIONI DI POSA

Laying instructions .
 Indications de pose .
 Hinweise zur Verlegung .

PEZZI SPECIALI 20MM . SPECIAL PIECES . PIÈCES SPÉCIALES . SPEZIALTEILE

infotech p. 280

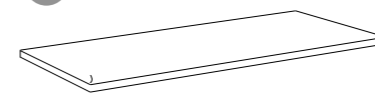
Gradino Toro
40x120 . 16°x48° Ret - GRIP

PP - 220,00

184362 - Rovere
 184363 - Larice
 184365 - Noce

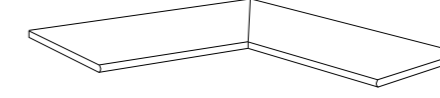
Angolo Grad. Toro Interno Dx-Sx
40x120 . 16°x48° Ret - GRIP

PP - 510,00

184372 - Rovere
 184373 - Larice
 184375 - Noce

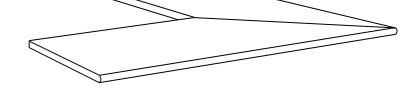
Angolo Grad. Toro Esterno Dx-Sx
40x120 . 16°x48° Ret - GRIP

PP - 510,00

184382 - Rovere
 184383 - Larice
 184385 - Noce

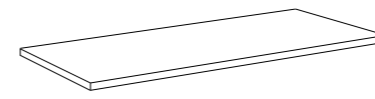
Gradino Costa Lucida
40x120 . 16°x48° Ret - GRIP

PP - 220,00

184392 - Rovere
 184393 - Larice
 184395 - Noce

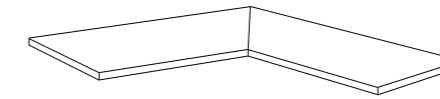
Angolo Grad. Costa Lucida Interno Dx-Sx
40x120 . 16°x48° Ret - GRIP

PP - 510,00

184402 - Rovere
 184403 - Larice
 184405 - Noce

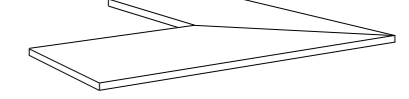
Angolo Grad. Costa Lucida Esterno Dx-Sx
40x120 . 16°x48° Ret - GRIP

PP - 510,00

184412 - Rovere
 184413 - Larice
 184415 - Noce



SPESSORATI 1.4/2.0 ²⁵³

1.4
OUTDOOR 20MM

254
258



BIANCO



GRIGIO CENERE

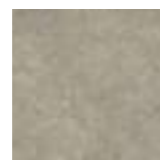

GREIGE



GREY



NERO SCURO



TECH-4S

1.4

1.4 unisce tecnologia e resistenza in 14 mm di spessore, offrendo superfici robuste e versatili per ambienti contemporanei dal grande impatto.

1.4 combines technology and strength in 14 mm thickness, offering robust and versatile surfaces for contemporary spaces with strong visual impact.

1.4 allie technologie et résistance dans un format de 14 mm, offrant des surfaces robustes et polyvalentes pour des espaces contemporains au fort impact visuel.

1.4 vereint Technologie und Widerstandskraft in 14 mm Stärke und bietet robuste, vielseitige Oberflächen für zeitgenössische Räume mit starker visueller Wirkung.



1.4



BIANCO



198611 - 60x60 . 24"x24" Ret
PM - 56,00

GREY



198612 - 60x60 . 24"x24" Ret
PM - 56,00

GRIGIO CENERE



198614 - 60x60 . 24"x24" Ret
PM - 56,00

NERO SCURO

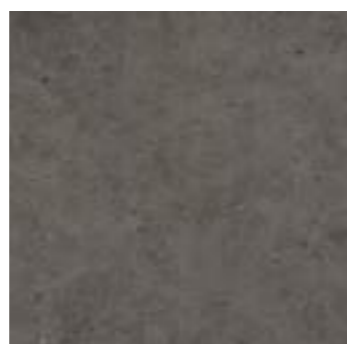

498625 - 60x60 . 24"x24" Ret
PM - 56,00

GREIGE



198613 - 60x60 . 24"x24" Ret
PM - 56,00

TECH-4S

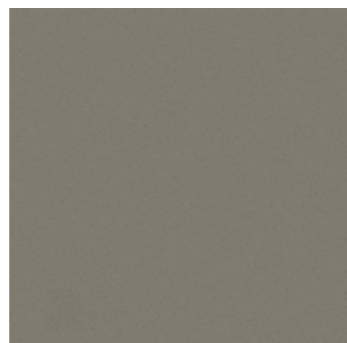

198615 - 60x60 . 24"x24" Ret
PM - 56,00

256

257

V2

SVILUPPO GRAFICO / PATTERNS

- 60x60 Bianco **20** Facce differenti / Different Patterns
- 60x60 Grigio Cenere **20** Facce differenti / Different Patterns
- 60x60 Greige **10** Facce differenti / Different Patterns
- 60x60 Grey **14** Facce differenti / Different Patterns
- 60x60 Nero Scuro **10** Facce differenti / Different Patterns
- 60x60 Tech-4S **1** Facce differenti / Different Patterns



258

259



OUTDOOR 20MM

OUTDOOR 2 cm presenta in sintesi la gamma cromatica, le collezioni e i formati disponibili per esterni, con superfici robuste e versatili, ideali per ogni contesto progettuale.

OUTDOOR 2 cm summarizes the color range, collections, and formats available for outdoor use, with robust and versatile surfaces ideal for any design context.

OUTDOOR 2 cm présente en synthèse la palette de couleurs, les collections et les formats disponibles pour l'extérieur, avec des surfaces robustes et polyvalentes, adaptées à tous les projets.

OUTDOOR 2 cm fasst die Farbpalette, Kollektionen und verfügbaren Formate für den Außenbereich zusammen, mit robusten und vielseitigen Oberflächen, ideal für jedes Projektumfeld.

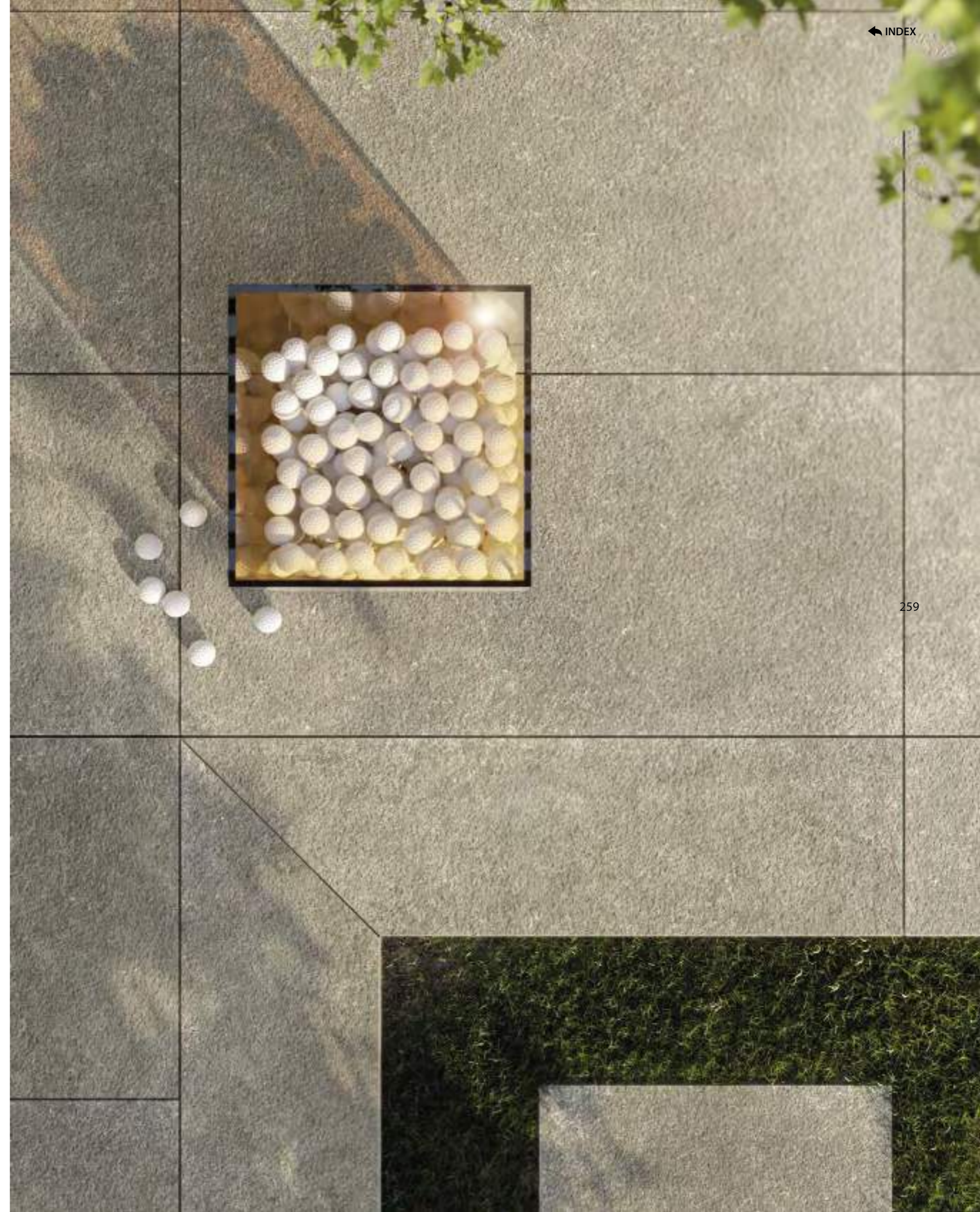

OUTDOOR 20MM



STONEPIETRE

MYSTONE

60x120 60x60

MYSTONE Sand MYSTONE Silver

ARDENNES

60x120

60x60

ARDENNES Pearl ARDENNES Cream ARDENNES Nut ARDENNES Grey

ARDENNES Cream ARDENNES Nut

CREMA LUNA

90x90 60x120 60x60

CREMA LUNA Cream CREMA LUNA Mist CREMA LUNA Urban

CHANTILLY

60x90

CHANTILLY Mélange CHANTILLY Crème CHANTILLY Beige CHANTILLY Mélange de Nuit

PAVE' DELLE ALPI

60x120* 60x90

60x60

PAVÉ DELLE ALPI Valmalenco PAVÉ DELLE ALPI Porfido* PAVÉ DELLE ALPI Pietra Lusema* PAVÉ DELLE ALPI Sestriere* PAVÉ DELLE ALPI Quarzo Grigio PAVÉ DELLE ALPI Quarzo Multicolore

PAVÉ DELLE ALPI Sestriere PAVÉ DELLE ALPI Quarzo Grigio PAVÉ DELLE ALPI Quarzo Multicolore

AMBOISE

90x90 Chipped Edge 60x90 Chipped Edge

AMBOISE Beige AMBOISE Grigio AMBOISE Bianco AMBOISE Oro

AR_GENT

90x90

AR_GENT Greige AR_GENT Ash AR_GENT Cream

CHATEAUX

90x90 60x90 60x60

CHATEAUX Taupe CHATEAUX Antracite

MARBLEMARMI

NAVONA

60x120

NAVONA Bianco NAVONA Beige

WOODLEGNI

P-ARKETT

40x120

P-ARKETT Thun P-ARKETT Graz

SILVIS

40x120

SILVIS Rovere SILVIS Larice SILVIS Noce

CONTEMPORARYCONTEMPORANEO

CON_CRETE3

90x90

60x120

60x60

CON_CRETE3 Bianco CON_CRETE3 Cappuccino CON_CRETE3 Grigio Baslto CON_CRETE3 Grigio Cenere

CON_CRETE3 Bianco CON_CRETE3 Cappuccino CON_CRETE3 Grigio Baslto

CON_CRETE3 Bianco CON_CRETE3 Cappuccino CON_CRETE3 Grigio Baslto CON_CRETE3 Grigio Cenere CON_CRETE3 Beige

BLOCK

90x90 60x60

BLOCK Mud BLOCK Grey BLOCK Graphite



INFORMAZIONITECNICHE

TECHNICAL INFORMATION . INFORMATION TECHNIQUE . TECHNISCHE INFORMATIONEN

SUPERFICI SENZA BARRIERE TRA INTERNI ED ESTERNI	264	TABELLA DEI CALIBRI	278
Surfaces without barriers between indoor and outdoor.		Calibre table.	
Surfaces sans barrières entre l'intérieur et l'extérieur.		Tableau des calibres.	
Oberflächen ohne Barrieren zwischen innen und außen.		Tabelle der Kaliber.	
SOFT GRIP TUTTI I PREGI DELLA CERAMICA	266	LA CLASSIFICAZIONE DELLE TONALITÀ	279
Soft grip all the qualities of ceramics.		Color Shade Variation Guide.	
Soft Grip toutes les qualités de la céramique.		Classification des tonalités.	
Soft Grip die alle Werte der Keramik.		Farbspiel-Klassifizierung.	
LO SPESSORE 14 MM	267	I PEZZI SPECIALI	280
Thickness 14 mm		Trims.	
Épaisseur 14 mm		Les pièces spéciales.	
Dicke 14 mm		Die Formteile.	
LO SPESSORE 20 MM	268	CONSIGLI DI POSA	284
Thickness 20 mm		Laying instructions.	
Épaisseur 20 mm		Indications de pose.	
Dicke 20 mm		Hinweise zur Verlegung.	
LE CARATTERISTICHE TECNICHE	270	INDICAZIONI DI POSA	285
Technical properties.		Laying suggestions.	
Caractéristiques techniques.		Conseils pour la pose.	
Technische Eigenschaften.		Verlegehinweise.	
CARATTERISTICHE TECNICHE DI SUPERFICIE	274	PULIZIA E MANUTENZIONE	286
Technical surface properties.		Cleaning and maintenance information.	
Caractéristiques techniques des surfaces.		Informations sur le nettoyage et l'entretien.	
Technische Eigenschaften der Oberfläche.		Informationen zur reinigung und pflege.	
CARATTERISTICHE TECNICHE DI SUPPORTO	277	CONDIZIONI GENERALI DI VENDITA E GARANZIE	290
Physical properties of the tile's body.		General sales conditions and guarantees.	
Caractéristiques techniques du corps du carreau.		Conditions générales de vente et garanties.	
Technische Eigenschaften des Scherbens.		Allgemeine Geschäfts- und Garantiebedingungen.	
		PACKING LIST	294

SUPERFICI SENZA BARRIERE TRA INTERNI ED ESTERNI.

SURFACES WITHOUT BARRIERS BETWEEN INDOOR AND OUTDOOR.
SURFACES SANS BARRIÈRES ENTRE L'INTÉRIEUR ET L'EXTÉRIEUR.
OBERFLÄCHEN OHNE BARRIEREN ZWISCHEN INNEN UND AUßEN.

264

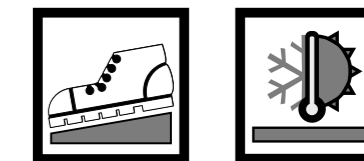
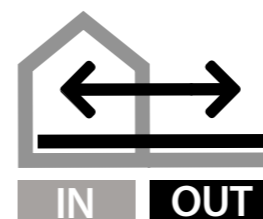

265

LE CARATTERISTICHE DI SUPERFICIE DELLE COLLEZIONI SICHENIA CONSENTONO DI PASSARE DALLO SPAZIO INTERNO A QUELLO ESTERNO MANTENENDO ARMONIE DI COLORE E GEOMETRIE ARCHITETTONICHE. Le superfici per esterno sono progettate per resistere nel tempo agli agenti atmosferici e per **garantire sicurezza di appoggio del piede** con e senza calzatura. Le soluzioni antiscivolo certificate R11 A+B+C garantiscono aderenza sia in condizioni di superficie asciutta che bagnata mantenendo coerenza estetica con le superfici interne di tutti gli ambienti sia pubblici che privati. La gamma di Sichenia comprende anche le **superfici con spessore 20 mm** ideate per risolvere con stile e semplicità le problematiche di posa sui fondi esterni naturali.

THE CHARACTERISTICS OF THE SURFACES OF THE SICHENIA COLLECTIONS CREATE A CONSISTENT LOOK BETWEEN INTERIOR AND EXTERIOR SPACES, MAINTAINING ARCHITECTURAL GEOMETRIES AND HARMONIOUS COLOURS. The outdoor surfaces are designed to resist to atmospheric agents in time and to **guarantee safety** with or without footwear. The non-slip solutions, certified R11 A+B+C, guarantee adherence when the surface is both wet and dry, maintaining a coherent and harmonious appearance with the internal surfaces of both private and public spaces. The Sichenia range also includes **20 mm thick surfaces** designed to offer a simple and stylish solution when laying on natural outdoor surfaces.

LES CARACTÉRISTIQUES DES SURFACES DES COLLECTIONS SICHENIA PERMETTENT DE PASSER DE L'INTÉRIEUR À L'EXTÉRIEUR TOUT EN PRÉSERVANT LES HARMONIES DE COULEUR ET LES GÉOMÉTRIES ARCHITECTURALES. Les surfaces pour l'extérieur sont conçues pour résister dans le temps aux agents atmosphériques et pour **garantir la sécurité d'appui du pied** avec et sans chaussures. Les solutions antidérapantes certifiées R11 A+B+C garantissent l'adhérence dans des conditions de surface sèche et mouillée en préservant la cohérence esthétique avec les surfaces internes des espaces publics et privés. La gamme de Sichenia comprend également les surfaces d'une **épaisseur de 20 mm** conçues pour résoudre avec style et simplicité les problèmes de pose sur les substrats extérieurs naturels.

DIE MERKMALE DER FLÄCHEN DER SICHENIA-KOLLEKTIONEN GESTATTEN EINEN ÜBERGANG VON INNEN- AUF AUSSENÄUßEN UNTER EINHALTUNG DER FARBENHARMONIE UND DER ARCHITEKTONISCHEN FORMEN. Die Flächen für außen sind so ausgelegt, dass sie langfristig gegen Witterungseinflüsse beständig sind und eine **ausgezeichnete Standsicherheit für die Füße**, mit und ohne Schuhe, gewährleisten. Die rutschfesten R11 A+B+C-zertifizierten Lösungen garantieren sowohl bei trockener als auch bei nasser Oberfläche eine ausgezeichnete Haftung, unter Beibehaltung des ästhetischen Zusammenhangs mit den Innenflächen aller öffentlichen und privaten Umgebungen. Das Sichenia-Programm enthält auch Flächen mit einer **Stärke von 20 mm**, die geschaffen wurden, um mit Stil und Einfachheit Verlegeprobleme auf externen Naturuntergründen zu lösen.

LA NANOTECNOLOGIA CHE UNISCE IN UN SOLO PRODOTTO TUTTI I PREGI DELLA CERAMICA.

THE NANOTECHNOLOGY THAT COMBINES ALL THE QUALITIES OF CERAMICS INTO ONE PRODUCT.
 NANOTECHNOLOGIE QUI COMBINE TOUTES LES QUALITÉS DE LA CÉRAMIQUE EN UN SEUL PRODUIT.
 DIE NANOTECHNOLOGIE, DIE ALLE WERTE DER KERAMIK IN EINEM PRODUKT VEREINT.



WATCH ME NOW



266

IMMAGINARE DI UTILIZZARE LA STESSA SUPERFICIE PER PIÙ DESTINAZIONI D'USO È ORA POSSIBILE GRAZIE ALL'EVOLUZIONE DELLO SMALTO UTILIZZATO NELLE COLLEZIONI SICHENIA. La finitura Soft Grip si presenta morbida e piacevole al tatto ma al tempo stesso resistente allo scivolamento, con elevate prestazioni tecniche. Questa nuova tecnologia permette di posare la stessa collezione in diverse aree, può essere utilizzata sia in ambienti interni che esterni, residenziali e commerciali, rendendo armoniose ed equilibrate tutte le zone. Non c'è più bisogno di scegliere le collezioni in base alle destinazioni d'uso, grazie alla nanotecnologia targata Sichenia è possibile avere le migliori caratteristiche della ceramica in un solo prodotto. Fondamentale aspetto è anche il notevole risparmio in termini di spazio dato che non sarà più necessario rifornire il magazzino con diversi prodotti ma ne basterà solo uno dotato di tecnologia "Soft-Grip" che soddisferà qualsiasi richiesta.

NOW IT IS POSSIBLE TO IMAGINE THE SAME SURFACE FOR MULTIPLE USES, THANKS TO THE REVOLUTIONARY GLAZE USED IN SICHENIA COLLECTIONS. The Soft Grip finish is smooth and pleasant to the touch but at the same time has anti-slip properties and high-end technical features. This new technology allows the same product to be placed in different areas, it can be used both indoors and outdoors, residential and commercial and makes all areas harmonious and balanced. There's no more need to choose collections according to the intended use, thanks to Sichenia's nanotechnology it is now possible to have the best characteristics of ceramics in one product. These intrinsic properties of the product also bring about substantial benefits when it comes to warehouse space management, as it is no longer necessary to have different products in stock for specific uses (indoor and outdoor), but only one version supplied with "Soft-Grip" technology that will satisfy any request.

IMAGINER UTILISER LA MÊME SURFACE POUR DE MULTIPLES USAGES EST DÉSORMAIS POSSIBLE GRÂCE À L'ÉVOLUTION DE L'ÉMAIL UTILISÉ DANS LES COLLECTIONS SICHENIA. La finition Soft Grip est douce et agréable au toucher mais en même temps résistante au glissement, avec des performances techniques élevées. Cette nouvelle technologie permet à la même collection d'être installée dans des zones différentes, elle peut être utilisée aussi bien à l'intérieur qu'à l'extérieur, résidentielle et commerciale, rendant toutes les zones harmonieuses et équilibrées. Il n'est plus nécessaire de choisir des collections en fonction de l'utilisation prévue, grâce à la nanotecnologie de Sichenia, il est possible d'avoir les meilleures caractéristiques de la céramique dans un seul produit. Le gain considérable en termes d'espace est également un aspect fondamental puisqu'il ne sera plus nécessaire d'approvisionner l'entrepôt en différents produits mais un seul équipé de la technologie "Soft-Grip" suffira à satisfaire toute demande.

STELLEN SIE SICH VOR, DIESELBE OBERFLÄCHE FÜR MEHRERE OBERFLÄCHEN ZU VERWENDEN, JETZT IST ES MÖGLICH, DANK DER REVOLUTIONÄREN EMAILLE, DIE SICHENIA IN SEINEN KOLLEKTIONEN VERWENDET. Die Soft-Grip-Oberfläche ist glatt und fühlt sich angenehm an, verfügt aber gleichzeitig über Anti Slip-Eigenschaften und hohe technische Leistungen. Dank dieser neuen Technologie wird es von nun an machbar sein, ein und dieselbe Kollektion in verschiedenen Bereichen zu verwenden, sowohl im Innen- als auch im Außenbereich, sowohl im privaten als auch im gewerblichen Bereich, wodurch alle Wohnbereiche harmonisch und ausgewogen werden. Es ist nicht mehr notwendig, die Kollektionen je nach Verwendungszweck auszuwählen, dank Sichenia's Nanotechnologie ist es möglich, die besten Eigenschaften von Keramiken in einem Produkt. Ein weiterer wichtiger Aspekt ist darüber hinaus die Platzersparnis im Lager, da nicht mehr verschiedene Produkte benötigt werden, sondern nur noch eines, das mit der "Soft-Grip"-Technologie ausgestattet ist und jeder Anforderung gerecht wird.

14MM ESTREMAMENTE RESISTENTE

14MM SICHENIA EXTREMELY RESISTANT
 14MM SICHENIA EXTRÊMEMENT RÉSISTANT
 14MM SICHENIA EXTREM BESTÄNDIG

14
mm

Finissime polveri colorate, compattate con grandi presse idrauliche e greificate tramite la cottura a 1250°C, danno vita a **SICHENIA 14mm** il gres porcellanato spessore 14mm. Il nostro processo produttivo permette a **SICHENIA 14mm** di essere tre volte più resistente del tradizionale 10mm.

. **SICHENIA 14mm** ha un carico di rottura di 600kg rispetto ai 200kg del gres 10mm e presenta elevati livelli di resistenza al calpestio e alle abrasioni. Questo lo rende utilizzabile sia per le pavimentazioni ad altissimo calpestio, come gli ingressi degli aeroporti, sia per quelle di casa.

. Non si deforma, non gela e non risente degli sbalzi di temperatura.

. Non trattiene lo sporco ed è facile da pulire.

. Essendo prodotto con minimo 40% di materiale riciclato e non presentando fenomeni di cessione o dispersione nell'aria di materie tossiche, lo rendono materiale attento all'ambiente.

Very fine coloured powders, compacted with large hydraulic presses and vitrified through firing at 1250°C, give life to **SICHENIA 14mm** porcelain stoneware with 14mm thickness. Our production process makes **SICHENIA 14mm** three times more resistant when compared to traditional 10mm tiles.

. **SICHENIA 14mm** has a tensile strength of 600kg compared to the 200 kg of traditional 10 mm stoneware and has high levels of resistance to foot traffic, wear and abrasion. This means that **SICHENIA 14mm** can be used in homes but also in high traffic areas such as airports.

. It does not deform, is resistant to subzero temperatures and is unaffected by temperature changes

. It does not retain dirt and it is easy to clean

. It is produced with a minimum of 40% recycled material and does not present phenomena of dispersion of toxic materials into the air. This characteristic makes it an environmentally friendly material.

Des poudres très fines de couleur, compactées avec de grandes presses hydrauliques et vitrifiées par cuisson à 1250 ° C, donnent vie au **SICHENIA 14mm**, grès cérame de 14 mm d'épaisseur. Notre processus de production permet au **SICHENIA 14mm** d'être trois fois plus résistant que le traditionnel 10 mm.

. **SICHENIA 14mm** a une charge de rupture de 600 kg contre 200 kg pour le grès de 10 mm et présente des niveaux élevés de résistance au piétinement et à l'abrasion. Cela le rend utilisable à la fois pour les étages à très fort trafic, tels que les entrées d'aéroport, et pour le privé.

. Il ne se déforme pas, ne gèle pas et n'est pas affecté par les changements brusques de température.

. Il ne retient pas la saleté et est facile à nettoyer.

. Étant produit avec un minimum de 40% de matière recyclée, ne présentant pas de phénomènes de transfert ou de dispersion dans l'air de matières toxiques, il devient donc un matériau respectueux de l'environnement.

Sehr fein gefärbte Pulver, die mit großen Hydraulikpressen verdichtet und durch Brennen bei 1250 ° C verglast werden, geben **SICHENIA 14mm** dickem Feinsteinzeug, Leben. Unser Produktionsprozess ermöglicht es **SICHENIA 14mm**, dreimal stärker als die herkömmlichen 10 mm zu sein.

. **SICHENIA 14mm** hat eine Bruchlast von 600 kg. Im Vergleich dazu 10mm starkes Feinsteinzeug nur 200 kg. Ebenso eine hohe Beständigkeit gegen Trampeln und Abrieb. Dies macht es sowohl für sehr stark frequentierte Bereiche wie Flughafeneingänge als auch für Privathaushalte geeignet.

. Es verformt sich nicht, gefriert nicht und wird nicht durch plötzliche Temperaturwechsel beeinträchtigt.

. Es nimmt keinen Schmutz auf und ist leicht zu reinigen.

. Da es mit mindestens 40% recyceltem Material hergestellt wird und keine Ausdünstung oder Dispersion toxischer Materialien in die Luft aufweist, ist es ein umweltfreundliches Material.

Colore, serie e dimensione sono personalizzati sulla base dei limiti della capacità produttiva e del minimo d'ordine pattuito.

Color, pattern and dimension are customized within the manufacturing capability limits and based on a minimum order quantity.

La couleur, le motif et la dimension seront personnalisés dans les limites d'une compatibilité de fabrication et basés sur une quantité minimum de commande.

Farbe, Muster und Abmessungen werden im Rahmen der Fertigungsmöglichkeiten und basierend auf einer Mindestbestellmenge angepasst.

267

20 mm. SU OGNI FONDO E PER OGNI ESIGENZA SEMPRE IL MASSIMO RISULTATO.

20 mm. SUITABLE ON ANY BASE AND FOR ALL REQUIREMENTS, OFFERING MAXIMUM RESULTS.
 20 mm. SUR TOUTE SOUS-COUCHE ET TOUTE EXIGENCE, TOUJOURS LES MEILLEURS RÉSULTATS.
 20 mm. AUF JEDEM UNTERGRUND UND BEI ALLEN ERFORDERNISSEN STETS DAS HÖCHSTE ERGEBNIS.



4.

268

6.
pag. 3335.
pag. 333

3.



1.



2.

Le lastre con spessore 20 mm nascono appositamente per risolvere le problematiche di arredo degli spazi esterni.

L'alto spessore consente una maggiore versatilità di posa senza l'utilizzo di collanti. Diventa quindi la soluzione perfetta per tutti gli ambienti in esterno con fondi in terra, ghiaia o sabbia.

La posa a colla con metodo tradizionale permette di ottenere superfici estremamente resistenti ideali per spazi soggetti al passaggio e allo stazionamento di auto-veicoli. Inoltre le lastre Sichenia di 20 mm possono integrarsi con i sistemi di supporti per consentire di creare pavimentazioni sopraelevate capaci di alloggiare impianti.

The 20 mm thick slabs are designed to solve exterior design problems.

The high thickness offers greater laying versatility without the use of adhesives. It is therefore the ideal solution for exterior surfaces made of earth, gravel or sand.

With the conventional laying system using adhesive, it is possible to obtain extremely resistant surfaces, ideal for spaces subjected to vehicle traffic or parking. Sichenia's 20 mm thick slabs can also be used with support systems to create raised floors suitable to house cabling and piping.

Les dalles d'une épaisseur de 20 mm sont spécialement conçues pour résoudre les problèmes de la décoration des espaces extérieurs.

La grande épaisseur permet une meilleure polyvalence de pose sans l'utilisation de colles. Elle devient donc la solution parfaite pour tous les espaces extérieurs avec des substrats de terre, de gravier ou de sable.

La pose avec de la colle suivant la méthode traditionnelle permet d'obtenir des surfaces extrêmement résistantes, parfaites pour les espaces de passage et de stationnement de véhicules. En outre, les dalles Sichenia de 20 mm peuvent être intégrées aux systèmes de support pour permettre de créer des dallages surélevés capables de contenir des installations.

Die Platten mit einer Stärke von 20 mm wurden eigens entworfen, um Einrichtungsprobleme von Außenflächen zu lösen.

Die hohe Stärke ermöglicht eine größere Vielseitigkeit bei der Verlegung ohne Verwendung von Klebern. Sie stellen somit eine perfekte Lösung für alle Außenflächen mit Untergründen aus Erde, Kies und Sand dar.

Bei Verlegung mit der traditionellen Methode unter Einsatz von Klebern werden äußerst widerstandsfähige Flächen erzielt, die sich besonders gut für Böden eignen, die mit Fahrzeugen befahren und auf denen Fahrzeuge abgestellt werden. Außerdem können die 20 mm-Platten von Sichenia mit Stützsyste-men zur Schaffung von Doppelböden, mit Unterbringung von Anlagen, kombiniert werden.



1



2

POSA SU MASSETTO. Per applicazioni carrabili o sottoposte a sollecitazioni eccezionali procedere alla posa del materiale incollandolo su massetto cementizio. Lasciare fuga minima di 2 mm e rispettare i giunti di dilatazione.

Installation on screed. For surfaces that will be used by vehicles or subject to very high stress, install the material by bonding it to cement screed. Leave a tile gap at least 2 mm and respect expansion joints.

Pose sur chape. Pour des applications pour véhicules ou soumises à des sollicitations exceptionnelles, poser le matériau en le collant sur une chape de ciment. Laisser des joints de 2 mm au moins et respecter les joints de dilatation.

Verlegung auf Estrich. Für befahrbaren oder außergewöhnlichen Belastungen ausgesetzte Anwendungen die Verlegung des Materials vornehmen, indem man es auf Zementestrich anklebt. Fugen von mindestens 2 mm lassen und die Dehnungsfugen einhalten.



3



4

POSA SOPRAELEVATA SU SOLAI. La posa sopraelevata su solai piani consente di realizzare pavimentazioni galleggianti su supporti distanziatori fissi, con regolazione manuale o con testina mobile. Grazie ai supporti di sopraelevazione si possono realizzare pavimenti con intercapedini di differenti altezze che garantiscono la ventilazione degli strati inferiori, l'assenza di muffe e umidità residua e una facile disposizione, manutenzione e modifica degli impianti.

Raised installation on roofs. With raised installation on flat, floating pavement can be built on fixed spacing supports, which can be adjusted manually or with a height adjuster. Thanks to the raised supports, pavements can be built with gaps at different heights that provide ventilation to the lower layers, thus preventing mold and residual moisture, and enable the pavement system to be arranged, maintained and modified with ease.

Pose surélevée sur toits. La pose surélevée sur toits plats permet de réaliser de revêtements de sol flottants sur des supports de séparation fixes, avec réglage manuel ou tête mobile. Grâce aux supports surélevée, des revêtements de sol avec des espaces de différentes hauteurs peuvent être réalisés, pour garantir la ventilation des couches inférieures, l'absence de moisissures et d'humidité résiduelle ainsi qu'une mise en place, un entretien et une modification faciles des installations.

Verlegung als Doppelboden auf Flächen. Ein überhöhtes Verlegen auf ebenen Zwischenböden ermöglicht einen schwimmenden Bodenbelag auf festen, einstellbaren Distanzstücken mit manueller Einstellung oder mit mobilem Kopf. Dank den Untergrundplatten können Böden mit unterschiedlich hohen Hohlräumen eingerichtet werden, in denen die unteren Schichten belüftet werden, wodurch Schimmel und Restfeuchte vermieden und ein leichtes Verlegen, Warten und Ändern der Anlagen gewährleistet werden.

POSA A SECCO SU GHIAIA O SABBIA. La posa a secco su ghiaia consente una facile applicazione sia su terreno che su solai piani di copertura. La posa è consigliata con l'utilizzo di ghiaia o sabbia con granulometria mista compresa tra 0,5 e 8 mm.

Dry installation on gravel or sand. Dry installation on gravel is simple on both the ground and on flat supports. We recommend using gravel or sand with a mixed granulometry of 0.5 to 8 mm.

Pose à sec sur gravier ou sable. La pose à sec sur gravier permet une application facile au sol et sur des toits des terrasses planes. Il est conseillé d'utiliser du gravier ou du sable d'une granulométrie mixte comprise entre 0.5 et 8 mm.

Verlegen auf Trockenem Kies oder Sand. Das Verlegen auf trockenem Kies ermöglicht eine leichte Anwendung Böden und ebenen Zwischenböden. Wird die Verwendung von Kies oder Sand mit mittlerer Korngröße zwischen 0,5 und 8 mm empfohlen.

POSA SU ERBA. La posa a secco su erba consente la realizzazione di camminamenti ed aree in grado di integrarsi sia con il verde circostante che con differenti contesti architettonici. Le destinazioni d'uso ideali sono i giardini, i vialetti ed i camminamenti residenziali ma anche quelli di parchi e spazi ricreativi pubblici.

Laying on grass. Dry laying on grass allows the creation of paths and areas that integrate well both with the surrounding landscaping and a variety of architectural contexts. Used in this way, it is ideal not only for the gardens and paths of homes and residential complexes, but also for those of larger private and public parks and leisure areas.

Pose sur l'herbe. La pose à sec sur l'herbe permet la réalisation de sentiers et de zones s'accordant parfaitement aussi bien avec le vert environnant qu'avec de différents contextes architecturaux. Les domaines d'application idéaux sont les jardins, les allées et les sentiers résidentiels, mais également les parcs et espaces publics récréatifs.

Verlegung auf Gras. Die Trockenverlegung auf Gras ermöglicht das Anlegen von Trittsteinwegen und Flächen, die sich harmonisch in das umgebende Grün und das bauliche Umfeld einfügen. Ideale Anwendungsbereiche sind Gärten, Gehwege und Trittsteinwege in Wohnbereichen, Parks und Freizeitanlagen.

269

LE CARATTERISTICHE TECNICHE

VOCI DI CAPITOLATO

Gres porcellanato a sezione piena ed omogeneo, greificato in tutto spessore. Il materiale deve essere prodotto da un impasto di quarz, feldspati, argille e caolini, pressato (450 kg/cm²) smaltato e quindi sintetizzato a 1200 °C.

I materiali ottenuti attraverso tale procedimento appartengono al gruppo Bla (UNI EN 14411 all. G) ossia "completamente greificati" e debbono garantire la rispondenza alle norme internazionali di determinazione UNI EN ISO secondo i seguenti valori medi:

lunghezza, larghezza, rettilinearità degli spigoli, ortogonalità, planarità: +/- 0,2% (UNI EN ISO 10545.2);

assorbimento massimo: < 0,5% (UNI EN ISO 10545.3);

resistenza alla flessione: ≥ 35 N/mm² (UNI EN ISO 10545.4).

Tutta la produzione deve essere certificata antimacchia classe 5 secondo i valori ISO 10545.1 e avere la certificazione anche alla resistenza degli attacchi chimici (UNI EN ISO 10545.13) e al gelo (UNI EN ISO 10545.12).

ASSORBIMENTO D'ACQUA ISO 10545/3
La capacità di un materiale ceramico di assorbire acqua è in relazione alla sua porosità. I prodotti Sichenia, grazie alle materie prime molto pregiate e alle avanzate tecnologie produttive, offrono sempre una compattezza eccezionale e conseguentemente valori minimi di porosità. Il valore esprime la percentuale di assorbimento riferito alla massa.

RESISTENZA ALLA FLESSIONE ISO 10545/4
Corrisponde alla massima tensione che un provino del materiale stesso, sottoposto ad una crescente sollecitazione e con procedure definite, può sopportare prima di rompersi. Più alta è la compattezza e più basso è l'assorbimento d'acqua, maggiore sarà il valore richiesto per arrivare alla rottura della piastrella. È importante sottolineare che il carico di rottura della singola piastrella, misurato secondo la norma EN ISO 10545/4 e generalmente assai inferiore alla reale capacità di carico della stessa piastrella in esercizio, una volta inserita nel pavimento. Si può dimostrare, mediante calcoli e modelli matematici, che la capacità di carico della piastrella posata è superiore anche di alcune decine di volte, al carico che provoca la rottura, durante la prova di resistenza alla flessione in laboratorio, della piastrella singola svincolata dal piano di posa. Questa conclusione è peraltro intuitiva, tenendo conto della collaborazione alla resistenza alle sollecitazioni meccaniche, che la piastrella riceve dagli strati (struttura portante) ad essa stabilmente collegati.

RESISTENZA ALL'ABRASIONE SUPERFICIALE ISO 10545/7
Le superfici smaltate (GL) sono testate secondo il metodo PEI che valuta l'al-terazione della superficie dopo una serie di cicli abrasivi effettuati con l'apposita attrezzatura. Abrasione visibile a:
PEI 0 = 100 giri
PEI I = 150 giri
PEI II = 600 giri
PEI III = 750 o 1.500 giri
PEI IV = 2.100, 6.000 o 12.000 giri
PEI V = Maggiore di 12.000 giri

RESISTENZA ALL'ABRASIONE PROFONDA ISO 10545/6
Le superfici non smaltate (UGL) sono sottoposte al metodo dell'abrasione profonda; questo test determina il volume di materiale che viene asportato dalla superficie con un disco abrasivo dopo 150 giri. Tanto minore è il volume asportato tanto più resistente è il materiale.

RESISTENZA AGLI ACIDI E ALLE BASI ISO 10545/13
Il metodo determina la resistenza chimica di piastrelle sia smaltate che non smaltate, utilizzando acidi (cloridrico, citrico, lattico) e basi (idrossido di potassio) a bassa (L) e ad alta (H) concentrazione.
La cvlclassificazione viene effettuata come segue:
LA, HA: Resistente;
LB, HB: Modifica dell'aspetto della superficie;
LC, HC: Perdita parziale o completa della superficie originale.

RESISTENZA ALLE MACCHIE ISO 10545/14
Il metodo di prova prevede l'applicazione di sostanze macchianti (ossido di cromo, ossido di ferro tintura di iodio, olio d'oliva) e la successiva pulizia in sequenza con detergenti normalizzati via via più efficaci (acqua calda a 55 °C, detersivo non abrasivo, detersivo con abrasivo, solventi). Eseguito il test la classificazione prevede cinque classi, che vanno dalla 5, la più facile da pulire, alla 2, la più difficoltosa. La classe 1 indica che la macchia non è stata tolta.

270

RESISTENZA AGLI SBALZI TERMICI ISO 10545/9
Sbalzi termici sono le brusche e repentine variazioni di temperatura che sulle piastrelle che rivestono pavimenti e pareti possono verificarsi per contatto, casuale o intenzionale, con corpi caldi o freddi (ad esempio, per caduta di un liquido bollente, per pulizia con macchine a vapore, oppure nel caso di pavimenti o rivestimenti esterni, per improvvise variazioni meteorologiche, ecc.). La resistenza agli sbalzi termici è la caratteristica per la quale le piastrelle sono in grado di sopportare tali eventi senza danneggiarsi. Il procedimento (specificato nella norma EN ISO 10545/9) consiste nel fare subire alle piastrelle di prova 10 cicli termici tra la temperatura dell'acqua fredda ed una temperatura leggermente superiore a quella dell'acqua bollente, generalmente tra 15 °C e 145 °C. Dopo 5 minuti a bassa temperatura, i campioni devono essere collocati in stufa a 145 °C per circa 20 minuti e quindi riportati alle condizioni di bassa temperatura. Al termine dei 10 cicli previsti, i campioni vengono esaminati visivamente per individuare eventuali difetti.

RESISTENZA AL GELO ISO 10545/12
I materiali ceramici posati in esterno subiscono danneggiamenti dovuti al gelo se possiedono una certa porosità. Quando l'acqua eventualmente assorbita ghiaccia, aumenta il proprio volume determinando forti sollecitazioni meccaniche interne che possono tradursi in distacchi di materiale sulla superficie. Le mattonelle Sichenia sono ingelive quando, in virtù della porosità quasi nulla, superano sempre il test ISO 10545-12 che prevede 100 cicli gelo/disgelo tra -5°C e +5°C senza subire nessun danno.

RESISTENZA ALLO SCIVOLAMENTO
È il parametro utilizzato per caratterizzare la scivolosità di una superficie. Tanto più è alto il coefficiente di attrito tanto minore è la scivolosità. Nel caso dei pavimenti appare evidente come la scivolosità sia legata alla sicurezza della deambulazione, soprattutto per le piastrelle destinate a pavimenti di particolari ambienti esterni, pubblici ed industriali. Per quanto concerne la natura delle superfici, è logico che il coefficiente di attrito è tanto più basso quanto più la superficie è liscia per diventare più elevato in presenza di superfici scabre e rugose. Va rilevato che quest'ultime superfici che rendono ottimali le condizioni di sicurezza in relazione alla prevenzione dello scivolamento, sono tali da rendere invece maggiormente difficili le operazioni di pulizia. È un fatto importante, del quale occorre tenere conto in fase di scelta del materiale da pavimento. Attualmente i metodi più utilizzati per la determinazione del grado di scivolosità nelle pavimentazioni sono sostanzialmente 6:

Metodo inglese **B.C.R.A. Rep CEC/81**
Metodo tedesco **DIN EN 16165: 2023 Annex B** (con calzature); **Annex A** (a piedi nudi)
Metodo americano **ANSI A326.3**
Metodo del Pendolo australiano **AS/NZS 4586**
Metodo del Pendolo inglese **BS EN 16165: 2021 Annex C**
Metodo del Pendolo Spagnolo **UNE-ENV 12633**
La legislazione italiana riconosce il metodo BCR tortus per valutare la scivolosità dei pavimenti sottoposti ai vincoli di sicurezza imposti dal D.M. N° 236 del 14.06.89 in materia di abbattimento delle barriere architettoniche per portatori di handicap.
BB.C.R.A. Rep CEC/81
Metodo di derivazione inglese che misura il coefficiente di attrito mediante un dispositivo mobile portatile; dotato di un motore elettrico si muove a velocità costante sulla superficie delle piastrelle da provare. Si determina il coefficiente d'attrito che si esercita fra la piastrella e l'elemento scivolante di contatto, rivestito sia di cuoio che gomma standardizzati, in condizioni di asciutto e poi di bagnato. Questo metodo può essere impiegato sia in laboratorio che sul campo. I risultati vengono valutati secondo la seguente classificazione:
Inferiore a 0,19 scivolosità pericolosa
da 0,20 a 0,39 scivolosità eccessiva
da 0,40 a 0,74 attrito soddisfacente
superiore a 0,75 attrito eccellente

DIN EN 16165: 2023 Annex B (con calzature): **Annex A** (a piedi nudi)
Il metodo è quello del piano inclinato, dove una persona cammina avanti e indietro su una piattaforma rivestita di piastrelle ceramiche. L'inclinazione dell'area di prova viene aumentata con velocità costante fino all'angolo in cui la persona mostra insicurezza nella deambulazione (cioè inizia a scivolare). A questo punto si interrompe la prova e si registra l'angolo di inclinazione della piattaforma a cui corrisponde una classificazione (R per pavimenti asciutti, A per pavimenti bagnati). La prova viene effettuata indossando calzature normalizzate e applicando sulle piastrelle in esame, olio con caratteristiche standard in un caso, e nell'altro a piedi scalzi su pavimenti ceramici in presenza di acqua. Questa prova può essere effettuata solo in laboratorio e non sul campo. I risultati vengono valutati secondo lo schema sotto riportato:
DIN 51130 (scarpe + olio) **DIN 51097** (piedi nudi + acqua)
da 6° fino a 10° R 9 0
oltre 10° fino a 19° R 10 da 12° a 17,9° A
oltre 19° fino a 27° R 11 da 18° a 23,9° B
oltre 27° fino a 35° R 12 oltre 23,9° C
oltre 35° R 13

R 9 Zone d'ingresso e scale con accesso dall'esterno; ristoranti e mense; negozi; ambulatori, ospedali, scuole.
R 10 Bagni e doccie comuni; piccole cucine di esercizi per la ristorazione; garage sotterranei.
R 11 Ambienti per la produzione di generi alimentari; medie cucine di esercizi per la ristorazione; con volumi al di sotto di 100 coperti; ambienti di lavoro con forte presenza di acqua e fanghiglia; lavanderie, laboratori, hangar.
R 12 Ambienti per la produzione di alimentari ricchi in grassi, come: formaggi, burro, olii, gelati, salumi; grandi cucine di esercizi per la ristorazione con volumi superiori ai 100 coperti, reparti industriali con impiego di sostanze scivolose: vernici, fanghi, colle liquide; parcheggi di auto.
R13 Ambienti con grosse quantità di grassi; lavorazioni della carne, del pesce, e delle verdure; conerie.
Per indicazioni più precise e dettagliate si rimanda all'opuscolo informativo edito dal comitato tecnico tedesco per la prevenzione degli infortuni e medicina del lavoro: Alte Heerstrasse 111, 53754, ST. AUGUSTIN Comitato tecnico "struttura edilizia" pavimenti n° ordine: ZH 1/571 edizione luglio 93.

ANSI A326.3
Coefficiente dinamico di attrito (DCOF): a volte chiamato coefficiente d'attrito. Questo è il rapporto tra la forza necessaria a mantenere una superficie già in movimento di scorrimento su un'altra diviso per il peso (o forza normale) di un oggetto. Questa forza è una proprietà dei materiali delle due superfici. DCOF è solitamente inferiore a SCOF per gli stessi materiali. Contaminanti quali sporcizia, acqua, sapone, olio o grasso possono modificare questo valore. Se non diversamente specificato, piastrelle adatte per spazi interni che dovrebbero essere calpestati quando è bagnato devono avere un DCOF umido di 0,42 o superiore durante il test con la soluzione di SLS. Tuttavia, le piastrelle con una DCOF di 0,42 o superiore non sono necessariamente adatte per tutti i progetti. Identificatore stabilisce piastrelle idonee per un progetto specifico, considerando a titolo di esempio, ma non in limitazione, tipo di impiego, traffico pedonale, contaminanti, manutenzione e le linee guida e le raccomandazioni dei produttori.

AS/NZS 4586 – APPENDICE A
La prova del pendolo bagnato per la misurazione della resistenza allo scivolamento (AS/NZS 4586 Appendice A) è generalmente eseguita utilizzando uno strumento di prova a pendolo Wessex oppure Munro - Stanley London. Il dispositivo a pendolo è portatile ed è composto da un piede appesantito e da un cursore di prova che oscilla verso il basso e scorre su una superficie bagnata con acqua. Il piede comprende un cursore in gomma con carica a molla che esercita una forza prestabilita sul campione adeguato. Si utilizza prevalentemente gomma TRL (Transport Research Laboratory) per superfici ad alta resistenza allo scivolamento secondo la norma AS/NZS 4586, come indicato nella tabella seguente. La AS/NZS 4586 classifica la superficie sulla base del valore BPN medio, mentre la norma australiana per prove di resistenza allo scivolamento AS/NZS 4663 esprime l'esito come BPN. La AS/NZS 4663 fornisce inoltre una stima del contributo teorico del pavimento al rischio di scivolamento in presenza di acqua, come indicato di seguito:

Valore medio per prova a pendolo BPM	Classificazione AS/ NZS 4586	AS/NZS 4663 Contributo teorico del pavimento al rischio di scivolamento sul bagnato	
Flour S	TRL		
>54	>44	V (P5:2013)	Molto Basso
45-54	40-44	W (P4:2013)	Basso
35-45		X (P3:2013)	Moderato
25-34		Y (P2:2013)	Alto
<25		Z (P1:2013)	Molto Alto

Mentre si possono utilizzare 2 tipi di materiale per il cursore in gomma, la suola da scarpa simulata standard ('Four S') è generalmente accettata come materiale per valutare la resistenza allo scivolamento per persone che indossano calzature adeguate. Si utilizza prevalentemente gomma TRL (Transport Research Laboratory) per superfici ad alta resistenza allo scivolamento o superfici strutturate. Le attività di ricerca hanno dimostrato che la gomma TRL fornisce un'indicazione più affidabile della resistenza allo scivolamento a piedi nudi, data la natura più morbida e cedevole del materiale che è più simile alla pelle umana rispetto alla gomma Four S.

BS EN 16165: 2021 Annex C
Questa norma inglese "Pendulum Testers" edita nel 2002 è suddivisa in tre parti (Specification - Method of operation -Method of calibration), prevede la misura della resistenza allo scivolamento attraverso l'impiego di un dispositivo a pendolo: l'elemento scivolante rivestito con gomma e collegato al braccio di un pendolo descritto nella parte 1 della norma, viene fatto "strisciare" sulla superficie da provare dopo averlo lasciato cadere da un'altezza predefinita; la sua corsa viene tanto più rallentata, quanto più elevato è l'attrito offerto dalla superficie. In altre parole: alla posizione iniziale è associato un valore di energia potenziale, che in assenza di ostacoli permetterebbe all'elemento scivolante di risalire dalla parte opposta fino ad un'altezza uguale a quella di partenza. Il passaggio sulla superficie di prova assorbe parte dell'energia e l'elemento scivolante risale fino ad un'altezza inferiore; su una scala opportunamente graduata vengono letti i valori del cosiddetto PTV (Test Pendulum Value) tanto più elevati quanto minore è la scivolosità del campione provato. Il risultato viene diviso in tre classi di scivolosità:

Elevato potenziale di scivolamento 0-24

Moderato potenziale di scivolamento 25-35

Basso potenziale di scivolamento 36 +

UNE ENV 12633
Prova del pendolo secondo la normativa UNE ENV 12633
CLASSIFICAZIONE DEI PAVIMENTI:

Scivolosità (R _a)	Classe
R _a ≤15	0
15<R _a ≤35	1
35<R _a ≤45	2
R _a >45	3
Classe attribuibile alle pavimentazioni in funzione della loro collocazione	
Collocazione e caratteristiche della pavimentazione	Classe
Zone interne asciutte	
- superfici con pendenza minore del 6%	1
- superfici con pendenza maggiore o uguale al 6% e scale	2
Zone interne umide, come gli ingressi agli edifici da spazi esterni (1), terrazze coperte, guardaroba, docce, bagni, spogliatoi, cucine, etc.	
- superfici con pendenza minore del 6%	2
- superfici con pendenza maggiore o uguale al 6% e scale	3
Zone interne dove, oltre l'acqua, si possono trovare agenti (grassi, lubrificanti, etc.) che riducono la resistenza allo scivolamento, come cucine industriali, macelli, parcheggi, zone di uso industriale, ecc.	
Zone esterne. Piscine (2)	3

(1) Fanno eccezione gli accessi diretti a zone di uso limitato.
(2) In zone dove si prevede il passaggio di utenti scalzi e sul fondo delle vasche nella zona in cui la profondità non ecceda 1,50 m.

TECHNICAL PROPERTIES

TENDER SPECIFICATIONS
Glazed porcelain stoneware, with a solid, uniform section vitrified throughout the body. The material must be produced from a paste containing quartz, feldspars, clay and kaolin, which is pressed (450 kg/cm²), glazed and then sintered at 1200 °C.

The materials obtained with the said procedure belong to the Bla group (UNI EN 14411 annex G),in other words they are "fully vitrified" and comply with UNI EN ISO international standards as regards the following average values:

length, width, corner straightness, orthogonality, flatness: +/- 0.2% (UNI EN ISO 10545.2);

max absorption; < 0.5% (UNI EN ISO 10545.3);

bending strength: ≥ 35 N/mm² (UNI EN ISO 10545.4).

All the production must be certified as stain proof class 5 according to the ISO 10545.1 values and also as resistant to chemical attacks (UNI EN ISO 10545.13) and frost (UNI EN ISO 10545.12).

WATER ABSORPTION ISO 10545/3
A ceramic material's capacity to absorb water depends on its porosity. Thanks to the choice quality raw materials used and the state-of-the-art production technologies, Sichenia products are always outstandingly compact, meaning that their porosity values are minimal. The value expresses the percentage water absorption by weight.

BENDING STRENGTH ISO 10545/4
This corresponds to the maximum tension that a specimen of the material can withstand before breaking, when subjected to constant increasing stress according to defined procedures. The higher the compactness, the lower the water absorption and the greater the value required to break the tile. It is important to underline that the breaking load of a single tile, measured according to the EN ISO 10545/4 standard is generally much lower than the real load capacity of that same tile once installed on the floor. It can be shown, by means of calculations and mathematical models, that the load capacity of a fitted tile is superior even by a few dozen times, to the load that causes the rupture, during the bending resistance test in the laboratory, of the single tile when it is not installed. This conclusion is logical considering that the tile's resistance to mechanical stress is enhanced by the layers (bearing structure) on which it is installed.

RESISTANCE TO SURFACE ABRASION ISO 10545/7
Glazed (GL) surfaces are tested using the PEI method which assesses the change in the surface after a series of abrasive revolution cycles performed with special equipment.
Visible abrasion at:

PEI 0 = 100 rotations
PEI I = 150 rotations
PEI II = 600 rotations
PEI III = 750 or 1.500 rotations
PEI IV = 2.100, 6.000 or 12.000 rotations
PEI V = Morer than 12.000 rotations

DEEP ABRASION RESISTANCE ISO 10545/6
Unglazed (UGL) surfaces are subjected to the deep abrasion method; this test measures the value of material removed from the surface with an abrasive disc after 150 rotations cycles. The lower the volume removed, the more resistant the material.

RESISTANCE TO ACIDS AND BASES ISO 10545/13
The method measures the chemical resistance of both glazed and unglazed tiles, using acids (hydrochloric, citric and lactic) and bases (potassium hydroxide) at low (L) and high (H) concentration.
The classification is as follows:
LA, HA: Resistant;
LB, HB: Changes in appearance of surface;
LC, HC: partial or complete loss of original surface.

STAIN RESISTANCE ISO 10545/14
The testing method consists in applying staining agents (chromium oxide, iron oxide, iodine tincture and olive oil) on the surface and then cleaning it following a sequence, with increasingly efficient standardised detergents (hot water at 55°, non abrasive detergent, detergent with abrasive and solvents). After the test, the classification foreses five classes, from 5, the easiest to clean, to 2, the hardest to clean. Class 1 means that the stain could not be removed.

THERMAL SHOCK RESISTANCE ISO 10545/9
Thermal shock means abrupt and sudden temperature changes that affect the floor and wall tile coverings through the accidental or intentional contact with hot or cold elements (for example falling hot liquid, cleaning with steam machines, or sudden weather changes in the case of exterior floor and wall coverings, etc.). The resistance to sudden temperature changes determines the resistance of tiles to these events without being damaged. The process (specified in the EN ISO 10545/9 standards) subjects tiles to the test of 10 thermal cycles at temperatures that go from the temperature of cold water to a temperature slightly higher than that of boiling water, generally between 15° C and 145° C. After 5 minutes at low temperature, the samples are placed in an oven at 145° C for about 20 minutes then they are placed once again in low temperature conditions. After the 10 cycles, the samples are visually examined to check for any defects.

FROST RESISTANCE ISO 10545/12
Ceramic materials laid outdoors suffer frost damage if their porosity is above a certain level. When any water absorbed freezes, it increases in volume, generating strong internal mechanical stresses which may cause the material to detach from the underlying surface. Sichenia tiles are frostproof because, thanks to their porosity value of virtually nil, they always pass the ISO 10545-12 test comprising 100 freeze/thaw cycles between -5°C and +5°C without suffering any damage.

SLIPRESISTANCE
This is the paramter adopted to measure the slipperiness of a surface. The higher the coefficient of friction, the less slippery is the surface. In the case of floors, slipperiness is obviously linked to safe walking, especially for tiles intended for particular external, public and industrial environments. As regards the nature of the surfaces, it is logical that the smoother the surface, the lower the coefficient of friction; the coefficient of friction is higher in the case of a rough surface. Rough surfaces offer optimal safety in terms of slipping prevention, but they are much more difficult to clean. This is an important aspect to take into account when choosing floor tiles. Currently there are 6 main methods used to define the level of slipperiness of floors:

English method **B.C.R.A. Rep CEC/81**
German method **DIN EN 16165: 2023 Annex B** (with footwear); **Annex A** (bare feet)
American method **ASTM C 1028**
Australian Pendulum method **AS/NZS 4586**
British Pendulum method **BS EN 16165: 2021 Annex C**
Spanish Pendulum method **UNE-ENV 12633**
Italian legislation acknowledges the BCR tortus method to assess the slipperiness of floors subject to safety constraints imposed by Ministerial Decree no. 236 of 14.06.89 on the elimination of architectural barriers for the disabled.

B.C.R.A. Rep CEC/81
English testing method that measures the friction coefficient using a portable device; the device is fitted with an electric motor and moves at constant speed on the surface of the tiles to be tested. It determines the coefficient of friction which is exercised between the tile and the sliding element of contact, covered with standard leather and rubber, in dry and then wet conditions. This method can be adopted in the laboratory and on site. The results are classified as follows:
Lower than 0,19 dangerous slipperiness
from 0,20 to 0,39 excessive slipperiness
from 0,40 to 0,74 satisfactory friction
higher than 0,75 excellent friction

DIN EN 16165: 2023 Annex B (with footwear); **Annex A** (bare feet)

This is the method of the inclined surface, where a person walks up and down on a sloping platform covered with tiles. The tilt of the test area is increased at constant speed until it reaches an angle where the person starts becoming unsafe while walking (i.e. starts slipping). At this point, the test is interrupted and the platform tilt angle is recorded, which corresponds to a classification (R for dry floors, A for wet floors). The test is carried out in one case wearing standard footwear and applying standard oil on the tiles and in the other barefooted on floor tiles that are wet with water. This test can only be carried out in a laboratory, not on site. The results are classified as shown below:

DIN 51130 (footwear + oil) **DIN 51097** (bare feet + water)
from 6° to 10° R 9 < 12° 0
over 10° to 19° R 10 from 12° to 17,9° A
over 19° to 27° R 11 from 18° to 23,9° B
over 27° to 35° R 12 over 23,9° C
over 35° R 13

R 9 Halls and stairs with access from the outside; restaurant and canteens; shops, clinics, hospitals, schools.
R 10 Common bathrooms and showers, little kitchens of refreshment premises, underground car-parks.
R 11 Areas where food-stuffs are prepared, in kitchens of refreshment premises with less than 100 seats. Working areas with a lot of water and mud; laundries, laboratories, hangars.
R 12 Areas where food-stuffs rich in fat are prepared, such as: cheese, butter, oils, ice-creams, sausages; big kitchens of refreshment premises with more than 100 seats; industrial department where slippery substances are used: paints, muds, liquid glues; car-parks.
R 13 Areas with great quantities of fat, e.g. where meat, fish, vegetable are processed; tanneries. For further and more precise information, refer to the information pamphlet issued by the German technical Committee for accident preventing and industrial medicine: ALTE HEERSTRASSE 111, 53754 ST. AUGUSTING Floors-order n°. zh 1/571 July '93 issue.

ANSI A326.3
Dynamic Coefficient of Friction (DCOF): sometimes called kinetic coefficient of friction. This is the ratio of the force necessary to keep a surface already in motion sliding over another divided by the weight (or normal force) of an object. This force is a materials property of the two surfaces. DCOF is usually less than SCOF for the same materials. Contaminants such as dirt, water, soap, oil, or grease can change this value. Unless otherwise specified, tiles suitable for interior spaces expected to be walked upon when wet shall have a wet DCOF of 0,42 or greater when tested using SLS solution. However, tiles with a DCOF of 0,42 or greater are not necessarily suitable for all projects. The specifier shall determine tiles appropriate for specific project conditions, considering by way of example, but not in limitation, type of use, traffic, expected contaminants, expected maintenance, expected wear,2, and manufacturers' guidelines and recommendations.

AS/NZS 4586 – APPENDIX A
The wet pendulum slip resistance test (AS/NZS 4586 Appendix A) is generally conducted using a Wessex or Munro - Stanley London Pendulum Friction Tester. This pendulum device is portable and consists of a weighted foot with a test slider that swings down and slides across the surface wetted with water. The weighted foot comprises a spring loaded rubber test slider that exerts a prescribed force over the specimen as it slides across the surface. The results of expressed as a British Pendulum Number (BPN) and classified according to AS/NZS 4586 as shown in the table below:
AS/NZS 4586 classifies the surface based on the mean BPN where the Australian Standard for onsite slip testing AS/NZS 4663 expresses the result in terms of BPN. AS/NZS 4663 also provides a notional contribution of the floor surface to the risk of slipping when water wet as given below:

Pendulum mean BPM		AS/NZS 4586 Classification	AS/NZS 4663 Notional contribution of the floor surface to the risk of slipping when wet
Flour S	TRL		
>54	>44	V (P5:2013)	Very low
45-54	40-44	W (P4:2013)	Low
35-45		X (P3:2013)	Moderate
25-34		Y (P2:2013)	High
<25		Z (P1:2013)	Very higt

While there are 2 rubber slider materials that may be used, Four S (simulated standard shoe sole) is generally accepted as the method to assess the slip resistance for the general public wearing suitable footwear. TRL (Transport Research Laboratory) rubber is predominantly used for highly slip resistant and profiled surfaces. Research has indicated that TRL rubber may provide a better indication of barefoot slip resistance due to the softer yielding nature of the material, being more comparable to human skin than Four S rubber.

BS EN 16165: 2021 Annex C
The British standard "Pendulum Testers" edited in 2002, is dividedinto three parts (Specification -Method of operation - Method of calibration), and aims to measure slip potential using a pendulum device: the sliding element lined with rubber and connected to the arm of the pendulum described in part 1 of the standard is made to "slide" along the surface being tested after having been dropped from a set height; the greater the friction offered by the surface, the slower it moves. In other words: the initial position is associated to a potential energy value, which in the absence of any obstacles would allow the sliding element to climb from the opposite side to a height equal to the starting height. The passage along the tested surface absorbs part of the energy and the sliding element climbs to a lesser height; the so-called PTV (Test Pendulum Value) is read on a graded scale: the greater the value, the lower the slip potential of the tested sample. The result is divided into three slip potential classes:

High anti-slip potential 0-24

Moderate anti-slip potential 25-35

Low anti-slip potential 36+

270

UNE ENV 12633
Pendulum test according to the UNE ENV 12633 standard
CLASSIFICATION OF FLOORS:

Slip resistance coefficient (R _a)	Class
R _a ≤15	0
15<R _a ≤35	1
35<R _a ≤45	2
R _a >45	3
Class required for floors according to their location	
Location and characteristics of the floor	Class
Dry interior areas	
- surfaces with a slope less than 6%	1
- surfaces with a slope equal to or greater than 6% and stairs	2
Humid interior areas, such as entrances to buildings from the exterior (1), covered terraces, changing rooms, showers, baths, toilets, kitchens, etc.	
- surfaces with a slope less than 6%	2
- surfaces with a slope equal to or greater than 6% and stairs	3
Interior areas, which in addition to water, may include agents (greases, lubricants, etc.) that may reduce slip resistance, such as industrial kitchens, slaughterhouses, parking lots, industrial use areas, etc.	3
Exterior areas. Swimming pools (2)	3

(1) Except in the case of direct entries to areas of restricted use.
(2) In areas provided for barefoot users and in the bottom of pools, in areas in which the depth does not exceed 1,5 m.

Caratteristiche tecniche di superficie

Technical surface properties.
Caractéristiques techniques des surfaces.
Technische Eigenschaften der Oberfläche.

STONE PIETRE	Bordi Edges. Bords. Kanten.	Spessore Thickness. Épaisseur. Stärke.	Resistenza allo scivolamento Slip resistance. Résistance au glissement. Rutschfestigkeit.							Resistenza alle macchie (Pulibilità) Resistance to staining. Résistance aux produits tachants. Flecken Beständigkeit.	Resistenza agli acidi e alle basi Resistance to acids and bases. Résistance aux acides et aux bases. Beständigkeit gegen Säuren und Laugen.		
			DIN EN 16165: 2023 Annex B	DIN EN 16165: 2023 Annex A	AS/NZS 4586	BS EN 16165	UNE-ENV 12633	B.C.R.A. Rep CEC/81	DCOF Ansi A 326.3			ISO 10545/14	ISO 10545/13
			AMBOISE										
LAPPATO	Ret	9 mm	-	-	-	-	-	-	5	A . LA . HA			
SMOOTH	Ret	9 mm	R9	-	-	-	-	-	5	A . LA . HA			
SOFT GRIP	Ret	9 mm	R10	A+B	P3	≥ 36 Wet	Classe C2	> 0,40	≥ 0,42 Wet	5	A . LA . HA		
GRIP	Ret	9 mm	R11	A+B+C	P4	≥ 36 Wet	Classe C3	> 0,40	≥ 0,62 Wet	5	A . LA . HA		
GRIP	Ret	20 mm	R11	A+B+C	P4	≥ 36 Wet	Classe C3	> 0,40	≥ 0,62 Wet	5	A . LA . HA		
ARDENNES													
MATT	Ret	9 mm	R10	A+B	-	-	-	> 0,40	≥ 0,42 Wet	5	A . LA . HA		
GRIP	Ret	9 mm	R11	A+B+C	P4	≥ 36 Wet	Classe C3	> 0,40	≥ 0,62 Wet	5	A . LA . HA		
GRIP	Ret	20 mm	R11	A+B+C	P4	≥ 36 Wet	Classe C3	> 0,40	≥ 0,62 Wet	5	A . LA . HA		
AR_GENT													
MATT	Ret	9 mm	R10	A+B	P3	≥ 36 Wet	Classe C2	> 0,40	≥ 0,42 Wet	5	A . LA . HA		
GRIP	Ret	20 mm	R11	A+B+C	P4	≥ 36 Wet	Classe C3	> 0,40	≥ 0,62 Wet	5	A . LA . HA		
CHANTILLY													
NATURALE	Ret	9 mm	R9	-	-	-	-	-	-	5	A . LA . HA		
SOFT GRIP	Ret	9 mm	R10	A+B	P3	≥ 36 Wet	Classe C2	> 0,40	≥ 0,42 Wet	5	A . LA . HA		
GRIP	Ret	9 mm	R11	A+B+C	P4	≥ 36 Wet	Classe C3	> 0,40	≥ 0,62 Wet	5	A . LA . HA		
GRIP	Ret	20 mm	R11	A+B+C	P4	≥ 36 Wet	Classe C3	> 0,40	≥ 0,62 Wet	5	A . LA . HA		
CHATEAUX													
R10	Ret	9 mm	R10	A+B	-	-	-	> 0,40	≥ 0,42 Wet	5	A . LA . HA		
GRIP	Ret	9 mm	R11	A+B+C	P4	≥ 36 Wet	Classe C3	> 0,40	≥ 0,62 Wet	5	A . LA . HA		
GRIP	Ret	20 mm	R11	A+B+C	P4	≥ 36 Wet	Classe C3	> 0,40	≥ 0,62 Wet	5	A . LA . HA		
CREMA LUNA													
MATT	Ret	9 mm	R10	A+B	-	-	-	> 0,40	≥ 0,42 Wet	5	A . LA . HA		
BAMBUS MATT	Ret	9 mm	R10	A+B	-	-	-	> 0,40	≥ 0,42 Wet	5	A . LA . HA		
BOCC. SOFT GRIP	Ret	9 mm	R11	A+B	-	-	-	> 0,40	≥ 0,42 Wet	5	A . LA . HA		
TUSCIA MURETTO	Nat	10 mm	-	-	-	-	-	-	-	5	A . LA . HA		
BOCC. GRIP	Ret	20 mm	R11	A+B+C	P4	≥ 36 Wet	Classe C3	> 0,40	≥ 0,62 Wet	5	A . LA . HA		
MYSTONE													
MATT	Ret	9 mm	R10	A+B	-	-	-	> 0,40	≥ 0,42 Wet	5	A . LA . HA		
GRIP	Ret	20 mm	R11	A+B+C	P4	≥ 36 Wet	Classe C3	> 0,40	≥ 0,62 Wet	5	A . LA . HA		
PAVÉ DELLE ALPI													
SOFT GRIP	Ret	9 mm	R10	A+B	P3	≥ 36 Wet	Classe C2	> 0,40	≥ 0,42 Wet	5	A . LA . HA		
GRIP	Ret	9 mm	R11	A+B+C	P4	≥ 36 Wet	Classe C3	> 0,40	≥ 0,62 Wet	5	A . LA . HA		
MURETTO	Nat	10 mm	-	-	-	-	-	-	-	5	A . LA . HA		
GRIP	Nat	10 mm	R11	A+B+C	P4	≥ 36 Wet	Classe C3	> 0,40	≥ 0,62 Wet	5	A . LA . HA		
GRIP	Nat	14 mm	R11	A+B+C	P4	≥ 36 Wet	Classe C3	> 0,40	≥ 0,62 Wet	5	A . LA . HA		
GRIP	Ret	20 mm	R11	A+B+C	P4	≥ 36 Wet	Classe C3	> 0,40	≥ 0,62 Wet	5	A . LA . HA		
PAVÉ WALL 30.90													
VELVET	Ret	10 mm	-	-	-	-	-	-	-	5	A . LA . HA		
ROWS	Ret	10 mm	-	-	-	-	-	-	-	5	A . LA . HA		
RIBBED	Ret	10 mm	-	-	-	-	-	-	-	5	A . LA . HA		
PAVÉ WALL DOLMEN													
MURETTO	Nat	10 mm	-	-	-	-	-	-	-	5	A . LA . HA		
PAVÉ WALL HOUSE													
MURETTO	Nat	10 mm	-	-	-	-	-	-	-	5	A . LA . HA		

274

MARBLE MARMİ	Bordi Edges. Bords. Kanten.	Spessore Thickness. Épaisseur. Stärke.	Resistenza allo scivolamento Slip resistance. Résistance au glissement. Rutschfestigkeit.							Resistenza alle macchie (Pulibilità) Resistance to staining. Résistance aux produits tachants. Flecken Beständigkeit.	Resistenza agli acidi e alle basi Resistance to acids and bases. Résistance aux acides et aux bases. Beständigkeit gegen Säuren und Laugen.		
			DIN EN 16165: 2023 Annex B	DIN EN 16165: 2023 Annex A	AS/NZS 4586	BS EN 16165	UNE-ENV 12633	B.C.R.A. Rep CEC/81	DCOF Ansi A 326.3			ISO 10545/14	ISO 10545/13
			COPICO										
MATT	Ret	9 mm	R10	A+B	-	-	-	> 0,40	≥ 0,42 Wet	5	A . LA . HA		
NAVONA													
MURETTO	Ret	10 mm	-	-	-	-	-	-	-	5	A . LA . HA		
SATIN 3D	Ret	9 mm	R9	-	-	-	-	-	-	5	A . LA . HA		
BOCC. SOFT GRIP	Ret	9 mm	R11	A+B	-	-	-	> 0,40	≥ 0,42 Wet	5	A . LA . HA		
GRIP	Ret	20 mm	R11	A+B+C	P4	≥ 36 Wet	Classe C3	> 0,40	≥ 0,62 Wet	5	A . LA . HA		
PRESTIGE													
SATIN 3D	Ret	9 mm	R9	-	-	-	-	-	-	5	A . LA . HA		
LAPPATO	Ret	9 mm	-	-	-	-	-	-	-	5	A . LA . HA		

CONTEMPORARY CONTEMPORANEO	Bordi Edges. Bords. Kanten.	Spessore Thickness. Épaisseur. Stärke.	Resistenza allo scivolamento Slip resistance. Résistance au glissement. Rutschfestigkeit.							Resistenza alle macchie (Pulibilità) Resistance to staining. Résistance aux produits tachants. Flecken Beständigkeit.	Resistenza agli acidi e alle basi Resistance to acids and bases. Résistance aux acides et aux bases. Beständigkeit gegen Säuren und Laugen.		
			DIN EN 16165: 2023 Annex B	DIN EN 16165: 2023 Annex A	AS/NZS 4586	BS EN 16165	UNE-ENV 12633	B.C.R.A. Rep CEC/81	DCOF Ansi A 326.3			ISO 10545/14	ISO 10545/13
			94 EVO										
MATT	Ret	9 mm	R10	A+B	-	-	-	> 0,40	≥ 0,42 Wet	5	A . LA . HA		
GRIP	Ret	9 mm	R11	A+B+C	P4	≥ 36 Wet	Classe C3	> 0,40	≥ 0,62 Wet	5	A . LA . HA		
ART BY SICHENIA (INDUSTRIAL)													
SATIN	Ret	9 mm	-	-	-	-	-	-	-	5	A . LA . HA		
BLOCK													
R10	Ret	9 mm	R10	A+B	P3	≥ 36 Wet	Classe C2	> 0,40	≥ 0,42 Wet	5	A . LA . HA		
GRIP	Ret	9 mm	R11	A+B+C	P4	≥ 36 Wet	Classe C3	> 0,40	≥ 0,62 Wet	5	A . LA . HA		
GRIP	Ret	20 mm	R11	A+B+C	P4	≥ 36 Wet	Classe C3	> 0,40	≥ 0,62 Wet	5	A . LA . HA		
CON_CRETE3													
SATIN	Ret	9 mm	-	-	-	-	-	-	-	5	A . LA . HA		
SOFT GRIP	Ret	9 mm	R10	A+B	P3	≥ 36 Wet	Classe C2	> 0,40	≥ 0,62 Wet	5	A . LA . HA		
GRIP	Ret	9 mm	R11	A+B+C	P4	≥ 36 Wet	Classe C3	> 0,40	≥ 0,62 Wet	5	A . LA . HA		
GRIP	Ret	20 mm	R11	A+B+C	P4	≥ 36 Wet	Classe C3	> 0,40	≥ 0,62 Wet	5	A . LA . HA		
ME_TAL													
R10	Ret	9 mm	R10	A+B	P3	≥ 36 Wet	Classe C2	> 0,40	≥ 0,42 Wet	5	A . LA . HA		
PAVÉ BRICK													
R10	Nat	10 mm	R10	A	-	-	-	> 0,40	≥ 0,42 Wet	5	A . LA . HA		
GRIP	Nat	10 mm	R11	A+B+C	P4	≥ 36 Wet	Classe C3	> 0,40	≥ 0,62 Wet	5	A . LA . HA		
PROGETTO S7													
GLOSSY	Nat	10 mm	-	-	-	-	-	-	-	5	A . LA . HA		

275

Caratteristiche tecniche di superficie

Technical surface properties.
Caractéristiques techniques des surfaces.
Technische Eigenschaften der Oberfläche.

276

WOOD LEGNO	Bordi Edges. Bords. Kanten.	Spessore Thickness. Épaisseur. Stärke.	Resistenza allo scivolamento Slip resistance. Résistance au glissement. Rutschfestigkeit.							Resistenza alle macchie (Pulibilità) Resistance to staining. Résistance aux produits tachants. Flecken Beständigkeit.	Resistenza agli acidi e alle basi Resistance to acids and bases. Résistance aux acides et aux bases. Beständigkeit gegen Säuren und Laugen.		
			DIN EN 16165: 2023 Annex B	DIN EN 16165: 2023 Annex A	AS/NZS 4586	BS EN 16165	UNE-ENV 12633	B.C.R.A. Rep CEC/81	DCOF Ansi A 326.3			ISO 10545/14	ISO 10545/13
LA THUILE													
MATT	Ret	9 mm	R10	A+B	-	-	-	> 0,40	≥ 0,42 Wet	5	A . LA . HA		
P_ARKETT													
SATIN	Ret	9 mm	-	-	-	-	-	-	-	5	A . LA . HA		
SOFT GRIP	Ret	9 mm	R10	A+B	P3	≥ 36 Wet	Classe C2	> 0,40	≥ 0,42 Wet	5	A . LA . HA		
GRIP	Ret	20 mm	R11	A+B+C	P4	≥ 36 Wet	Classe C3	> 0,40	≥ 0,62 Wet	5	A . LA . HA		
SHER_WOOD													
MATT	Ret	9 mm	R10	A+B	-	-	-	> 0,40	≥ 0,42 Wet	5	A . LA . HA		
GRIP	Ret	9 mm	R11	A+B+C	P4	≥ 36 Wet	Classe C3	> 0,40	≥ 0,62 Wet	5	A . LA . HA		
GRIP	Ret	20 mm	R11	A+B+C	P4	≥ 36 Wet	Classe C3	> 0,40	≥ 0,62 Wet	5	A . LA . HA		
SILVIS													
R10	Ret	9 mm	R10	A+B	-	-	-	> 0,40	≥ 0,42 Wet	5	A . LA . HA		
GRIP	Ret	9 mm	R11	A+B+C	P4	≥ 36 Wet	Classe C3	> 0,40	≥ 0,62 Wet	5	A . LA . HA		
GRIP	Ret	20 mm	R11	A+B+C	P4	≥ 36 Wet	Classe C3	> 0,40	≥ 0,62 Wet	5	A . LA . HA		
TRONÇAIS													
MATT	Ret	9 mm	R10	A+B	-	-	-	> 0,40	≥ 0,42 Wet	5	A . LA . HA		
GRIP	Ret	9 mm	R11	A+B+C	P4	≥ 36 Wet	Classe C3	> 0,40	≥ 0,62 Wet	5	A . LA . HA		

14MM . 20MM SPESSORATI	Bordi Edges. Bords. Kanten.	Spessore Thickness. Épaisseur. Stärke.	Resistenza allo scivolamento Slip resistance. Résistance au glissement. Rutschfestigkeit.							Resistenza alle macchie (Pulibilità) Resistance to staining. Résistance aux produits tachants. Flecken Beständigkeit.	Resistenza agli acidi e alle basi Resistance to acids and bases. Résistance aux acides et aux bases. Beständigkeit gegen Säuren und Laugen.		
			DIN EN 16165: 2023 Annex B	DIN EN 16165: 2023 Annex A	AS/NZS 4586	BS EN 16165	UNE-ENV 12633	B.C.R.A. Rep CEC/81	DCOF Ansi A 326.3			ISO 10545/14	ISO 10545/13
1.4													
60x60	Ret	14 mm	R10	-	-	-	-	> 0,40	≥ 0,42 Wet	5	A . LA . HA		
20 MM													
GRIP	Ret	20 mm	R11	A+B+C	P4	≥ 36 Wet	Classe C3	> 0,40	≥ 0,62 Wet	5	A . LA . HA		

Caratteristiche tecniche di supporto

Physical properties of the tile's body.
Caractéristiques techniques du corp du carreau.
Technische Eigenschaften des Scherbens.

277

Gres Porcellanato Porcelain Stoneware Grès Cérame Feinsteinzeug	Norma Standard Norme Norm	Valore prescritto dalle norme Values required by the standard Valeur prescrite par les normes Normvorgabe UNI EN 14411 Bia (ALLEGATO G)	Valore Sichenia Sichenia values Valeur Sichenia Sichenia Werte
Lunghezza e larghezza Length and width Longeur et largeur Länge und Breite	UNI EN ISO 10545/2	Naturale ± 0,6% (max ± 2 mm) Natural Rettificato ± 0,3% (max ± 1 mm) Rectified	Conforme Compliant
Spessore Thickness Épaisseur Stärke	UNI EN ISO 10545/2	Naturale ± 5% (max ± 0,5 mm) Natural Rettificato ± 5% (max ± 0,5 mm) Rectified	Conforme Compliant
Rettilinearità spigoli Warpages of edges Rectitude des arêtes Geradheit der Kanten	UNI EN ISO 10545/2	Naturale ± 0,5% (max ± 1,5 mm) Natural Rettificato ± 0,3% (max ± 0,8 mm) Rectified	Conforme Compliant
Ortogonalità Wedging Ortogonalité Rechtwinkligkeit	UNI EN ISO 10545/2	Naturale ± 0,5% (max ± 2 mm) Natural Rettificato ± 0,3% (max ± 1,5 mm) Rectified	Conforme Compliant
Planarità Flatness Planéité Planität	UNI EN ISO 10545/2	Naturale ± 0,5% (max ± 2 mm) Natural Rettificato ± 0,4% (max ± 1,8 mm) Rectified	Conforme Compliant
Assorbimento d'acqua Water absorption Absorption d'eau Wasseraufnahme	UNI EN ISO 10545/3	≤ 0,5%	≤ 0,1%
Resistenza alla flessione Bending strength Résistance à la flexion Biegezugfestigkeit	UNI EN ISO 10545/4	≥ 35 N/mm ²	Conforme Compliant
Dilatazione termica lineare tra 20° e 100 °C Linear thermal expansion between 20° and 100 °C Dilatation thermique linéaire entre 20° et 100 °C Lineare Wärmeausdehnung zwischen 20° und 100 °C	UNI EN ISO 10545/8		< 9,0x10 ⁻⁶ K ⁻¹
Resistenza agli sbalzi termici Thermal shock resistance Résistance aux écarts de température Temperaturwechselbeständigkeit	UNI EN ISO 10545/9	Test superato in accordo con ISO 10545-1 Pass according to EN ISO 10545-1	Nessuna alterazione No alteration
Resistenza al gelo Frost resistance Résistance au gel Frostbeständigkeit	UNI EN ISO 10545/12	Test superato in accordo con ISO 10545-1 Pass according to EN ISO 10545-1	Nessuna alterazione No alteration
Resistenza all'abrasione profonda Resistance to deep abrasion Résistance a l'abrasione profonde Tiefenabrieb	UNI EN ISO 10545/6	≤ 175 mm ³	≤ 140 mm ³
Sforzo di rottura Breaking strength. Effort de rupture. Bruchkraft.	UNI EN ISO 10545/4	≥ 1300 N	Conforme Compliant

Tabella dei calibri

Calibre table.
Tableau des calibres.
Tabelle der Kaliber.

Formato nominale. Nominal size. Format Nominal. Nennformat.	Calibro centrale naturale da pressa Natural press central caliber Calibre central naturel de presse Zentralkaliber (Presskante)	Calibro centrale Rettificato Central calibre rectified Calibre central réctifié Zentralkaliber Rektifiziert	Percentuale di scostamento fra dimensione nominale e di fabbricazione EN ISO 13006. Percentage difference between nominal size and manufacturing size EN ISO 13006. Pourcentage d'écart entre la dimension nominale et de fabrication EN ISO 13006. Abweichungsprozentsatz zwischen der Nenn- und Fertigungsabmessung EN ISO 13006.
cm	mm	mm	%
7,2x7,2	/	72,5x72,5	+/-2% (Max ± 5 mm)
7,2x30	/	72,5x297,5	+/-2% (Max ± 5 mm)
8x41	82x413	/	+/-2% (Max ± 5 mm)
16,5x41	167x413	/	+/-2% (Max ± 5 mm)
11x45	111,60x452,5	/	+/-2% (Max ± 5 mm)
22,5x22,5	224,25x224,25	/	+/-2% (Max ± 5 mm)
22,5x45	224,25x452,5	/	+/-2% (Max ± 5 mm)
10x60	97,8x597	/	+/-2% (Max ± 5 mm)
20x60	197x597	/	+/-2% (Max ± 5 mm)
30x30	/	297,5x297,5	+/-2% (Max ± 5 mm)
30x60	/	297,5x597	+/-2% (Max ± 5 mm)
60x60	/	597x597	+/-2% (Max ± 5 mm)
30x90	/	297,5x896,5	+/-2% (Max ± 5 mm)
60x90	/	597x896,5	+/-2% (Max ± 5 mm)
90x90	/	896,5x896,5	+/-2% (Max ± 5 mm)
20x120	/	196x1196	+/-2% (Max ± 5 mm)
30x120	/	297,5x1196	+/-2% (Max ± 5 mm)
40x120	/	397x1196	+/-2% (Max ± 5 mm)
60x120	/	597x1196	+/-2% (Max ± 5 mm)
120x120	/	1196x1196	+/-2% (Max ± 5 mm)

Formato nominale: Dimensione che viene usata per designare il prodotto, (60x120, 60x60, ecc.)

Dimensione di fabbricazione: Dimensione di una piastrella prefissata e alla quale la dimensione reale si deve avvicinare entro limiti ammessi di tolleranza.

Calibro: Dimensione reale del prodotto contenuto nella scatola, chiaramente specificato sulla stessa nonché nei documenti di vendita.

Nominal size: Size used to describe the product, (60x120, 60x60, etc.)

Manufacturing size: Predetermined size of a tile, which the actual tile must comply with, within allowed limits of tolerance.

Work size: Real size of the product contained in the box, clearly specified on the box and in the sales documents.

Dimension nominale : dimension utilisée pour désigner le produit (60x120, 60x60, etc.)

Dimension de fabrication : dimension préétablie d'un carreau et de laquelle doit s'approcher la dimension réelle dans les limites de tolérance admise.

Calibre : dimension réelle du produit présent dans la boîte, clairement spécifié sur cette dernière et sur les documents de vente.

Nennmaß: Dieses Maß wird zur Festlegung des Produktes verwendet (60x120, 60x60, usw.)

Produktionsmaß: Dabei handelt es sich um das festgelegte Fliesenmaß, dem sich das Istmaß der Fliese innerhalb der zulässigen Toleranzen nähern soll.

Kaliber: Das ist das Istmaß des im Karton befindlichen Produktes, das deutlich auf dem Karton und in den Verkaufsunterlagen angegeben ist.

Nota relativa alle misure (lunghezze e peso).

Information regarding the measures (lengths and weight).

Note informative concernant les mesures (longueurs et poids).

Anmerkung zu den Maßnahmen (Längen und Gewicht).

Le misure in pollici sono indicative. Le misure in cm sono da considerarsi nominali e sono le uniche da usare come riferimento.

Tutti i pesi sono dei valori medi, al netto dell'imballo.

The sizes in inches are indicative. The sizes in cm are real and to be used as reference. Avarage weight, net of packaging.

Les dimensions en pouces sont indicatives. Les dimensions en cm sont nominales et elles constituent la seule référence. Poids moyen, net d'emballage.

Die Abmessungen in Zoll sind Richtwerte. Die Abmessungen in cm sind als Nennwerte zu betrachten und sind die einzigen, die als Bezug zu verwenden sind.

Durchschnittliches Gewicht nach Verpackung

La classificazione delle tonalità

Color Shade Variation Guide.

Classification des tonalités.

Farbspiel-Klassifizierung.

Per cromatismo o tonalità si intendono le differenze di colore e struttura che possono caratterizzare singole piastrelle di una stessa produzione oppure partite di produzioni diverse. Per valutare una tonalità (ed eventuali differenze nello standard) è consigliabile disporre sempre più piastrelle vicine.

Eventuali contestazioni relative a differenze di tono devono sempre essere avanzate prima della posa.

The color shade or shades of all tile varies some degree from piece to piece, from each production run to run. At least several pieces from the same production run should be reviewed whenever possible to determine acceptable color shade variations.

Any questions or concerns about your tile selection should be clarified prior to installation.

Par chromatisme ou bien tonalité, on entend des différences de couleur ou bien structure pouvant caractériser une partie des carreaux de la même production ou bien des lots de productions différents. De manière à pouvoir juger d'une tonalité (et d'éventuelles différences par rapport au "standard") on conseille de toujours étendre par terre un certain nombre de carreaux.

D'éventuelles réclamations concernant les différences de tonalité doivent toujours être signalées avant la pose des carreaux.

Unter "Farbspiel" oder "Nuancierung" versteht man die Farb- und Strukturunterschiede, die sich innerhalb einer Produktion zwischen einzelnen Fliesen oder auch zwischen unterschiedlichen Fliesenproduktionschargen ergeben koennen. Zur Beurteilung eines Farbtones (und eventueller Abweichungen vom Standard) ist es immer empfehlenswert, verschiedene Stuecke nebeneinander zu beurteilen.

Eventuelle Beanstandungen bezüglich abweichender Farbton- Nuancen muessen immer vor der Verlegung geltend gemacht werden.

V1



CROMATISMO OMOGENEO
Le differenze tra le varie piastrelle sono minime e quasi impercettibili.

UNIFORM APPEARANCE
Differences among pieces from the same production run are minimal.

CHROMATISME OMOGÈNE
Les variations entre les différents carreaux sont minimales et presque imperceptibles.

GLEICHFOERMIGES FARBSPIEL
Die Farbunterschiede der einzelnen Fliesen sind minimal und kaum wahrnehmbar.

V2



LEGGERO GIOCO CROMATICO
Differenze di tono e struttura sono chiaramente visibili, il gioco cromatico si muove però su un colore di fondo specifico.

SLIGHT VARIATION
Clearly distinguishable differences in texture and/or pattern within similar colors.

LEGÈRES VARIATIONS CHROMATIQUES
Les différences de ton et/ou de structure sont clairement visibles alors que la gamme de variations chromatique se manifeste à l'intérieur d'une couleur de base bien spécifique.

LEICHTES FARBSPIEL
Farb- und Strukturunterschiede zwischen einzelnen Fliesen sind deutlich sichtbar, das Farbspiel bewegt sich aber innerhalb eines spezifischen Grundtones.

V3



GIOCO CROMATICO VISIBILE
Colori e strutture visibili su una piastrella possono dare solo una indicazione generale del gioco cromatico che si andrà a comporre. Così un colore appena accennato su una piastrella potrà essere il colore dominante di un'altra piastrella della stessa partita.

MODERATE VARIATION
While the colors present on a single piece of tile will be indicative of the colors to be expected on the other tiles, the amount of colors on each piece may vary significantly. For example "that little bit of color" on one piece of tile may be the primary color on the next piece.

VARIATIONS CHROMATIQUES VISIBLES
Les couleurs et les structures visibles sur un carreau peuvent seulement représenter une indication d'ordre général du "jeux chromatique" qui va se créer après la pose des carreaux; ainsi, une couleur à peine perçue sur un seul carreau pourrait représenter la couleur principale d'un autre carreau de la même fabrication.

SICHTBARES FARBSPIEL
Die Farben und Strukturen, die auf einer Fliese sichtbar sind koennen nur einen allgemeinen Hinweis auf das insgesamt zu erwartende Farbspiel geben. So kann z.B. ein auf einer Fliese nur minimal sichtbarer Anteil eines Farbtones auf einer anderen Einzelfliese der selben Liefercharge dominierend sein.

V4



FORTE GIOCO CROMATICO
Le piastrelle possono presentare colori completamente diversi una dall'altra. Per questo motivo una singola piastrella non può fornire un'indicazione sufficiente del gioco cromatico complessivo che si verrà a creare sulla superficie posata. L'impressione ottica complessiva del materiale può essere valutato solo su una superficie abbastanza estesa.

RANDOM VARIATION
Random color differences from tile to tile, so that on tile may have totally different colors from that on other tiles. Thus, the final installation will be unique.

VARIATIONS CHROMATIQUES IMPORTANTES
Les carreaux peuvent présenter des couleurs complètement différentes entre eux. Pour cette raison, un seul carreau ne peut pas fournir une indication suffisante du "jeux chromatique" général qui va se créer après la pose. L'impression visuelle générale du produit ne peut être déterminée que sur une surface assez importante.

STARKES FARBSPIEL
Die Einzelfliesen koennen im Zufalls- verfahren ganz unterschiedliche Farben und Strukturen aufweisen. Eine Einzelfliese kann daher keinen ausreichenden Hinweis auf das gesamte Farbspiel in der verlegten Flaechе geben. Der optische Gesamteindruck des Materiales kann nur anhand einer grosseren Flaechе beurteilt werden.

I PEZZI SPECIALI

TRIMS.
LES PIÈCES SPÉCIALES.
DIE FORMTEILE.

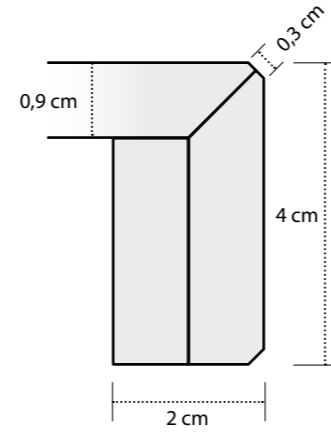

Gradino costa retta

Angolo SX / DX

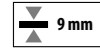

280



Gradino Becco di Civetta con Righe

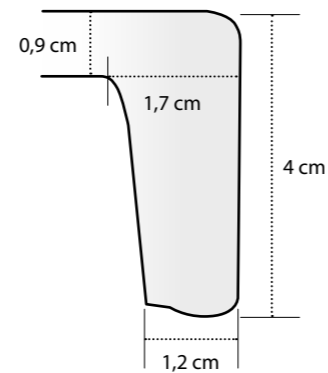
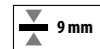

Elemento a "L" 15x30x4

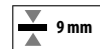

Battiscopa

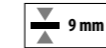

14 mm



Gradino Costa Retta

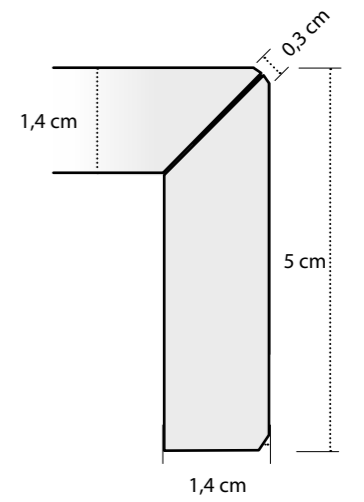

Gradino Costa Retta Angolo Interno



Gradino Costa Retta Angolo Esterno



281



Gradino costa lucida

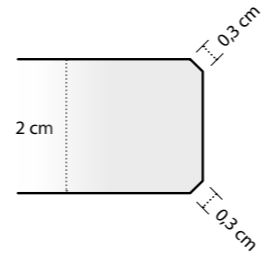

Gradino costa lucida Angolo Interno Dx-Sx



Gradino costa lucida Angolo Esterno Dx-Sx



Gradino Toro



Gradino Toro - Angolo Interno Dx-Sx



Gradino Toro - Angolo Esterno Dx-Sx



Griglia



Angolo Griglia Dx-Sx



ATTENZIONE . BE CAREFUL . ATTENTION . ACHTUNG

Essendo di spessori leggermente diversi, il fondo va compensato in posa.

Tile and grid are of different thickness so they must be compensated with the laying.

Les unis et les grilles ont une épaisseur différente, donc, il faudra la compenser lors de la pose.

Unifliese und Gitter haben unterschiedlichen dicke, daher müssen beim Einbau ausgeglichen werden.

Ordinabile su richiesta.

Orderable on request.

Disponible sur demande.

Disponible sur demande.



Gradino Costa Retta

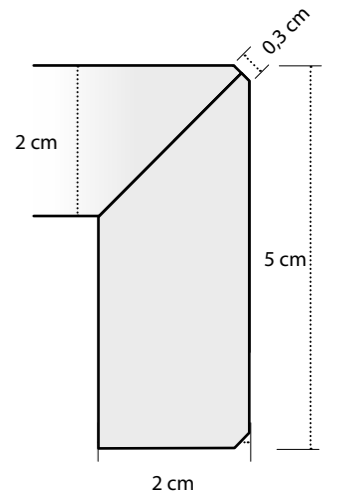

Gradino Costa Retta Angolo Interno



Gradino Costa Retta Angolo Esterno



282

Su richiesta possono essere realizzati pezzi con gocciolatoio e/o con fresature antiscivolo.

Auf Anfrage können die Stufenelemente mit Tropfnase oder/und antislip Rillen hergestellt werden.

Bord antidérapant avec goutte à goutte.

Drip and anti-slip grooves can be made.



Copertina con gocciolatoio

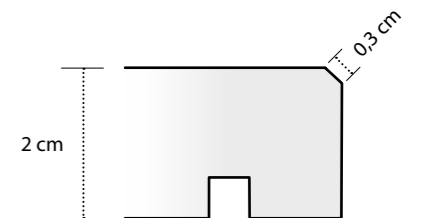

ATTENZIONE . BE CAREFUL . ATTENTION . ACHTUNG

Ordinabile su richiesta . Orderable on request . Disponible sur demande . Auf Anfrage bestellbar

Consigli di posa

Laying suggestions.
 Conseils pour la pose.
 Verlegehinweise.

LA POSA

Le piastrelle in gres porcellanato Sichenia, grazie alle materie prime utilizzate ed alle nuove tecnologie produttive, tendono ad imitare la casualità delle pietre naturali; le variazioni cromatiche sono dunque una caratteristica di pregio che un abile posatore può valorizzare al fine di creare un pavimento unico. A tale scopo si consiglia di eseguire durante la posa le seguenti operazioni.

- Controllare accuratamente il calibro dei diversi formati e i toni del prodotto. Stendere a terra alcune scatole di materiale per verificare l'effetto di insieme. Posare attingendo da scatole diverse.
- Non immergere il materiale in acqua prima della posa.
- Battere le piastrelle sino alla totale scomparsa di bolle d'aria nella malta.
- Non segnare la superficie con pennarelli.
- Terminata la posa lavare accuratamente le piastrelle con acqua e detersivi a base acida per togliere incrostazioni e residui cementizi dalle fughe.

LA FUGA

Nella posa dei materiali rettificati, soprattutto in assenza di bisellatura, è necessario adottare una cura particolare nel livellare i singoli pezzi fra loro. Come capita spesso con le pietre naturali, le legere ed inevitabili differenze di livello fra pezzo e pezzo, messe in evidenza dalla particolare finitura del bordo, sono da considerarsi normali. Il seguente specchietto rappresenta un utile strumento cui fare riferimento per la dimensione delle fughe in relazione al tipo di posa e di materiale utilizzati.

LA STUCCATURA

- Stuccare il pavimento 24/48 ore dopo la posa, le fughe devono essere perfettamente pulite.
- Stuccare piccole superfici per volta (4/5 m²) e lavare accuratamente più volte con acqua.
- Si suggerisce un colore dello stucco tono su tono del materiale.
- Superficie Lux - Utilizzare stucchi cementizi con colori tono su tono

Tipo di posa per interno	Bordi Naturali	Bordi rettificati
Combinazione di più formati Posa "a correre" Formato unico	4 mm. (obbligatoria) 3 mm. (almeno) 3 mm. (almeno)	2 mm. (obbligatoria) 2 mm. (almeno) 2 mm. (almeno)

FIXING

Thanks to the raw materials used and the new productive technologies applied, Sichenia's porcelain stoneware tiles are able to imitate the random appearance of natural stone. The chromatic color variation is a feature of great value for a tile installer who wishes to create a unique floor.

- To enhance the product and fixing, we recommend to carry out the following operations:
 - Check accurately the caliber of different size tiles and their shades. Set out on the floor few cartons of material in order to verify the layout.
 - Fix by using tiles from different cartons.
 - Do not immerse in water the tile before fixing it.
 - Tap the fix tile in order to eliminate all air bubble from the mortar.
 - Do not mark the tile with felt-tipped pen.
- When finish fixing, clean accurately the tiles surface with water and an acid-based detergent to remove any grout joint residuals.

JOINT

When installing rectified materials, and especially with unchamfered edges, particular care is necessary to level each individual piece.

As is often the case with natural stone, small level differences from piece to piece, emphasised by the edge finish, are normal. The following table provides useful indications for the correct joint size to use for different installation types and materials.

GROUTING

- Grout the floor 24/48 hours after fixing it, the grout joint has to be clean thoroughly.
- 4mm joint and a tone on tone putty are recommended.
- Grout small surface at a time (approx. 4 to 5 m² square meter) and rinse it accurately with water.
- Lux surface - Use cement-based grout with tone on tone colours.

Laying solution for indoor	Natural edges	Rectified edges
Combination of multiple sizes Straightforward pattern Single size	4 mm. (mandatory) 3 mm. (at least) 3 mm. (at least)	2 mm. (mandatory) 2 mm. (at least) 2 mm. (at least)

Indicazioni di posa

Laying instructions.
 Indications de pose.
 Hinweise zur Verlegung.

POSA "A CORRERE": nei formati fino a 100 cm sfalsatura massima consigliata da 6 a 10 cm.
 Con dimensioni superiori a 100 cm si consiglia una sfalsatura massima da 20 a 25 cm.

Staggered laying design: formats up to 100 cm, should be staggered by a maximum of 6 to 10 cm.
 Formats larger than 100 cm can be staggered by a maximum of 20 to 25 cm.

Pose en décalé : avec les formats jusqu'à 100 cm, le décalage maximal conseillé est compris entre 6 et 10 cm. Pour les formats supérieurs à 100 cm, le décalage maximal conseillé est compris entre 20 et 25 cm.

Versetzte Verlegung: Es wird empfohlen 6 bis 10 Centimeter versetzt zu verlegen für die Länge bis 100 cm. Platten länger wie 100 cm sollen maximal 20 bis 25 cm versetzt verlegt werden.

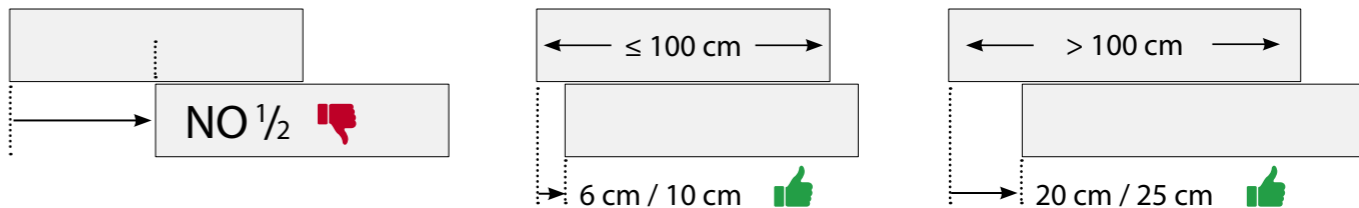

Posa con distanziatori livellanti

Laying with levelling spacers
 Pose avec les cales de nivellement
 Das Verlegen mit Selbstnivellierenden Abstandhaltern

Per il rivestimento di pavimenti e pareti mediante formati con lato superiore a 60 cm, Sichenia raccomanda di affidarsi al distanziatore livellante proposto da Raimondi, Levelling System che consente facilmente di:

- Rendere perfettamente planare la superficie posata;
- Mantenere la posizione desiderata di ogni piastrella;
- Ridurre i tempi di posa.

I distanziatori livellanti per piastrelle permettono di ottenere pavimenti livellati con semplicità e rapidità.

For flooring and wall cladding using formats with sides of over 60 cm, Sichenia recommends the use of Raimondi levelling spacers, Levelling System which make it easy for you to:

- Ensure that the laid surface is entirely flat;
- Maintain the desired position for each tile;
- Reduce laying time.

Levelling spacers for tiles enable you to create level flooring in a quick and easy way.

Pour le revêtement de sols et murs à l'aide d'un carrelage dont un côté dépasse les 60 cm, Sichenia conseille d'utiliser les cales de nivellement proposées par Raimondi, Levelling System qui permet facilement de :

- Nivelier parfaitement la surface posée;
- Conserver l'emplacement souhaité pour chaque carreau;
- Réduire le temps de pose.

Les cales de nivellement pour carreaux permettent d'obtenir des sols nivelés en toute simplicité et avec rapidité.

Zur Verkleidung von Fußböden und Wänden mit Formaten, deren obere Seite 60 cm misst, empfiehlt Sichenia die Nutzung von nivellierenden Abstandshaltern von Raimondi (Levelling System) ist es möglich:

- Die verlegte Oberfläche perfekt eben zu machen;
- Die gewünschte Position jeder Fliese beizubehalten;
- Die Verlegzeiten zu reduzieren.

Die nivellierenden Abstandhalter für Fliesen stellen ein einfaches und schnelles System dar, nivellierte Fußböden zu verlegen.



LA POSE

Les carreaux en gres c erame de Sichenia, par les mati eres premi eres utilis ees et gr ace aux nouvelles technologies de production, ont tendance   s'approcher aux vraies pierres naturelles dont ils imitent l'aspect non homog ene des nuances. Ces variations chromatiques repr esentent un enrichissement du produit qui peut  tre exploit  par un bon professionnel de mani ere   obtenir un sol pratiquement unique. Pour mieux mettre en valeur le produit ainsi que la pose, il est conseill  d'effectuer les op erations suivantes:

- Contr oler soigneusement le calibre des differents formats ainsi que leur nuance. Etendre par terre le contenu de quelques bo tes pour en verifier l'effet d'ensemble. Poser les carreaux en les pr elevant de differentes bo tes.
- Eviter de plonger les carreaux dans l'eau avant la pose.
- Taper les carreaux jusqu'  la disparition totale d' ventuelles bulles d'air dans la chape.
- Ne pas tracer la surface des carreaux avec des feutres.
- Une fois la pose termin e, laver soigneusement les carreaux   l'eau avec des d tergents   base acide pour  liminer des joints les incrustations et le ciment residuel.

LES JOINTS

Pour poser les mati riaux rectifi s, en particulier avec des c t s non biseaut s, il est indispensable de niveler les pi ces avec une tr s grande attention. Comme c'est souvent le cas pour les pierres naturelles, les l g eres diff rences de niveau in vitables entre les pi ces, davantage visibles en raison de la finition particuli re du bord, doivent  tre consid r es comme normales. Le tableau suivant constitue un instrument utile auquel faire recours pour dimensionner les joints, par rapport au type de pose et au mati riaup appliqu .

LE REMPLISSAGE DES JOINTS

- Remplir les joints 24/48 heures apr s la pose du sol; les joints doivent  tre parfaitement nettoy s.
- La dimension du joint conseill e est de 4 mm. On conseille une couleur des joints ton sur ton.
- Jointoier de petites portions de sol   la fois (4/5 m²) puis nettoyer soigneusement   l'eau   plusieurs reprises.
- Surface Lux - Utiliser des mortiers-joints avec des couleurs ton sur ton.

Solution de pose pour int�rieur	Bords naturels	Bords rectifi�s
Application de plusieurs formats Pose « � bandes libres » Un seul format	4 mm (obligatoire) 3 mm. (minimum) 3 mm. (minimum)	2 mm. (obligatoire) 2 mm. (minimum) 2 mm. (minimum)

DIE VERLEGUNG

Dank ihrer fortschrittlichen Produktionstechnik imitieren die Sichenia-Feinsteinzeuge das 'zufaellige' und lebhaftes Ausdruckspektrum echter Natursteine. Die Farb- und Oberflaechenschwankungen der einzelnen Fliesen sind daher eine besondere Wertigkeit dieser Fliesen und geben (bei entsprechender Verlegung) dem Bodenbelag seine spezielle, einzigartige Gesamtwirkung. Um ein optimales Verlegeergebnis zu erzielen, empfehlen wir folgende Hinweise zu beachten:

- Kontrollieren Sie auf den einzelnen Kartons die Farbton- und Kaliberangaben.
- Legen Sie einige Kartons zur Probe aus, um die Flaechenwirkung im Verlegeverband zu beurteilen.
- Verlegen Sie immer aus verschiedenen Kartons gleichzeitig.
- Das Material darf vor der Verlegung NICHT gewaessert werden.
- Auf eine vollsattte Verlegung ist zu achten.
- Markieren Sie die Fliesen nicht mit Filzstiften o. .
- Nach der Verlegung ist die Feinsteinzeuge zuegig und grundlich mit entsprechenden (sauren) Reinigungsmitteln abzuwaschen, um jedewede Zementreste von der Oberflaechen und aus den Fugen zu entfernen.

Die Fugenbreite

Beim Verlegen von geschliffenen Fliesen, besonders bei nicht abgeschr gten Kanten, muss bei der Ausrichtung der einzelnen Fliesen aneinander besondere Sorgfalt verwendet werden. Wie es h ufig bei Natursteinen der Fall ist, sind leichte und unvermeidbare H henunterschiede zwischen den einzelnen St cken, die durch die besondere Kantengestaltung betont werden, als normal zu betrachten. Die folgende Tabelle ist ein n tzlicher Anhaltspunkt f r die Fugenbreite jeweils in Bezug zur Verlegeart und dem verwendeten Material.

DIE VERFUGUNG

- Die Verfugung sollte 24/48 Stunden nach der Verlegung erfolgen. Die Fliesenflanken sollten moeglichst sauber sein.
- Der beste optische Eindruck wird mit einer Fugenfarbe 'Ton-in-Ton' mit der Grundfliese erreicht.
- Es sollten immer nur kleine Einzelflaechen (je 4-5 qm) verfugt werden und danach sollte jeweils unverzueglich und mehrfach mit reichlich Wasser nachgewaschen werden.
- Lux Oberflaechen - Sollten Zementkitten in  hnlichen Farbt nen verwendet werden.

Verlegeart	Nat�rliche Kanten	Rektifizierte Kanten
Kombination verschiedener Formate Gerade fortlaufende Verlegung Nur ein Format	4 mm (obligatorisch) 3 mm (mindestens) 3 mm (mindestens)	2 mm (obligatorisch) 2 mm (mindestens) 2 mm (mindestens)

PULIZIA E MANUTENZIONE

Pulizia di un pavimento in ceramica con un prodotto a base di acido

Prima di pulire una superficie piastrellata è bene:

1.Verificare sul catalogo generale la **resistenza agli agenti chimici** delle piastrelle posate;
2.Effettuare un test preliminare direttamente sulle piastrelle posate, ponendo il detergente da utilizzare a contatto con le piastrelle per tempi uguali a quelli che si useranno poi sul cantiere;
3.Assicurarsi che i detersgenti da usare **non contengano** acido fluoridrico e/o suoi derivati, poiché tali sostanze, per loro peculiarità, aggrediscono tutti i prodotti ceramici.
Si riportano di seguito alcune indicazioni per le pulizie di fine cantiere (“dopo posa”), quotidiane, straordinarie, per la rimozione di cere e patine lucidanti e per eventuali manutenzioni straordinarie.

PERCHÈ LA PULIZIA “DOPO POSA”!

1.La pulizia “dopo posa” serve per rimuovere i residui di stucchi per le fughe, cemento, calce, boiacca. È obbligatoria a fine cantiere, sia per le piastrelle smaltate che per quelle non smaltate.
2.Una pulizia “dopo posa” male effettuata, o addirittura non fatta, è spesso causa di aloni che impediscono di mantenere pulito il pavimento nonostante una buona pulizia quotidiana.
3.Quando possibile, specialmente per superfici medio-grandi, si consiglia l’uso di monospazzola con dischi morbidi (bianchi oppure beige).

INDICAZIONI PER LA PULIZIA “DOPO POSA”:

1.Effettuare la pulizia dopo 4-5 giorni dalla stuccatura (lo stucco deve indurire) e non oltre 10 giorni. Oltre questi tempi la pulizia può diventare molto più laboriosa.
2.Bagnare con acqua il pavimento prima delle operazioni di pulizia. In questo modo le stuccature vengono impregnate dall'acqua e viene ridotto il contatto con i detersgenti.
3.Lasciare agire i detersgenti per tempi limitati, risciacquando bene con acqua appena possibile.
4.Non deve essere eseguita se le superfici piastrelate sono molto calde (es. esposte al sole nei mesi più caldi), perché diviene più severa l'azione degli aggressivi chimici. In estate effettuarla nelle ore fresche della giornata.

5.Fare *sempre test* preventivi prima dell’uso (su una piastrella non posata), in particolare per prodotti Lappati o Levigati.

6.Pulizia stucchi cementizi miscelati con acqua

Si effettua con specifici detersgenti a base di acidi tamponati e diluiti. Alcuni di questi, facilmente reperibili in commercio, sono riportati nella seguente tabella.

RESIDUO DA RIMUOVERE FOR REMOVING THE FOLLOWING RESIDUES	TIPO DETERGENTE TYPE OF DETERGENT	NOME DETERGENTI DETERGENT’S NAME	PRODUTTORE MANUFACTURER	SITO INTERNET WEBSITE
stucchi cementizi . cement-based grouts <p>boiacca . grout cemento . cement calce . lime</p>	a base di acidi tamponati buffered acid based	keranet <p>cement remover deterdeK trek zementschleierentferner hmk r63 solvacid</p>	Mapei <p>Faberchimica Fila Kiter Lithofin Hmk Geal</p>	www.mapei.it <p>www.faberchimica.com www.filachim.it www.kiterdetergenti.it www.lithofin.com www.moellerchemie.de www.geal-chim.it</p>
bonaclean/bclean		Bonasystems italia	Bonasystems italia	www.bonasystemsitalia.it
bonadecon/bdecon (*)		Bonasystems italia	Bonasystems italia	www.bonasystemsitalia.it

Salvo diversa indicazione di SICHENIA, seguire attentamente le modalità d’uso indicate sulle confezioni dai fabbricanti. (*) Specifico per proddotti non resistenti agli acidi.

7.Pulizia stucchi epossidici, bi-componenti e reattivi

In questi casi la rimozione dei residui degli stucchi deve essere fatta immediatamente ed in modo molto accurato seguendo le indicazioni dei fabbricanti, perché questi stucchi induriscono molto rapidamente, anche in pochi minuti. Seguire attentamente le modalità di pulizia indicate dal fabbricante dello stucco utilizzato e verificarne l’efficacia (anche controlluce!) con una prova preliminare di pulizia prima di stuccature l’intero pavimento/parete.

NOME DETERGENTI . DETERGENT’S NAME	PRODUTTORE . MANUFACTURER	SITO INTERNET . WEBSITE
Epoxy Cleaner	Faberchimica	www.faberchimica.com

8.Piastrelle antiscivolo

Le piastrelle “grip”, realizzate con superfici ruvide e/o strutturate, si puliscono ovviamente in modo più laborioso. Si consiglia perciò di effettuare la pulizia “dopo posa” in modo rapido ed accurato, utilizzando quando possibile monospazzola con dischi bianchi e beige.

PULIZIA:

Viene effettuata per rimuovere macchie o residui particolarmente vecchi o resistenti. Prima dell'uso fare sempre test preventivi (su una piastrella non posata), in particolare su **Lappati e Levigati**. Nella tabella sotto sono indicati detersgenti efficaci a seconda del tipo di macchia.

RESIDUO DA RIMUOVERE FOR REMOVING THE FOLLOWING RESIDUES	TIPO DETERGENTE TYPE OF DETERGENT	NOME DETERGENTI DETERGENT’S NAME	PRODUTTORE MANUFACTURER	SITO INTERNET WEBSITE
grassi . grease <p>polvere da calpestio . dust footmarks pulizie di fondo . base cleaning</p>	polifunzionali . multipurpose <p>a base alcalina(1) . alkaline-based (1)</p>	ps87 <p>intensivreiniger hmk r55 taski r20-strip bonadecon / bdecon deterflash Oil & Grease Remover coloured stain remover</p>	Fila <p>Lithofin Hmk Johnsondiversey Bonasystems italia Geal Faberchimica Faberchimica</p>	www.filachim.it <p>www.lithofin.com www.moellerchemie.de www.diverseysolutions.com www.bonasystemsitalia.it www.geal-chim.it www.faberchimica.com www.faberchimica.com</p>
caffè . coffee coca-cola . coke succhi di frutta . fruit juice	polifunzionali . multipurpose <p>a base alcalina(1) . alkaline-based (1)</p>	ps87 <p>super deterjet candeggina oxidant candeggina</p>	Fila <p>Geal vari produttori vari produttori</p>	www.filachim.it <p>www.geal-chim.it</p>
vino . wine <p>depositi calcarei . calcareous deposits</p>	ossidante . oxidizing agent <p>a base acida (1) . acid-based (1)</p>	viakal	Procter & Gamble	it.pg.com
ruggine . rust	a base acida (1) . acid-based (1)	acido muriatico diluito	vari produttori	
inchiostrri . inks pennarello . felt-tipped pen	a base solvente . solvent-based	diluente nitro, acqua ragia coloured stain remover	vari produttori Faberchimica	www.faberchimica.com
pneumatici . pneumatic segni di gomma . stains from rubber segni di metalli . stains from metals segni di matita . stains from pencils	pasta abrasiva (1) . abrasive paste (1)	vim clorex (2) polishing cream (2) tile cleaner (3) detergum (3)	Guaber Faberchimica Faberchimica Zep italia	www.faberchimica.com www.faberchimica.com www.faberchimica.com www.zep.it
sporco delle fughe . tile joint stains	specifico . specific	fuganet fugenreiniger	Fila Lithofin	www.filachim.it www.lithofin.com

1) Fare test preventivo su materiali Lappati e Levigati
2) Indicato per materiali Lappati e Levigati
3) Non usare su prodotti Lappati, usare con molta attenzione sui Levigati. Salvo diversa indicazione di SICHENIA seguire attentamente le modalità d’uso indicate sulle confezioni dai fabbricanti.

CLEANING AND MAINTENANCE INFORMATION

Pulizia di un pavimento in ceramica con un prodotto a base di acido

Make sure to do the following before cleaning any tiled surface:

1.Check the **resistance to chemical agents** of the laid tiles on the general catalogue;
2.Make a preliminary test directly on the laid tiles by putting a detergent, to be used in contact with the tiles for a period that is equal to the period that will be used later on the site;
3.Make sure that the detergents that are going to be used, **do not contain** hydrofluoric acid and/or any of its derivatives; these substances are distinctively known for damaging all ceramic products. Some indications for cleaning after the installation (after laying the tiles), on a daily basis, extra cleaning and to remove waxes and polish glazes or for any extra maintenance that may be required, are listed here below.

WHY “AFTER THE INSTALLATION” CLEANING!

1.Cleaning “after the installation” helps remove residues of grout-joints, cement and lime. This is obligatory at the end of the installation, for glazed tiles and unglazed tiles.
2.If the cleaning “after the installation” is not carried out properly or if is not carried out at all, is often a cause of marks that prevent the floor from being clean even if a good daily cleaning is performed.
3.Whenever is possible, especially for medium to large surfaces, it is advisable to use a single-brush machine with soft disks (white or beige).

INSTRUCTIONS ON HOW TO CLEAN “AFTER THE INSTALLATION”:

1.Clean 4-5 days after the grouting (the grout must be hardened); do not wait over 10 days. In addition to this period, the cleaning can become very laborious.
2.Moisten the floor with water before cleaning. This way the groutings are soaked with water and the contact with detergents is reduced.
3.Let the detergents operate for limited periods, hence rinse out with water as soon as possible.
4.It must not be carried out if the tiled surfaces are very hot (i.e. exposed to the sun during very warm days); this must be avoided as the action of aggressive chemicals become very harsh. On the summer, proceed with the operation during the coolest period of the day.
5.Make sure to always perform a precautionary test before using the product (on a tile that is not laid), especially for Lapped or Polished products.
6.cleaning cement-based grouts mixed with water.
It is carried out with specific detergents based with buffered and diluted acids. The table below shows some of these detergents, which are easily available in the market.

RESIDUO DA RIMUOVERE FOR REMOVING THE FOLLOWING RESIDUES	TIPO DETERGENTE TYPE OF DETERGENT	NOME DETERGENTI DETERGENT’S NAME	PRODUTTORE MANUFACTURER	SITO INTERNET WEBSITE
stucchi cementizi . cement-based grouts <p>boiacca . grout cemento . cement calce . lime</p>	a base di acidi tamponati buffered acid based	keranet <p>cement remover deterdeK trek zementschleierentferner hmk r63 solvacid</p>	Mapei <p>Faberchimica Fila Kiter Lithofin Hmk Geal</p>	www.mapei.it <p>www.faberchimica.com www.filachim.it www.kiterdetergenti.it www.lithofin.com www.moellerchemie.de www.geal-chim.it</p>
bonaclean/bclean		Bonasystems italia	Bonasystems italia	www.bonasystemsitalia.it
bonadecon/bdecon (*)		Bonasystems italia	Bonasystems italia	www.bonasystemsitalia.it

Unless otherwise indicated by SICHENIA, follow the instructions indicated on the manufacturer’s package very carefully. (*) Specific for products that are non-resistant to acids.

7.Cleaning for epoxy, bi-component and reagent grouts

In these cases the removal must be carried out immediately and carefully following the recommendations of the manufacturers, as these grouts harden very fastly, even in a few minutes. Please carefully follow the cleaning mode specified by the manufacturer of the grout used; verify its effectiveness (backlight also) with a preliminary cleaning test before grouting the entire floor/wall.

NOME DETERGENTI . DETERGENT’S NAME	PRODUTTORE . MANUFACTURER	SITO INTERNET . WEBSITE
Epoxy Cleaner	Faberchimica	www.faberchimica.com

8.Antislip tiles

“Grip” tiles that are made with rough and/or textured surfaces must be cleaned very laboriously. Therefore, it is advisable to clean “after the installation”, quickly and thoroughly, using a single-brush machine with disks white and beige.

CLEANING:

This procedure is carried out to remove stains or residues that are particularly old or tough. Make sure to always perform a precautionary test before using the product (on a tile that is not laid), especially for **Lapped or Polished** products. The table shown below indicates the detergents that are effective according to the type of stains.

RESIDUO DA RIMUOVERE FOR REMOVING THE FOLLOWING RESIDUES	TIPO DETERGENTE TYPE OF DETERGENT	NOME DETERGENTI DETERGENT’S NAME	PRODUTTORE MANUFACTURER	SITO INTERNET WEBSITE
grassi . grease <p>polvere da calpestio . dust footmarks pulizie di fondo . base cleaning</p>	polifunzionali . multipurpose <p>a base alcalina(1) . alkaline-based (1)</p>	ps87 <p>intensivreiniger hmk r55 taski r20-strip bonadecon / bdecon deterflash Oil & Grease Remover coloured stain remover</p>	Fila <p>Lithofin Hmk Johnsondiversey Bonasystems italia Geal Faberchimica Faberchimica</p>	www.filachim.it <p>www.lithofin.com www.moellerchemie.de www.diverseysolutions.com www.bonasystemsitalia.it www.geal-chim.it www.faberchimica.com www.faberchimica.com</p>
caffè . coffee coca-cola . coke succhi di frutta . fruit juice	polifunzionali . multipurpose <p>a base alcalina(1) . alkaline-based (1)</p>	ps87 <p>super deterjet candeggina oxidant candeggina</p>	Fila <p>Geal vari produttori vari produttori</p>	www.filachim.it <p>www.geal-chim.it</p>
vino . wine <p>depositi calcarei . calcareous deposits</p>	ossidante . oxidizing agent <p>a base acida (1) . acid-based (1)</p>	viakal	Procter & Gamble	it.pg.com
ruggine . rust	a base acida (1) . acid-based (1)	acido muriatico diluito	vari produttori	
inchiostrri . inks pennarello . felt-tipped pen	a base solvente . solvent-based	diluente nitro, acqua ragia coloured stain remover	vari produttori Faberchimica	www.faberchimica.com
pneumatici . pneumatic segni di gomma . stains from rubber segni di metalli . stains from metals segni di matita . stains from pencils	pasta abrasiva (1) . abrasive paste (1)	vim clorex (2) polishing cream (2) tile cleaner (3) detergum (3)	Guaber Faberchimica Faberchimica Zep italia	www.faberchimica.com www.faberchimica.com www.faberchimica.com www.zep.it
sporco delle fughe . tile joint stains	specifico . specific	fuganet fugenreiniger	Fila Lithofin	www.filachim.it www.lithofin.com

(1) Make precautionary test on Lapped or Polished materials.
(2) Suitable for Lapped or Polished materials.
(3) Do not use it on Lapped; use it with the utmost caution on Polished products.
Unless otherwise indicated by SICHENIA, follow the usage instructions indicated on the manufacturer’s package very carefully.

Pulizia di un pavimento in ceramica con un prodotto a base di acido

PULIZIA QUOTIDIANA:

Utilizzare acqua calda e un panno in microfibra di buona qualità, tipo MAGICCLEAN di Bonasystems Italia. Ogni tanto, ad es. ogni 10-20 giorni a seconda dello stato della pavimentazione, utilizzare detersgenti neutri molto diluiti in acqua calda, che non contengono cere o non depositano patine lucide. A fine lavaggio risciacquare sempre con acqua, utilizzando un secondo panno in microfibra di buona qualità.

RESIDUO DA RIMUOVERE TYPE OF OPERATION	TIPO DETERGENTE TYPE OF DETERGENT	NOME DETERGENTI DETERGENT’S NAME	PRODUTTORE MANUFACTURER	SITO INTERNET WEBSITE
pulizie quotidiane clean on a daily bas	neutro neutral	tile cleaner <p>fila cleaner pflegereiniger hmk p15</p>	Faberchimica <p>Fila Lithofin Hmk</p>	www.faberchimica.com <p>www.filachim.it www.lithofin.com www.moellerchemie.de</p>
bonamain + / bmain + bonatitania clean / btitania clean belgres		Bonasystems italia <p>Bonasystems italia Geal</p>	Bonasystems italia <p>Bonasystems italia Geal</p>	www.bonasystemsitalia.it <p>www.bonasystemsitalia.it www.geal-chim.it</p>

Salvo diversa indicazione di SICHENIA, seguire attentamente le modalità d’uso indicate sulle confezioni dai fabbricanti.

PULIZIA DECORI

Utilizzare detersgenti NEUTRI e diluiti.

NON UTILIZZARE ASSOLUTAMENTE:

Ceranti e/o impregnanti - Detersgenti acidi o alcalini - Paste abrasive - Spazzole o spugne abrasive.

RIMOZIONE DI PATINE LUCIDE

Nei normali detersgenti in commercio sono a volte contenute cere o additivi lucidanti che, lavaggio dopo lavaggio, depositano sul pavimento **patine lucide**, causa di noiose alonature. Patine di questo tipo possono essere depositate anche da alcuni stucchi per le fughe. Semplici alimenti come Coca Cola, vino, acqua, etc., cadendo sul pavimento tolgono questa patina lucida e ripristinano l’**aspetto originale** più opaco delle piastrelle. In mezzo al pavimento più lucido, le zone senza cera appaiono come aloni opachi, in realtà sono le uniche parti pulite del pavimento. In questi casi bisogna:

1. Prima di tutto togliere la patina lucida da tutto il pavimento (vedi tabella seguente);
2. Poi, per le pulizie quotidiane, utilizzare detersgenti neutri che non contengano né cere né patine lucidanti (vedi paragrafo precedente “pulizie quotidiane/ordinarie”).

Pulizia di un pavimento in ceramica con un prodotto a base di acido

RESIDUO DA RIMUOVERE RESIDUES TO BE REMOVED	TIPO DETERGENTE TYPE OF DETERGENT	NOME DETERGENTI DETERGENT’S NAME	PRODUTTORE MANUFACTURER	SITO INTERNET WEBSITE
patine lucide glossy glaze	debolmente acidulo weak acidulous	Tile cleaner (*)	faberchimica	www.faberchimica.com

(*) Non seguire le indicazioni sulla confezione, ma applicare il detergente puro, lasciare agire per 5-10 minuti, frizionare con tamponi morbidi (bianco, giallo) e sciacquare bene con acqua. Non utilizzare cere su gres porcellanato SICHENIA.

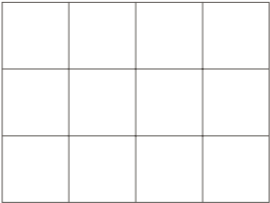
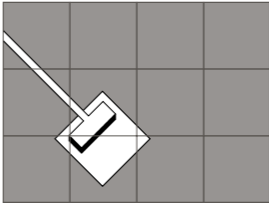
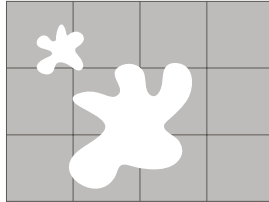
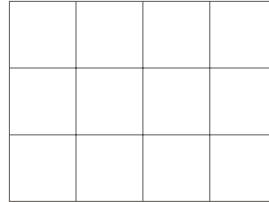
1		2		3		4	
	Pavimento originale. Original floor.		Dopo pulizia con detersgenti contenenti cere. After cleaning detergents containing waxes.		Semplici alimenti (Coca-Cola, vino, acqua..) possono togliere la patina lucida. La superficie originale è più opaca. Simple foodstuffs (Coca-Cola, wine, water etc) can remove the bright patina. The original surface is more matt.		Rimuovere la patina con detergente (pulitore per piastrelle Faber) e utilizzare detergente senza cere per la pulizia quotidiana. Remove the patina with detergent (Faber tile cleaner, used neat), and use detergent without waxes for everyday cleaning.

MANUTENZIONI STRAORDINARIE . SPECIAL MAINTENANCE

Protettivi per fughe . Stain-resistant products for joints

NOME PRODOTTO DETERGENT’S NAME	PRODUTTORE MANUFACTURER	SITO INTERNET WEBSITE
fugaproof	Fila	www.filachim.it
kf fugenschutz	Lithofin	www.lithofin.com

Salvo diversa indicazione di SICHENIA, seguire attentamente le modalità d’uso indicate sulle confezioni dai fabbricanti.

Trattamenti antislip

La resistenza allo scivolamento dei pavimenti posati (sia piastrelle smaltate che non smaltate) può essere aumentata utilizzando specifici prodotti (vedi tabella). Prima di applicare il prodotto sul pavimento fare test preventivi su piastrelle non posate per trovare i tempi di contatto più idonei. Se da un lato tempi più lunghi aumentano il grado di grip, dall’altro tendono un po’ a sbiancare i colori delle piastrelle e a renderle un pochino più sporcabili.

TIPO DI OPERAZIONE TYPE OF OPERATION	NOME PRODOTTO DETERGENT’S NAME	PRODUTTORE MANUFACTURER	SITO INTERNET WEBSITE
trattamento antislip antislip treatment	bonagrip	Bonasystems italia	www.bonasystemsitalia.it
	safe floor	Faberchimica	www.faberchimica.com

attenzione:

1. Non usare questi trattamenti su superfici Lappate né Levigate;
2. Prima del trattamento contattare Servizio Clienti Sichenia;
3. Si consiglia di realizzare il trattamento tramite ditte specializzate.

I prodotti **LEVIGATI** possono raggiungere il grado **R9** (test DIN51130) con appositi trattamenti al laser, eseguibili solo sul materiale non posato: per questo la richiesta di R9 su Levigati deve essere specificata al momento dell’ordine all’ufficio commerciale. Tali trattamenti al laser possono essere seguiti anche su superfici **LAPPATE** (dopo verifica Servizio Clienti SICHENIA).

Pulizia di un pavimento in ceramica con un prodotto a base di acido

DAILY CLEANING:

Use warm water and a good quality microfibre cloth, such as MAGICCLEAN by Bonasystems Italy. Every now and again, e.g. every 10-20 days depending on the state of the flooring, use neutral detergents diluted with hot water, that are wax-free, and do not deposit glossy stains. When the cleaning process in finished always rinse with water, using a second good quality microfibre cloth.

RESIDUO DA RIMUOVERE TYPE OF OPERATION	TIPO DETERGENTE TYPE OF DETERGENT	NOME DETERGENTI DETERGENT’S NAME	PRODUTTORE MANUFACTURER	SITO INTERNET WEBSITE
pulizie quotidiane clean on a daily bas	neutro neutral	tile cleaner <p>fila cleaner pflegereiniger hmk p15</p>	Faberchimica <p>Fila Lithofin Hmk</p>	www.faberchimica.com <p>www.filachim.it www.lithofin.com www.moellerchemie.de</p>
bonamain + / bmain + bonatitania clean / btitania clean belgres		Bonasystems italia <p>Bonasystems italia Geal</p>	Bonasystems italia <p>Bonasystems italia Geal</p>	www.bonasystemsitalia.it <p>www.bonasystemsitalia.it www.geal-chim.it</p>

Unless otherwise indicated by SICHENIA, follow the instructions indicated on the manufacturer’s package very carefully.

CLEANING DECORATIONS

Use NEUTRAL, diluted detergents

NEVER USE:

Waxing and impregnating agents - Acid or alkaline detergents - Abrasive pastes - Abrasive brushes or sponges.

REMOVING GLOSSY GLAZE

Standard detergents that are available in the market sometimes contain waxes or polish additives that, wash after wash, deposit **glossy glaze** on the floor and causes annoying marks. These types of glazes can also settle on some joint grouts.

When simple types of foods such as Coke, wine, water, etc..., fall on the floor, they remove this type of glossy glaze and restore the **original appearance** of the tiles (a more opaque look). In the middle of the shinier floor, the areas without wax appear as opaque marks, but they are actually the only clean parts of the floor. In these cases, the following must be done:

1. First of all, remove the glossy glaze from the entire floor (see table below);
2. Then, for daily cleaning, use neutral detergents that do not contain wax or polishing glaze (see the previous paragraph: “daily/standard cleaning”).

Pulizia di un pavimento in ceramica con un prodotto a base di acido

RESIDUO DA RIMUOVERE RESIDUES TO BE REMOVED	TIPO DETERGENTE TYPE OF DETERGENT	NOME DETERGENTI DETERGENT’S NAME	PRODUTTORE MANUFACTURER	SITO INTERNET WEBSITE
patine lucide glossy glaze	debolmente acidulo weak acidulous	Tile cleaner (*)	faberchimica	www.faberchimica.com

(*) Do not follow the instructions on the package, just apply the pure detergent, leave it on for 5-10 minutes, rub it with soft pads (white, yellow) and rinse it thoroughly with water.

Do not use wax on SICHENIA porcelain stoneware.

INFORMATIONS SUR LE NETTOYAGE ET L’ENTRETIEN

Nettoyage d'un carreau de céramique avec un produit détergent.

Avant de nettoyer une surface carrelée, il est préférable de:

1.Vérifier la **résistance chimique** des carreaux posés sur le catalogue général;
2.Faire un test avant emploi en versant le nettoyant directement sur les carreaux installés et en le laissant agir aussi longtemps que la durée prévue sur le chantier;
3.S'assurer que les nettoyants **ne contiennent** ni acide fluorhydrique ni aucun de ses dérivés, car ces substances particulières entament tous les produits céramiques. Veuillez trouver ci-après quelques instructions pour bien effectuer les nettoyages de fin de chantier (« après pose »), quotidiens, extraordinaires, pour éliminer les cires et les additifs de cirage et pour réaliser toute opération d'entretien extraordinaire.

POURQUOI UN NETTOYAGE « APRÈS POSE »!

1.Le nettoyage « après pose » sert à enlever les résidus de mortier, de ciment, de chaux et de ciment-joint. Il est obligatoire à la fin du chantier, aussi bien pour les carreaux émaillés que pour les carreaux non émaillés.
2.Un mauvais nettoyage « après pose », voire même l'absence de nettoyage, entraîne souvent la formation d'auroles qui compromettent la propreté du revêtement de sol, même après un bon nettoyage quotidien.
3.Chaque fois que possible, notamment pour les surfaces moyennes/grandes, il est recommandé d'avoir recours à une monobrosse munie des disques souples (blancs ou beige).

INSTRUCTIONS DE NETTOYAGE «APRÈS POSE»:

1.Nettoyer 4-5 jours après l'exécution des joints (le mortier doit durcir) et avant 10 jours maximum. Après ce délai, le nettoyage peut demander beaucoup plus d'efforts.
2.Mouiller le revêtement de sol avant les opérations de nettoyage. Ainsi l'eau imprègne les joints et atténue le contact avec les nettoyants.
3.laisser agir les nettoyants peu de temps et bien rincer à l'eau dès que possible.
4.Ne pas faire le nettoyage si les surfaces carrelées sont très chaudes (par ex. exposées au soleil pendant les mois les plus chauds), car la chaleur renforce l'action agressive des produits chimiques. En été, il doit se faire au heures fraîches de la journée.
5.Faire **toujours des tests** avant emploi (sur un carreau non posé), notamment sur les produits Rodés ou Polis.
6.Nettoyage ciments-joints **mélangés avec de l'eau**
Nettoyage avec des nettoyants spéciaux à base d'acides tamponnés et dilués. Veuillez trouver dans le tableau ci-après quelques noms de produits facilement trouvables dans le commerce.

RÉSIDU À ENLEVER <p>ZU ENTFERNENDER REST</p>	TYPE DE NETTOYANT <p>REINIGUNGSMITTEL</p>	NOM DES NETTOYANTS <p>NAME REINIGUNGSMITTEL</p>	FABRICANT <p>HERSTELLER</p>	SITE INTERNET <p>WEBSEITE</p>
ciments-joints . Mortel <p>coulis . Zementschlamm</p> <p>ciment . Zement</p> <p>chaux . Kalk</p>	À base d'acides tamponnés <p>Mit gepufferten Säuren</p>	keranet <p>cement remover</p> <p>deterdeK</p> <p>trek</p> <p>zementschleierentferner</p> <p>hmk r63</p> <p>solvacid</p> <p>bonaclean/bclean</p> <p>bonadecon/bdecon (*)</p>	Mapei <p>Faberchimica</p> <p>Fila</p> <p>Kiter</p> <p>Lithofin</p> <p>Hmk</p> <p>Geal</p> <p>Bonasystems italia</p> <p>www.bonasystemsitalia.it</p>	www.mapei.it <p>www.faberchimica.com</p> <p>www.filachim.it</p> <p>www.kiterdetergenti.it</p> <p>www.lithofin.com</p> <p>www.moellerchemie.de</p> <p>www.geal-chim.it</p> <p>www.bonasystemsitalia.it</p> <p>www.bonasystemsitalia.it</p>

Sauf indication contraire de SICHENIA, suivre avec soin le mode d'emploi signalé par le fabricant sur l'emballage. (*) Spécifique pour produits qui ne sont pas résistant aux acides

7.Nettoyage des joints epoxy, bi-composant et réactif

Nettoyer immédiatement les résidus de manière soignée en se conformant aux indications fournies par le fabricant car ce type de coulis durcit rapidement, même en quelques minutes. Suivez attentivement les indications de nettoyage indiqué par le fabricant de joint utilisé et vérifiez son efficacité (même rétroéclairage) avec un nettoyage préventif avant de jointoyer la totalité du sol / mur.

NOM DES NETTOYANTS . NAME REINIGUNGSMITTEL	FABRICANT . HERSTELLER	SITE INTERNET . WEBSEITE
Epoxy Cleaner	faberchimica	www.faberchimica.com

8.Rutschfeste fliesen

Aufgrund ihrer Beschaff enheit sind die rutschfesten, rauen oder strukturierten Oberflächen etwas schwieriger zu reinigen. Aus diesem Grunde ist die Reinigung sehr wichtig. Für eine schnellere Reinigung wird der Einsatz einer Einscheibenmaschine mit einer weissen oder beige Scheibe empfohlen.

SONDERREINIGUNG

Sie wird ausgeführt, um besonders alte oder hartnäckige Flecken oder Reste zu entfernen. Vor der Anwendung immer Tests vornehmen (auf einer nicht verlegten Fliese), insbesondere bei **geläppten** und **polierten** Fliesen.In der unten aufgeführten Tabelle sind wirksame Reinigungsmittel je nach Fleckenart angegeben.

RÉSIDU À ENLEVER <p>ZU ENTFERNENDER REST</p>	TYPE DE NETTOYANT <p>ART DES REINIGUNGSMITTELS</p>	NOM DES NETTOYANTS <p>NAME REINIGUNGSMITTEL</p>	FABRICANT <p>HERSTELLER</p>	SITE INTERNET <p>WEBSEITE</p>
graisses . Fette <p>dépôts de poussières laissées par le piétinement . Tritstaub</p> <p>grands nettoyages . Grundreinigung</p>	alcalins universels (1) <p>Polyfunktioell, mit Alkalibasis (1)</p>	ps87 <p>intensivreiniger</p> <p>hmk r55</p> <p>taski r20-strip</p> <p>bonadecon / bdecon</p> <p>deterflash</p> <p>Oil & Grease Remover</p> <p>coloured stain remover</p>	Fila <p>Lithofin</p> <p>Hmk</p> <p>Johnsondiversey</p> <p>Bonasystems italia</p> <p>Geal</p> <p>Faberchimica</p> <p>Faberchimica</p>	www.filachim.it <p>www.lithofin.com</p> <p>www.moellerchemie.de</p> <p>www.diverseysolutions.com</p> <p>www.bonasystemsitalia.it</p> <p>www.geal-chim.it</p> <p>www.faberchimica.com</p> <p>www.faberchimica.com</p>
café . Kaffee <p>Coca-Cola . Coca Cola</p> <p>Jus de fruits . Obstsafté</p>	alcalins universels (1) <p>Polyfunktionell, mit Alkalibasis (1)</p>	ps87 <p>super deterjet</p> <p>candeggina</p> <p>oxidant candeggina</p>	Fila <p>Geal</p> <p>vari produttori</p> <p>vari produttori</p>	www.filachim.it <p>www.geal-chim.it</p>
vin . Wein	oxydant . Oxydierend	viakal	Procter & Gamble	it.pg.com
dépôts calcaires . Kalkrückstände	acide (1) . Mit Säurebasis (1)	acido muriatico diluito	vari produttori	
rouille . Rost	acide (1) . Mit Säurebasis (1)	diluente nitro, acqua ragia	vari produttori	
encres feutre . Tinten Filzstift	à base de solvant . Mit Lösungsmittel	coloured stain remover	Faberchimica	www.faberchimica.com
pneus . Reifen <p>traces de caoutchouc . Gummiflecken</p> <p>traces de métaux . Metall</p> <p>traces de crayon . Bleistift</p>	pâte abrasive (1) . scheuermittel (1)	vim clorex (2) <p>polishing cream (2)</p> <p>tile cleaner (3)</p> <p>detergum (3)</p> <p>fuganet</p> <p>fugenreiniger</p>	Guaber <p>Faberchimica</p> <p>Faberchimica</p> <p>Zep Italia</p> <p>Fila</p> <p>Lithofin</p>	www.faberchimica.com <p>www.faberchimica.com</p> <p>www.zep.it</p> <p>www.filachim.it</p> <p>www.lithofin.com</p>
saleté des joints . Fugenschmutz	spécifique . Spezifisch			

(1) Faire des tests avant emploi sur les produits Rodés et Polis. (2) Recommandé pour les produits Rodés et Polis. (3) Ne pas utiliser sur les produits Rodés, utiliser sur les produits polis en faisant très attention. Sauf indication contraire de SICHENIA, suivre avec soin le mode d'emploi signalé par le fabricant sur l'emballage.

INFORMATIONEN ZUR REINIGUNG UND PFLEGE

Nettoyage d'un carreau de céramique avec un produit détergent.

Vor der Reinigung einer gefliesten Fläche wird folgendes empfohlen:

1.Im Hauptkatalog die **Chemikalienbeständigkeit** der verlegten Fliesen prüfen;
2.Einen Vortest direkt auf den verlegten Fliesen vornehmen, indem das zu verwendende Reinigungsmittel über den gleichen Zeitraum wie in der Baustelle mit den Fliesen in Kontakt gebracht wird;
3.Sicherstellen, dass die zu verwendenden Reinigungsmittel **keine** Fluorwasserstoffsäure und/ oder ihre Derivate enthalten, da diese Substanzen durch ihre Besonderheit **alle** keramischen Produkte angreifen. Es folgen einige Angaben zur täglichen, außergewöhnlichen Reinigung am Ende der Bauarbeiten („nach dem Verlegen“), um Wachs und glänzende Schichten zu entfernen und um eventuelle besondere Wartung auszuführen.

WARUM „NACH DEM VERLEGEN“ REINIGUNG!

1.Die Reinigung „nach dem Verlegen“ dient zur Entfernung der Spachtelrückstände, Zementrückstände und Kalkrückstände. Sie ist am Ende der Bauarbeiten für die glasierten und unglasierten Fliesen obligatorisch.
2.Eine schlecht ausgeführte oder eventuell gar nicht ausgeführte Reinigung „nach dem Verlegen“ ist oft die Ursache von Schatten, die trotz einer täglichen Reinigung die Ursache eines nicht sauberen Bodens sind.
3.Wenn möglich – vor allem bei mittel-großen Oberflächen – empfehlen wir die Anwendung eines Einbürstengeräts mit passenden Scheiben weich (weiß oder beige).

ANLEITUNGEN FÜR DIE REINIGUNG „NACH DEM VERLEGEN“:

1.Die Reinigung 4-5 Tage nach der Verlegung (die Fugenmasse muss aushärten) und nicht nach 10 Tagen ausführen. Über diesen Zeitraum hinaus kann die Reinigung sehr schwierig werden.
2.Den Boden vor der Reinigung mit Wasser benetzen. Auf diese Weise werden die Verfugungen mit Wasser benetzt und der Kontakt mit den Reinigungsmitteln reduziert.
3.Die Reinigungsmittel über eine begrenzte Zeit einwirken lassen und sobald wie möglich mit Wasser spülen.
4.Die Reinigung darf nicht ausgeführt werden, wenn die gefliesten Flächen sehr heiß sind (z.B. im Sommer der Sonne ausgesetzt), da die Wirkung der chemischen Substanzen aggressiver ist. Im Sommer wird sie in den kühlen Stunden des Tags ausgeführt.
5.*Vor der Anwendung immer Tests* vornehmen (auf einer nicht verlegten Fliese), insbesondere bei geläppten oder polierten Produkten.
6.Reinigung *von mit wasser gemischten mörtel*
Diese wird mit speziellen Reinigungsmitteln mit gepufferten und verdünnten Säuren ausgeführt. Einige dieser, die im Handel leicht erhältlich sind, sind in der folgenden Tabelle aufgeführt.

RÉSIDU À ENLEVER <p>ZU ENTFERNENDER REST</p>	TYPE DE NETTOYANT <p>ART DES REINIGUNGSMITTELS</p>	NOM DU PRODUIT <p>NAME REINIGUNGSMITTEL</p>	FABRICANT <p>HERSTELLER</p>	SITE INTERNET <p>WEBSEITE</p>
patine lucide <p>Glänzende Schichten</p>	légèrement acide <p>Leicht sauer</p>	Tile cleaner (*)	faberchimica	www.faberchimica.com

Außer bei anders lautenden Angaben von SICHENIA, werden die Gebrauchsanweisungen der Produkthersteller befolgt. (*) Für nicht säurebeständige Produkte geeignet.

7.Reinigung von epoxy-, bi-komponent und aktiven spachtelmassen

In diesen Fällen müssen die Stuckrückstände sofort und sehr sorgfältig unter Beachtung der Angaben des Herstellers erfolgen, weil diese Stücke u.U. sehr schnell in wenigen Minuten härten. Die angegebene Reinigungshinweis vom Hersteller der verwendete Fugenmasse sorgfältig befolgen. Vor dem Verfugen des gesamten Belag (Boden u/o Wand), die Wirkung der Reinigungsempfehlung (auch im Gegenlicht!) mit einem Vor-Test Reinigung überprüfen.

NOM DES NETTOYANTS . NAME REINIGUNGSMITTEL	FABRICANT . HERSTELLER	SITE INTERNET . WEBSEITE
Epoxy Cleaner	faberchimica	www.faberchimica.com

8.Antislip tiles

"Grip" tiles that are made with rough and/or textured surfaces must be cleaned very laboriously. Therefore, it is advisable to clean "after the installation", quickly and thoroughly, using a single-brush machine with disks white and beige.

CLEANING:

This procedure is carried out to remove stains or residues that are particularly old or tough. Make sure to always perform a precautionary test before using the product (on a tile that is not laid), especially for **Lapped** or **Polished** products. The table shown below indicates the detergents that are effective according to the type of stains.

RÉSIDU À ENLEVER <p>ZU ENTFERNENDER REST</p>	TYPE DE NETTOYANT <p>ART DES REINIGUNGSMITTELS</p>	NOM DES NETTOYANTS <p>NAME REINIGUNGSMITTEL</p>	FABRICANT <p>HERSTELLER</p>	SITE INTERNET <p>WEBSEITE</p>
graisses . Fette <p>dépôts de poussières laissées par le piétinement . Tritstaub</p> <p>grands nettoyages . Grundreinigung</p>	alcalins universels (1) <p>Polyfunktionell, mit Alkalibasis (1)</p>	ps87 <p>intensivreiniger</p> <p>hmk r55</p> <p>taski r20-strip</p> <p>bonadecon / bdecon</p> <p>deterflash</p> <p>Oil & Grease Remover</p> <p>coloured stain remover</p>	Fila <p>Lithofin</p> <p>Hmk</p> <p>Johnsondiversey</p> <p>Bonasystems italia</p> <p>Geal</p> <p>Faberchimica</p> <p>Faberchimica</p>	www.filachim.it <p>www.lithofin.com</p> <p>www.moellerchemie.de</p> <p>www.diverseysolutions.com</p> <p>www.bonasystemsitalia.it</p> <p>www.geal-chim.it</p> <p>www.faberchimica.com</p> <p>www.faberchimica.com</p>
café . Kaffee <p>Coca-Cola . Coca Cola</p> <p>Jus de fruits . Obstsafté</p>	alcalins universels (1) <p>Polyfunktionell, mit Alkalibasis (1)</p>	ps87 <p>super deterjet</p> <p>candeggina</p> <p>oxidant candeggina</p>	Fila <p>Geal</p> <p>vari produttori</p> <p>vari produttori</p>	www.filachim.it <p>www.geal-chim.it</p>
vin . Wein	oxydant . Oxydierend	viakal	Procter & Gamble	it.pg.com
dépôts calcaires . Kalkrückstände	acide (1) . Mit Säurebasis (1)	acido muriatico diluito	vari produttori	
rouille . Rost	acide (1) . Mit Säurebasis (1)	diluente nitro, acqua ragia	vari produttori	
encres feutre . Tinten Filzstift	à base de solvant . Mit Lösungsmittel	coloured stain remover	Faberchimica	www.faberchimica.com
pneus . Reifen <p>traces de caoutchouc . Gummiflecken</p> <p>traces de métaux . Metall</p> <p>traces de crayon . Bleistift</p>	pâte abrasive (1) . scheuermittel (1)	vim clorex (2) <p>polishing cream (2)</p> <p>tile cleaner (3)</p> <p>detergum (3)</p> <p>fuganet</p> <p>fugenreiniger</p>	Guaber <p>Faberchimica</p> <p>Faberchimica</p> <p>Zep Italia</p> <p>Fila</p> <p>Lithofin</p>	www.faberchimica.com <p>www.faberchimica.com</p> <p>www.zep.it</p> <p>www.filachim.it</p> <p>www.lithofin.com</p>
saleté des joints . Fugenschmutz	spécifique . Spezifisch			

NETTOYAGE QUOTIDIEN:

Utiliser de l’eau chaude et un chiffon en microfibre de bonne qualité, type MAGICCLEAN de Bonasystems Italia. De temps en temps, tous les 10-20 jours par ex., et selon l’état du sol, utiliser des détergents neutres très dilués dans de l’eau chaude qui ne contiennent pas de cires et ne laissent pas de tâches brillantes. En fin de lavage, rincer toujours à l’eau et à l’aide d’un chiffon en microfibre de bonne qualité.

TYPE D'OPERATION <p>VORGANGSART</p>	TYPE DE NETTOYANT <p>ART DES REINIGUNGSMITTELS</p>	NOM DU PRODUIT <p>NAME REINIGUNGSMITTEL</p>	FABRICANT <p>HERSTELLER</p>	SITE INTERNET <p>WEBSEITE</p>
nettoyages quotidiens <p>Tägliche Reinigung</p>	neutre <p>Neutral</p>	fila cleaner <p>fila cleaner</p> <p>pflegereiniger</p> <p>hmk p15</p> <p>bonamain + / bmain +</p> <p>bonatitania clean / britania clean</p> <p>belgres</p>	Faberchimica <p>Fila</p> <p>Lithofin</p> <p>Hmk</p> <p>Bonasystems italia</p> <p>Bonasystems italia</p> <p>Geal</p>	www.faberchimica.com <p>www.filachim.it</p> <p>www.lithofin.com</p> <p>www.moellerchemie.de</p> <p>www.bonasystemsitalia.it</p> <p>www.bonasystemsitalia.it</p> <p>www.geal-chim.it</p>

Sauf indication contraire de SICHENIA, suivre avec soin le mode d'emploi signalé par le fabricant sur l'emballage.

NETTOYAGE DÉCOR

- utiliser des détergents NEUTRES et dilués.

NE SURTOUT PAS UTILISER: Agents cirants et/ou agents d'imprégnation - Des détergents acides ou alcalins - Des produits abrasifs - Des brosses ou des éponges abrasives.

ÉLIMINATION DES FILMS BRILLANTS

Les nettoyants ordinaires disponibles dans le commerce contiennent souvent des cires ou des additifs de cirage qui, lavage après lavage, déposent sur le revêtement de sol des **films brillants** qui entraînent la formation d'auroles difficiles à éliminer. Des films de ce genre peuvent aussi être occasionnés par certains mortiers. Si des simples boissons, comme le Coca-Cola, le vin, l'eau, etc., sont renversées sur le sol, ce film brillant part et les carreaux reprennent leur **aspect original** plus mat. À côté des carreaux plus brillants, les zones sans cire ont l'air d'être des sortes d'auroles mates, alors qu'en fait, ce sont les seules parties propres du revêtement de sol. Dans ce cas, il faut :

1. avant toute chose, éliminer le film brillant sur l'ensemble du revêtement de sol (voir tableau ci-après) ;
2.ensuite, pour les nettoyages quotidiens, utiliser des nettoyants neutres qui ne contiennent ni cire ni additif de cirage (voir paragraphe précédent « nettoyages quotidiens/ordinaires »).

RÉSIDU À ENLEVER <p>ZU ENTFERNENDER REST</p>	TYPE DE NETTOYANT <p>ART DES REINIGUNGSMITTELS</p>	NOM DU PRODUITS <p>NAME REINIGUNGSMITTEL</p>	FABRICANT <p>HERSTELLER</p>	SITE INTERNET <p>WEBSEITE</p>
patine lucide <p>Glänzende Schichten</p>	légèrement acide <p>Leicht sauer</p>	Tile cleaner (*)	faberchimica	www.faberchimica.com

(*) Ne pas suivre le mode d'emploi signalé sur l'emballage, mais utiliser le nettoyant pur, laisser agir 5-10 minutes, frotter avec des disques tampons doux (blanc, jaune) et bien rincer à l'eau. Nes pas utiliser de cires sur le grès cérame SICHENIA.

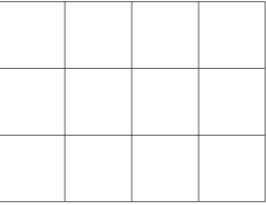
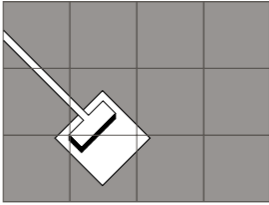
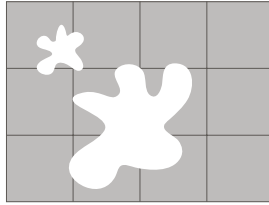
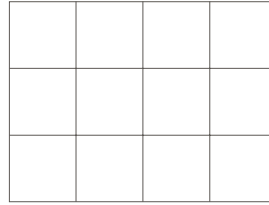
1		2		3		4	
	Sol originel. Originalfußboden.		Après un nettoyage avec détergents contenant de la cire. Nach der Reinigung mit wachshaltigen Reinigungsmitteln.		Certains aliments (Coca-Cola, vin, eau, etc.) peuvent enlever la patine brillante. La surface originale est plus opaque. Normale Lebensmittel (Coca-Cola, Wein, Wasser usw...) können die glänzende Patina entfernen. Die Originaloberfläche ist matter.		Retirer la patine à l'aide d'un déterent (Tile Cleaner pur de Faber) et utiliser chaque jour un détergent sans cire. Die Patina sollte mit Reinigungsmittel entfernt werden (Tile cleaner pur von Faber) und für die tägliche Reinigung sollte ein wachsfreies Reinigungsmittel verwendet werden.

NOM DU PRODUIT <p>PRODUKTNAME</p>	FABRICANT <p>HERSTELLER</p>	SITE INTERNET
fugaproof	fila	www.filachim.it
kf fugenschutz	lithofin	www.lithofin.com

Sauf indication contraire de SICHENIA, suivre avec soin le mode d'emploi signalé par le fabricant sur l'emballage.

NOM DU PRODUIT <p>PRODUKTNAME</p>	FABRICANT <p>HERSTELLER</p>	SITE INTERNET
fugaproof	fila	www.filachim.it
kf fugenschutz	lithofin	www.lithofin.com

Außer bei anders lautender Angabe de SICHENIA, suivre avec soin le mode d'emploi signalé par le fabricant sur l'emballage.

Traitements antidérapantes

La résistance au glissement des carrelages posés (aussi bien des carreaux émaillés que des carreaux non émaillés) peut être améliorée avec des produits spécifiques (voir tableau). Avant d'appliquer le produit sur le revêtement de sol, faire toujours des tests sur les carreaux non posés pour déterminer les temps de pose plus indiqués. Si d'un côté, les longs temps de pose augmentent le coefficient de frottement, de l'autre, ils ont tendance à décolorer un peu les carreaux et à les salir plus vite.

TIPO DI OPERAZIONE <p>TYPE OF OPERATION</p>	NOME PRODOTTO <p>DETERGENT'S NAME</p>	PRODUTTORE <p>MANUFACTURER</p>	SITO INTERNET <p>WEBSITE</p>
trattamento antislip <p>antislip treatment</p>	bonagrip	Bonasystems italia	www.bonasystemsitalia.it
	safe floor	Faberchimica	www.faberchimica.com

Attention:

1. Ne pas faire ces traitements sur les surfaces Rodées ou Polies ;
2. Avant le traitement, contacter le Service Clients Sichenia ;
3. Il est recommandé de confier le traitement à des entreprises spécialisées.

Les produits **POLIS** peuvent atteindre un niveau d'adhérence **R9** (essai DIN 51130) par le biais de traitements laser ; ceux-ci ne peuvent être effectués que sur les produits non posés. Pour les carreaux Polis, le client est donc tenu de spécifier le niveau R9 au service commercial lors de la commande. Ces traitements laser peuvent aussi être effectués sur les surfaces **RODÉES** (après vérification auprès du Service Clients SICHENIA).

Nettoyage d'un carreau de céramique avec un produit détergent.

TÄGLICHE / REGELMÄSSIGE REINIGUNG

Warmes Wasser und ein hochwertiges Mikrofaseretuch vom Typ MAGICCLEAN von Bonasystems Italia verwenden. Ab und zu, zum Beispiel alle 10-20 Tage, je nach Zustand des Fußbodenbelags, neutrale in warmen Wasser verdünnte Reinigungsmittel verwenden, die wachsfrei sind und keine glänzenden Schmierfilme hinterlassen. Nach dem Reinigen immer mit Wasser nachspülen und dafür ein zweites hochwertiges Mikrofaseretuch verwenden.

TYPE D'OPERATION <p>VORGANGSART</p>	TYPE DE NETTOYANT <p>ART DES REINIGUNGSMITTELS</p>	NOM DU PRODUIT <p>NAME REINIGUNGSMITTEL</p>	FABRICANT <p>HERSTELLER</p>	SITE INTERNET <p>WEBSEITE</p>
nettoyages quotidiens <p>Tägliche Reinigung</p>	neutre <p>Neutral</p>	fila cleaner <p>fila cleaner</p> <p>pflegereiniger</p> <p>hmk p15</p> <p>bonamain + / bmain +</p> <p>bonatitania clean / britania clean</p> <p>belgres</p>	Faberchimica <p>Fila</p> <p>Lithofin</p> <p>Hmk</p> <p>Bonasystems italia</p> <p>Bonasystems italia</p> <p>Geal</p>	www.faberchimica.com <p>www.filachim.it</p> <p>www.lithofin.com</p> <p>www.moellerchemie.de</p> <p>www.bonasystemsitalia.it</p> <p>www.bonasystemsitalia.it</p> <p>www.geal-chim.it</p>

Außer bei anders lautender Angabe durch SICHENIA, die Gebrauchsanleitungen der Hersteller befolgen.

REINIGUNG DES FLIESENDEKORS

- Verwenden Sie ausschließlich NEUTRALE und verdünnte Reinigungsmittel.

VERWENDEN SIE AUF KEINEN FALL: Wachs- und/oder Imprägniermittel - Ätzende oder alkalische Reinigungsmittel - Scheuerpasten-und Pulver - Grobe Bürsten oder abrasive Schwämme.

ENTFERNEN VON GLÄNZENDEN SCHICHTEN

In den normalen handelsüblichen Reinigungsmitteln sind manchmal Wachse oder glänzende Zusätze enthalten, die nach jeder Reinigung **glänzende** Schichten auf dem Boden hinterlassen, die hartnäckige Streifen verursachen. Schichten dieser Art können auch von einiger Fugenmassen hinterlassen werden. Einfache Lebensmittel wie Coca Cola, Wein, Wasser usw. entfernen durch Fallen auf den Boden diese glänzende Schicht und bringen den matten **Originalzustand** der Fliesen wieder zum Erscheinen. Auf dem glänzenden Teil des Bodens erscheinen die Bereiche ohne Wachs als matte Schatten, eigentlich handelt es sich um die einzigen sauberen Bereiche des Bodens. In diesen Fällen muss man:

1.Zuerst die glänzende Schicht vom ganzen Boden entfernen (siehe folgende Tabelle);
2.Dann zur täglichen Reinigung neutrale Reinigungsmittel verwenden, die keine Wachse oder glänzende Zusätze enthalten (siehe vorheriger Abschnitt „tägliche/regelmäßige Reinigung“).

RÉSIDU À ENLEVER <p>ZU ENTFERNENDER REST</p>	TYPE DE NETTOYANT <p>ART DES REINIGUNGSMITTELS</p>	NOM DU PRODUITS <p>NAME REINIGUNGSMITTEL</p>	FABRICANT <p>HERSTELLER</p>	SITE INTERNET <p>WEBSEITE</p>
patine lucide <p>Glänzende Schichten</p>	légèrement acide <p>Leicht sauer</p>	Tile cleaner (*)	faberchimica	www.faberchimica.com

(*) Die Angaben auf der Verpackung nicht befolgen, sondern das Reinigungsmittel pur anwenden, 5-10 Minuten einwirken lassen, mit weichen Kissen abreiben (weiß, gelb) und gut mit Wasser abspülen. Keine Wachse auf Feinsteinzeug von SICHENIA verwenden.

Condizioni generali di vendita e garanzie

1. NORMATIVA CONTRATTUALE

Le presenti condizioni generali costituiscono parte integrante di tutti i contratti di vendita di cui sia parte Sichenia Gruppo Ceramiche S.p.A.. Salvo singoli casi in cui esse siano state derogate con espresse pattuizioni scritte a firma Sichenia Gruppo Ceramiche S.p.A. (qui di seguito denominata Venditore) costituiranno la disciplina esclusiva di tali vendite.

Se una o più parti delle presenti condizioni o dei singoli contratti che le includano risultassero invalide, le condizioni generali o particolari resteranno valide nel loro complesso; le parti invalide saranno sostituite con pattuizioni che si avvicinano quanto possibile alla originaria volontà delle parti. Ogni offerta, ogni accettazione d'ordine ed ogni consegna da parte del Venditore si intende fatta alle presenti condizioni salvo espresa deroga scritta a firma del Venditore stesso; l'accettazione di tali offerte e la presa in consegna di prodotti provenienti dal Venditore implica pertanto l'accettazione da parte degli acquirenti delle presenti condizioni integrate dalle eventuali pattuizioni scritte tra le parti. La vendita si intende conclusa nel momento in cui il proponente o l'ordinante vengono a personale conoscenza del consenso della controparte; nel caso in cui tale consenso non sia stato espresso per iscritto potranno tener luogo della comunicazione scritta di consenso esclusivamente le comunicazioni scritte di avviso di merce pronta o, in mancanza, di spedizione della merce all'ordinante, o infine, in mancanza, la avvenuta prima consegna dei prodotti all'ordinante e/o al suo trasportatore. L'esecuzione del contratto di vendita è in ogni caso convenzionalmente stabilita aver luogo nella sede del Venditore.

2. OGGETTO DELLA FORNITURA E CONFERMA D'ORDINE

La fornitura comprende solamente le prestazioni, i materiali ed i quantitativi specificati nella nostra conferma d'ordine o in altre comunicazioni scritte da noi provenienti. Il testo della nostra conferma d'ordine prevarrà in ogni caso sul testo difforme dell'eventuale offerta o dell'ordinazione. L'ordine non confermato per iscritto in nessun caso potrà intendersi accettato salvo esecuzione del medesimo da parte nostra mediante comunicazione scritta di merce pronta, di spedizione o mediante consegna dei prodotti.

L'esecuzione parziale dell'ordine senza preventiva conferma, non significa nostra approvazione per l'intero ordine, bensì approvazione parziale relativamente alla merce consegnata. In questo caso la consegna della merce al vettore equivarrà ad accettazione da parte dell'acquirente della nuova proposta contrattuale.

3. CONSEGNA

La consegna si intende eseguita presso il ns. stabilimento di Sassuolo. La merce viaggia sempre a rischio e pericolo del compratore anche se spedita franco diporto. Sono quindi a carico del compratore anche i rischi di eventuali rotture e/o manomissioni o deterioramenti.

La consegna dei prodotti ha luogo secondo la formula “Franco fabbrica Venditore”; tale formula, come anche le formule di resa che fossero convenute per iscritto in alternativa ad essa, fanno riferimento agli “Incoterms” della Camera di Commercio internazionale, nell'edizione vigente al momento della vendita.

Nel caso in cui Venditore e acquirente convenissero per iscritto che la resa dei prodotti abbia luogo “F.O.B. porto italiano”, resta inteso che la scelta della nave e del porto italiano di partenza sarà a cura del VENDITORE che agirà per conto dell'acquirente.

Merci ordinate dal committente per errore o ordinate in eccedenza da parte del committente come pure di rimanenza, non vengono ritirati da parte della ns. società.

Misure, pesi e caratteristiche indicate nei nostri listini debbono intendersi indicativi.

290

4. TERMINI DI CONSEGNA

Il termine stabilito per la consegna della merce deve intendersi a favore di entrambi i contraenti. I termini di consegna sono solamente indicativi e non perentori. Eventuali ritardi derivanti da qualsiasi causa non danno mai diritto al compratore ad annullare ordini o pretendere risarcimento di eventuali danni diretti o indiretti. Il Venditore si riserva espressamente di poter eseguire consegne parziali a fronte di ciascun ordine. Quando siano intervenute modificazioni al contratto, il termine è prorogato per un periodo uguale a quello inizialmente stabilito.

In caso di ritardo nelle consegne l'acquirente potrà, dopo una rituale messa in mora, ricusare ulteriori consegne e recedere dal contratto per la parte dei prodotti non ancora consegnata. Il recesso dal contratto per la parte non consegnata a cagione di ritardo dà luogo al pagamento dei soli prodotti effettivamente consegnati escluso ogni ulteriore risarcimento o indennizzo.

5. FORZA MAGGIORE

Il Venditore non è responsabile nei confronti dell'acquirente per ogni inadempimento, compresa la mancata o ritardata consegna, causato da accadimenti al di fuori del suo ragionevole controllo quali, a titolo meramente indicativo, mancata o ritardata consegna dei materiali di lavorazione da parte dei fornitori, guasti agli impianti, scioperi e altre azioni sindacali, interruzione dei flussi energetici, sospensione o difficoltà nei trasporti.

Ogni evento di forza maggiore sospende la decorrenza del termine per tutta la sua durata. Se, in conseguenza di eventi di forza maggiore, il contratto non potrà trovare esecuzione entro i 60 giorni successivi al termine convenuto, ognuna delle due parti avrà la facoltà di recedere dal contratto stesso. In tal caso la dichiarazione di recesso dovrà essere spedita alla controparte, a mezzo lettera raccomandata con ricevuta di ritorno entro i 10 giorni successivi allo scadere dei predetti 60 giorni, restando esclusi i reciproci diritti a indennizzi od a risarcimenti.

6. PREZZI E TERMINI DI PAGAMENTI

I prezzi dei prodotti indicati nei cataloghi vigenti sono EXW (Franco Fabbrica); ne consegue che qualsiasi altro onere o spesa relativi a spedizione, consegna e/o trasporto dei prodotti sono a esclusivo carico dell'acquirente. I prezzi si intendono al netto di IVA di legge, che deve essere corrisposta in conformità a quanto indicato in fattura. Il luogo di pagamento è fissato presso la nostra Sede Amministrativa in Sassuolo (MO), anche nel caso di emissione di tratte, ricevute bancarie, LCR, ovvero di rilascio di effetti cambiari: eventuale deroga a quanto sopra sarà valida soltanto se da noi concessa in forma scritta.

Il ritardo del pagamento, anche parziale, delle nostre fatture oltre la pattuita scadenza, darà luogo come previsto per legge all'automatica decorrenza degli interessi di mora, calcolati in conformità a quanto previsto dal D.Lgs n. 231 del 2002. Inoltre il mancato o ritardato pagamento anche parziale delle fatture - per qualsivoglia ragione - darà diritto al Venditore, impegnata ogni altra iniziativa, di pretendere il pagamento anticipato delle restanti forniture. Il mancato o ritardato pagamento, anche parziale, del prezzo o del corrispettivo nei termini pattuiti, l'assoggettamento dell'acquirente a procedure esecutive, concorsuali o di liquidazione, le mutate condizioni patrimoniali dell'acquirente che siano tali da far ragionevolmente presumere lo stato di crisi, sono causa di risoluzione ex. art. 1456 cod. civ. del contratto di compravendita e giustificata in ogni caso, ex art. 1460 del Cod. Civ., il rifiuto di adempiere eventuali ulteriori obbligazioni contrattuali e di annullare l'evazione di eventuali altri ordini in corso, senza che il compratore possa avanzare pretese di compensi, indennizzi od altro. Per la fatturazione valgono i prezzi di listino in vigore al giorno della consegna. In caso di un cambiamento dei prezzi tra la conferma d'ordine ed il giorno della fornitura, il Venditore ha il diritto di adeguare i prezzi pattuiti alla nuova situazione.

7. SOLVE ET REPETE

Nessuna eccezione, salvo quelle di nullità, annullabilità e rescissione del contratto, può essere opposta dall'acquirente, al fine di ritardare od evitare il pagamento.

8. RISERVA DI PROPRIETÀ

Nel caso in cui il pagamento, per accordi contrattuali, debba essere effettuato - in tutto o in parte - dopo la consegna, i prodotti consegnati restano di proprietà del Venditore fino all'integrale pagamento del prezzo.

La merce oggetto di riserva di proprietà dovrà essere, a cura dell'acquirente, tenuta fisicamente da parte e individuata come proprietà del Venditore.

L'acquirente non potrà vendere fuori dai suoi normali rapporti commerciali, ne consegnare a terzi, dare in pegno e comunque disporre dei prodotti oggetto di riserva di proprietà del Venditore; dovrà inoltre informare tempestivamente il Venditore di ogni diritto che i terzi possano aver acquisito sulla merce stessa.

In caso di mora dell'acquirente il Venditore potrà, senza necessità di alcuna formalità, compresa la messa in mora, ritirare tutta la merce oggetto di riserva di proprietà, con riserva di ogni ulteriore opportuno rimedio in via giudiziale per il pregiudizio subito.

9. GARANZIA

I nostri materiali sono garantiti conformi alle Norme UNI-DIN-EN attualmente in vigore.

La nostra garanzia è limitata ai materiali di prima scelta. Qualsiasi garanzia per vizi è quindi espressamente esclusa per i materiali di seconda e di terza scelta o di stock e per le partite occasionali. Tali materiali sono venduti come “visti e graditi”.

I materiali in 1° scelta vengono garantiti conformi alle Norme ISO vigenti al momento della vendita con una tolleranza del 5% (cinque per cento); per quanto ivi non espressamente stabilito, vengono venduti con riferimento alle regole dell'arte ed alle consuetudini comunemente in uso nel settore ceramico ed ai consigli di utilizzo riportati nel ns. catalogo generale. Condizione indispensabile per la validità ed efficacia delle garanzie è il rispetto delle norme di posa DIN 18352.

Eventuali reclami e contestazioni dovranno essere denunciati, a pena di decadenza, a mezzo lettera raccomandata, unicamente presso la nostra Sede Amministrativa in Sassuolo (MO), prima della posa in opera del materiale e comunque entro il termine perentorio di 8 giorni dalla ricezione del materiale e in ogni caso prima della sua successiva vendita a terzi. La posa in opera del materiale determina la decadenza dall'azione per vizi tanto palesi che occulti, importando rinuncia implicita alla garanzia di cui all'art. 1490 c.c.

Le illustrazioni e le descrizioni dei cataloghi e dei listini, tutte le nostre pubblicazioni ed i campionari non sono impegnativi ma puramente indicativi. Le dimensioni dei prodotti soggetti a calibro, in particolare dei pavimenti in porcellana dura smaltata e gres-porcellanato, sono da intendersi con le tolleranze d'uso. Le tonalità dei materiali s'intendono sempre approssimative e le eventuali differenze di tonalità non costituiscono difetto del materiale e non possono essere denunciate come tali.

Qualora il reclamo sia tempestivo e risulti fondato, l'obbligazione del Venditore è limitata alla accettazione in restituzione ed alla conseguente sostituzione della merce viziata o difettosa nel luogo stesso della fornitura primitiva, restando tassativamente rinunciati ed esclusi così la risoluzione del contratto come qualsiasi riduzione prezzo o risarcimento danni.

La responsabilità e la garanzia non si estendono in alcun modo ai materiali già posti in opera. La sostituzione del materiale oggetto della contestazione non avrà luogo ove il compratore non ne abbia sospeso immediatamente l'impiego al momento della scoperta. Eventuali contestazioni sul materiale non daranno diritto all'Acquirente di sospendere o ritardare in tutto o in parte il pagamento nei termini pattuiti, ai sensi del precedente articolo 7.

10. CONTESTAZIONI

Le contestazioni per la merce mancante devono essere sollevate all'atto del ricevimento. Sono altresì da comunicare all'atto del ricevimento eventuali contestazioni per merce fornita in difformità a quanto convenuto.Consegne di merce spedita sono, in ogni caso, da accettare da parte del committente. Consegne contenenti materiale contestato e/o materiale da rendere devono essere dal compratore immagazzinate in modo adeguato e al riparo da eventuali danni.

La garanzia per difetti occulti rimane esclusa o limitata nel caso di: rimozione non autorizzata dell'opera, posa non effettuata a regola d'arte, inosservanza di nostre prescrizioni e particolari direttive di applicazione atti del danneggiamento non ispirati alla normale diligenza che abbiano pregiudicato il contenimento dei danni. L'utilizzo di merce visibilmente difettosa o difforme all'ordinato implica accettazione delle caratteristiche di qualità ed esclude ogni eventuale contestazione.

Per ogni indennizzo è obbligatoria la comprovazione che la merce sia stata trattata in modo adeguato e posata a regola d'arte.

E' imprescindibile, in ogni caso, che ci sia data la possibilità di controllare i difetti contestati nel loro stato originale. In questo caso deve essere concesso un sufficiente termine di tempo per la constatazione della causa del danno. Se questo diritto dovesse essere negato da parte del compratore decliniamo ogni responsabilità per l'indennizzo.

Il danneggiato ha l'obbligo di prendere tutte le misure necessarie allo scopo di contenere i danni al minimo. Inoltre deve assicurare un sufficiente numero di campioni della merce contestata.

I reclami riflettenti difetti riscontrati nei pezzi di una fornitura non infrmano la validità della stessa, ma restano limitati ai pezzi risultati difettosi.

Il venditore non è tenuto a risarcire danni diretti ed indiretti di qualsiasi natura derivati al compratore dall'impiego o dal mancato impiego del materiale difettoso.

Qualsiasi reclamo o contestazione non implica la sospensione od il rifiuto al pagamento delle fatture, pagamento che dovrà effettuarsi regolarmente ed integralmente nei termini convenuti.

11. DIVIETO D'ESPORTAZIONE

Salvo accordi in contrario, è fatto divieto all'Acquirente di esportare i nostri materiali a lui forniti, o di cederli a Ditte o persone che ne facciano oggetto di esportazione.

12. MODIFICHE ED INTEGRAZIONI

I contratti di vendita regolati dalle presenti condizioni generali possono essere modificati solo mediante un documento o comunicazione scritta, firmati dai legali rappresentanti delle parti.

13. LEGGE APPLICABILE E FORO COMPETENTE

Le presenti Condizioni di Vendita e ciascun contratto stipulato tra Venditore ed acquirente, ivi compresi i contratti di vendita all'esportazione, sono regolati dalla legge Italiana.

Foro competente per tutte le controversie relative alle vendite di prodotti da parte del Venditore e dei rapporti connessi a tali vendite è esclusivamente quello di Modena.

14. EFFETTIVITA' DI CIASCUNA CONDIZIONE

Le condizioni generali di vendita sopra riportate non devono assolutamente intendersi come clausole di puro stile. Esse sono effettive e rappresentano fedelmente la volontà negoziale delle parti e costituiscono il frutto di attenta e specifica negoziazione.

15. ANNULLAMENTO ORDINI E RESI

Per l'annullamento autorizzato di ordini di materiali già consegnati al nostro deposito e per resi autorizzati, verrà addebitato il 15% del valore imponibile, con fisso minimo di 20€, per contributo spese di trasporto e riselezione.

16. ORDINI MINIMI

Per ordini inferiori ai 10 colli (a “completamento” e ad “evasione singola”), verrà applicata una maggiorazione fissa di 20€.

General sales conditions and guarantees.

1. GENERAL TERMS OF AGREEMENT

These general terms and conditions form an integral part of all sales agreements in which Sichenia Gruppo Ceramiche S.p.A. is a party.

With the exception of single cases, in which the said conditions have been waived with express written agreements signed by Sichenia Gruppo Ceramiche S.p.A, (hereinafter referred to as Seller), they shall govern said sales.

If one or more parts of these conditions, or of the single agreements that include them, shall be deemed invalid, the general or specific conditions shall remain valid as a whole; the invalid parts shall be replaced by agreements that shall be as close as possible to the original intent of the parties. Each offer, each order acceptance and each delivery by the Seller is understood to be made at the conditions herein, unless otherwise agreed and signed in writing by the Seller; the acceptance of the said offers and the acceptance of the products delivered by the Seller implies the acceptance by the buyer of these conditions, which may be supplemented with written agreements between the parties.

The sale is deemed completed when the proposing party or the ordering party personally gain knowledge of the counterparty's consent; if the consent is not expressed in writing, only the following documents may replace it: written communication notifying that the goods are ready or, failing this, that they have been shipped to the ordering party, or finally, failing this, the first delivery to the ordering party and/or forwarding agent.

It is hereby established that the sales agreement shall, in any case, be executed at the Seller's headquarters.

2. SCOPE OF THE SUPPLY AGREEMENT AND ORDER CONFIRMATION

The supply comprises solely the services, materials, and quantities specified in the Seller's order confirmation or in any other written notification sent by the latter. In the event of discrepancies between the wording of the offer or the order and the wording of the order confirmation, the latter shall prevail.

If an order is not confirmed in writing, it shall not be considered accepted, unless it is processed by the Seller and notified by means of a goods ready or shipment communication or by delivery of the products.

Partial processing of the order without prior confirmation shall not constitute the Seller's approval of the entire order, but simply partial approval relating to the goods delivered. In this case, delivery of the goods to the carrier shall constitute acceptance by the buyer of the new agreement proposal.

3. DELIVERIES

Deliveries shall be at the Seller's factory in Sassuolo. The goods always travel at the buyer's risk and peril, even if delivered carriage free. The buyer shall therefore also be responsible for the risk of any breakage and/or tampering or wear and tear.

The products are delivered “Ex works Seller”; this term, like any other alternative delivery term that may be agreed, refers to the “Incoterms” set out by the International Chamber of Commerce, in the version in force at the time of the sale.

If the Seller and buyer agree that the delivery shall be “F.O.B. Italian port”, it is understood that the Seller shall choose the ship and the Italian port of departure on behalf of the buyer.

The Seller shall not take back any goods ordered by mistake or in excess by the buyer or that the buyer has in stock.

Sizes, weights and characteristics stated in the Seller's price lists are understood to be indicative.

4. DELIVERY TERMS

The term established for the delivery of the goods must be suitable for both parties. Delivery terms are only approximate and not binding. Any delay, for whatever reason shall not give the buyer the right to cancel orders or claim compensation for any direct or indirect damage. The Seller expressly reserves the right to deliver every order partially.

If the agreement is amended, the term shall be extended by the same amount as that originally established.

In the event of delays in the deliveries, the buyer may, following a standard formal notice, refuse further deliveries and withdraw from the agreement for the part of the products not yet delivered. The withdrawal from the agreement, for the part of the products not delivered due to a delay, shall result in the payment only of the products actually delivered, excluding any further compensation or indemnity.

5. FORCE MAJEURE

The Seller is not liable to the buyer for any non fulfilment, including the non-delivery or delayed delivery, caused by events beyond its reasonable control such as, merely as an example, non-delivery or delayed delivery of the raw materials by the suppliers, plant failures, strikes and other union actions, power interruption, suspended transport or transport problems.

Any events of force majeure shall interrupt the term for the duration of the said event. If, following force majeure events, the agreement cannot be performed within 60 days following the agreed term, each party shall have the right to withdraw from the said agreement. In this case, the withdrawal communication must be sent to the other party by recorded delivery letter with advice of receipt within the 10 days following the expiry of the aforementioned 60 days, any mutual rights to indemnity or compensation being hereby excluded.

6. PRICES AND PAYMENT TERMS

The prices of the products shown in the current catalogues are EXW (ex works); any other costs or charges concerning the shipment, delivery and/or transport of the products shall be borne solely by the buyer. The prices are net of VAT required by law, which must be paid according to the invoice. The place of payment is hereby established as the Seller's administrative premises in Sassuolo (Modena), even in the event of issue of bank drafts or direct debits, LCR or bills of exchange: any exception to the foregoing shall be valid solely if granted by the Seller in writing.

Any delays in the payment, even partial, of invoices beyond the agreed expiry date shall result in the immediate application of the interest on arrears envisaged by law, calculated according to Legislative decree no. 231 of 2002. Furthermore, failure to pay or delays in payment of the invoices, even partly – for whatsoever reason it may occur - shall entitle the Seller to claim the early payment of the other supplies, without prejudice to any further action it may deem appropriate. If the buyer fails to pay within the terms agreed or delays the payment of the prices or amount agreed, even partly, or if the buyer is subjected to enforcement actions, insolvency or liquidation proceedings or if its financial situation changes in a way that reasonably suggests a financial crisis, these shall constitute grounds for termination of the agreement concerned, pursuant to Article 1456 of the Italian Civil Code, and shall validate – pursuant to Article 1460 of the Italian Civil Code - in any case - the refusal to fulfil further contractual obligations and to cancel the processing of any other pending orders, and the buyer shall not be entitled to file any claims for compensation, indemnity or similar.

Invoices shall be issued at the prices of the price list in force at the time of the delivery. If the prices change in the time between the order confirmation and the day of the supply, the Seller has the right to adjust the prices agreed upon to the new conditions.

7. SOLVE ET REPETE (PAY AND THEN CLAIM)

With the exception of the voidness, voidability of the agreement or withdrawal therefrom, no objections shall be raised by the buyer in order to delay or avoid payment.

8. RETENTION OF TITLE

In the event that, due to contractual arrangements, payment is required - either in full or in part - after delivery, the products delivered shall remain property of the Seller until the payment in full of the price thereof.

Under this clause, the buyer must keep any goods that are property of the Seller separate from other goods and identify them as such.

The buyer shall not sell outside its normal commercial business, or deliver to third parties or pledge or use in any way the products for which the Seller retains the title; the buyer must also immediately inform the Seller of any rights that third parties may have acquired on the goods.

In the event of payment in arrears by the buyer, the Seller shall have the right, without any formality – including formal notice – to take back all the goods for which it retains title, with the right to claim any further appropriate remedy, by legal means, for the loss suffered.

9. WARRANTY

The Seller's products are guaranteed in compliance with UNI-DIN-EN standards currently in force. The Seller's guarantee only covers first-class products. Any guarantee concerning faults is therefore expressly excluded for second and third-class materials or old stock materials and for any occasional batches. The said goods are sold as “seen and accepted”.

First-class products are guaranteed to comply with the ISO regulations in force at the time of sale, with a tolerance of 5% (five per cent); for all matters not expressly provided herein, the products sold comply with the professional and customary standards in use in the ceramic tile sector and for the use suggested in the general catalogue.

For the warranties to be valid and implemented, abidance by the laying standards envisaged by DIN 18352 is essential.

For any claims and disputes to be taken into account, the buyer is required to inform the Seller thereof via recorded delivery letter, sent solely to the Seller's administrative premises in Sassuolo (MO), before laying the material and, in any case, within the binding term of 8 days from receipt of the material and in any case prior to the subsequent resale thereof to third parties. Laying the material shall result in the forfeiture of the right to take action for obvious and hidden defects, and thus in the implicit waiver of the warranty envisaged in Article 1490 of the Italian Civil Code.

The illustrations and descriptions in the catalogues and price lists, all the Seller's publications and sample collections are merely indicative and not binding. The dimensions of the sized products, in particular of hard-paste glazed porcelain and porcelain stoneware floor tiles, foresee use tolerances. The shades of the products are always understood to be approximate and any differences are not a fault of the materials and therefore cannot be claimed as such.

If the claim is timely and found to be justified, the Seller is only obliged to accept the return and replace the faulty or defective goods and send them to the same place as the original supply, being waived and excluded hereof the right to terminate the contract as well as the right to any price reduction or compensation for damages.

Liability and the warranty do not cover in any way the materials already fitted.

The material subject matter of the claim shall not be replaced if the buyer does not immediately suspend its use upon discovery of the fault in question.

Any disputes concerning the material shall not entitle the buyer to withhold or delay payment of the amount due, or part thereof, within the terms agreed, pursuant to Article 7 hereinabove.

10. CLAIMS

Claims for missing goods must be made upon receipt thereof. Any claims for the delivery of goods non-compliant with what has been agreed must also be made upon receipt thereof.

The buyer must in any case accept the goods sent. Deliveries of disputed goods and/or material to be returned must be appropriately stored by the buyer, protected from damage.

The warranty for hidden defects remains excluded or limited in the event of: unauthorised removal of the fitted products, unprofessional laying of the product, non-compliance with the Seller's instructions and specific directives, damaging actions due to failure to comply with standard diligence, which may have prejudiced damage control. The use of visibly faulty goods or goods visibly non-compliant with those ordered implies the acceptance of the quality characteristics and excludes the right to make any claim.

For the claim to be accepted, proof must be supplied that the goods have been treated in an adequate manner and laid according to professional standards.

In any case, it is essential that the Seller has the possibility to check the faults claimed in their original state. In this case, sufficient time must be granted to check the cause of the damage. If the buyer denies this right, the Seller declines any liability for compensation.

The damaged party must take all the measures possible to contain the damage to a minimum. In addition, the said party must provide a sufficient number of samples of the disputed goods.

Claims concerning defects found in pieces part of a supply do not lessen the validity thereof, and shall be restricted to the defective pieces.

The seller is not obliged to compensate direct and indirect damages of any kind suffered by the buyer from the use or non-use of the defective material.

Any claim or dispute shall not imply the suspension or refusal of the payment of the invoices; the payment must be made in full within the terms agreed.

11. NO EXPORTING

Unless agreed otherwise, the buyer is forbidden to export the products supplied by the Seller, or to transfer them to companies or people that will export them.

12. AMENDMENTS AND SUPPLEMENTS

The sales agreements governed by these general conditions may only be amended by a written document or communication signed by the legal representatives of the parties.

13. APPLICABLE LAW AND COMPETENT AUTHORITY

These sales conditions and each agreement entered into by the Seller and buyer, including export sales agreements, are governed by Italian law.

For all disputes concerning the sale of products by the Seller and relations connected to said sales, the court of Modena is the sole competent authority.

14. EFFECTIVENESS OF EACH CONDITION

The general conditions of sale set out hereinabove shall not be considered merely formalities. They are both valid and faithfully representative of the contractual intent of the parties and are the result of a careful and specific negotiation.

15. CANCELLATION OF ORDERS

For the authorized cancellation of orders for materials already delivered to our warehouse and for authorized returns of the goods, 15% of the taxable value will be charged, with a minimum fixed contribution of 20€ towards transport and reselection costs.

16. MINIMUM ORDERS QUANTITIES

For single or additional small orders of less than 10 boxes, a fixed fee of 20€ will be applied.

Conditions générales de vente

Conditions générales de vente et garanties

1. DISPOSITIONS CONTRACTUELLES

Les présentes conditions générales font partie intégrante de tous les contrats de vente dont Sichenia Gruppo Ceramiche S.p.A. est partie prenante.

Sauf cas particuliers de dérogation de ces conditions établie par écrit par Sichenia Gruppo Ceramiche S.p.A. (plus bas, le Vendeur), elles sont les seules conditions à régler ces ventes. Dans le cas où une ou plusieurs parties de ces conditions ou des contrats seraient invalidées, les conditions générales ou particulières restent valables dans leur ensemble ; les parties invalidées seront dans ce cas remplacées par des accords exprimant au plus près la volonté initiale des parties. Chaque offre, chaque acceptation de commande et chaque livraison de la part du Vendeur doivent s’entendre effectuées aux présentes conditions sauf dérogation expresse établie par écrit par le Vendeur ; l’acceptation de ces offres et l’acceptation des produits livrés par le Vendeur impliquent conséquemment l’acceptation des présentes conditions accompagnées d’éventuelles conditions complémentaires établies par écrit par les parties. La vente s’entend conclue dès l’instant où le soumissionnaire ou le donneur d’ordre est informé de l’acceptation de la part de l’autre partie ; dans le cas où cette acceptation ne serait pas exprimée par écrit, pourront exclusivement en tenir lieu les communications écrites de notification de « merchandise prête » ou, à défaut, d’expédition de la marchandise au donneur d’ordre ou enfin, à défaut, la première livraison au donneur d’ordre et/ou à son transporteur. L’exécution du contrat de vente doit s’entendre d’un commun accord comme effectuée au siège du Vendeur.

2. OBJET DE LA FOURNITURE ET CONFIRMATION DE COMMANDE

L’objet de la fourniture se limite exclusivement aux prestations, aux marchandises et aux quantités indiquées dans la confirmation de commande ou dans toute autre communication écrite du Vendeur. Le contenu de la confirmation de commande prévaut dans tous les cas sur celui de l’éventuelle offre ou de la commande dans le cas où elles présenteraient des différences.

Une commande non confirmée par écrit ne peut en aucun cas être considérée comme acceptée, sauf en cas d’exécution de cette même commande par le Vendeur par communication écrite de « merchandise prête », d’expédition ou de livraison des produits. L’exécution partielle de la commande en l’absence de confirmation préalable n’a pas valeur d’approbation de l’intégralité de la commande mais d’approbation partielle pour la seule marchandise livrée. Dans ce cas, la remise de la marchandise au transporteur a valeur d’acceptation de la part de l’acheteur de la nouvelle proposition contractuelle.

3. LIVRAISON

La livraison s’entend effectuée auprès des établissements du Vendeur de Sassuolo. La marchandise est transportée aux risques et périls de l’acheteur quand bien même serait-elle expédiée en port payé. Sont également supportés par l’acheteur les risques potentiels de ruptures et/ou de manipulations ou de détérioration.

La livraison des produits s’effectue « Franco établissements Vendeur » ; cette condition et les éventuelles autres conditions de livraison convenues par écrit font référence aux « Incoterms » de la Chambre de Commerce International (dans l’édition en vigueur au moment de la vente). Dans le cas où le Vendeur et l’acheteur conviendraient par écrit que la livraison des produits doit s’effectuer « F.O.B. port italien », il est entendu que le choix du navire et du port italien d'embarquement est effectué par le VENDEUR qui agit pour le compte de l’acheteur. Les marchandises commandées par erreur ou commandées par erreur en quantité excessive par le client, ainsi que les marchandises restantes, ne sont pas retirées par le Vendeur. Les dimensions, les poids et les caractéristiques indiqués dans les tarifs doivent s’entendre comme indicatifs.

4. DÉLAIS DE LIVRAISON

Les délais établis pour la livraison de la marchandise doivent s’entendre comme étant en faveur des deux contractants. Les délais de livraison sont uniquement indicatifs et n’ont pas valeur d’engagement. Les éventuels retards occasionnés par quelque cause que ce soit ne donnent en aucun cas le droit à l’acheteur d’annuler des commandes ou d’exiger des dédommagements au titre de préjudices directs ou indirects. Le Vendeur se réserve expressément la faculté d’effectuer des livraisons partielles pour chaque commande. Dans le cas où des modifications auraient été apportées au contrat, le délai est prolongé d’une durée égale à celle initialement établie. En cas de retard de livraison, l’acheteur à la faculté, après mise en demeure, de refuser les livraisons effectuées ensuite et de résilier le contrat pour la part de produits non encore livrés. En cas de résiliation du contrat pour la part de produits non encore livrés, seul le paiement des produits effectivement livrés est exigible, toute forme de dédommagement ou d’indemnisation étant par ailleurs exclue.

5. CAS DE FORCE MAJEURE

Le Vendeur ne saurait être tenu pour responsable envers l’acheteur de tout manquement, défaut de livraison ou retard de livraison compris, occasionné par une cause indépendante de sa volonté, à savoir, à seul titre d'exemples, par un défaut de livraison ou un retard de livraison des matières/ matériels imputable aux fournisseurs, des pannes des installations/machines de production, des grèves et autres actions syndicales, la coupure de fournitures d’énergie, des arrêts ou des difficultés dans les transports.

Tout événement de force majeure a pour effet de suspendre, pendant toute sa durée, les délais de livraison. Dans le cas où, suite à un événement de force majeur, le contrat ne pourrait être honoré dans un délai de 60 jours à compter du terme convenu, chacune des parties a la faculté de résilier le contrat. Dans ce cas, la notification de résiliation doit être adressée à l’autre partie, par lettre recommandée avec accusé de réception, dans un délai de 10 jours à compter du terme des 60 jours smentionnés, aucune partie ne pouvant faire valoir un quelconque droit à un dédommagement ou à une indemnisation envers l’autre partie.

6. PRIX ET DÉLAIS DE PAIEMENT

Les prix des produits indiqués dans les catalogues en vigueur sont soumis aux conditions EXW (Franco Usine) ; aussi, toute charge ou frais relatif à l’expédition, à la livraison et/ou au transport des produits sont exclusivement à la charge de l’acheteur. Les prix s’entendent HT (la TVA devant être payée comme indiqué dans la facture). Le lieu de paiement est le siège du Vendeur à Sassuolo (MO), y compris en cas d’émission de traites, récépissés bancaire, de LCR (lettres de change relevés) ou en cas de délivrance d’effets de commerce : toute éventuelle dérogation de la disposition ci-dessus n’a de valeur qu’à condition d’avoir été accordée par écrit par le Vendeur.

Tout retard de paiement, y compris partiel, des factures du Vendeur, au-delà de l’échéance convenue, donne lieu, comme prévu par la loi, à l’application automatique des intérêts de retard, calculés comme indiqué dans le Décret législatif n°231/2002. En outre, tout défaut ou retard de paiement, y compris partiel, des factures - quelle qu’en soit la raison - donne droit au Vendeur, à sa seule appréciation, d’exiger le paiement anticipé des fournitures restantes. Tout défaut ou retard de paiement, y compris partiel, des sommes dues dans les délais convenus, toute procédure exécutoire, toute procédure de concours de créanciers ou de liquidation ainsi que toute variation de la situation financière de l’acheteur pouvant raisonnablement mettre en doute sa solvabilité, constitue une cause de résiliation, conformément à l’article 1456 du Code Civil, du contrat de fourniture et justifieent, conformément à l’article 1460 du Code civil, le refus de s’acquitter d’éventuelles autres obligations contractuelles et d’annuler la livraison d’éventuelles autres commandes en cours, sans que l’acheteur ne puisse faire valoir un quelconque droit à compensation, réparation ou autre.

Pour la facturation, sont valables les prix catalogue en vigueur le jour de la livraison. Dans le cas où une variation des prix interviendrait entre la confirmation de commande et le jour de la livraison, le Vendeur a le droit d’adapter les prix initialement convenus aux prix nouvellement en vigueur.

7. SOLVE ET REPETE

Sauf cas de nullité, annulabilité et de résiliation du contrat, l’acheteur ne peut faire valoir aucune exception dans le but de retarder ou d’éviter le paiement.

8. RÉSERVE DE PROPRIÉTÉ

Dans le cas où il serait prévu que le paiement, conformément à un accord stipulé dans le contrat, soit

effectué - en tout ou partie - après la livraison, les produits livrés restent la propriété du Vendeur tant que leur paiement intégral n’a pas été effectué.

La marchandise objet de réserve de propriété doit être, par l’acheteur, conservée matériellement à part et identifiée comme la propriété du Vendeur.

L’acheteur ne pourra vendre, en dehors de ses relations commerciales habituelles, remettre à des tiers, donner en gage ni disposer comme il l’entend des produits objet de réserve de propriété du Vendeur ; il devra en outre informer sans délai le Vendeur de tout droit que des tiers auraient acquis sur ces produits.

En cas de retard de paiement de l’acheteur, le Vendeur aura la faculté, sans formalité aucune, mise en demeure comprise, de retirer toute la marchandise objet de réserve de propriété, en conservant par ailleurs la faculté d’intenter toute action en justice au titre du préjudice subi.

9. GARANTIE

Les produits sont garantis conformes aux Normes UNI-DIN-EN actuellement en vigueur. La garantie appliquée se limite aux produits de premier choix. Aussi, toute garantie contre les vices est expressément exclue pour les produits de deuxième et troisième choix, les produits en stock et pour les lots occasionnels. Ces produits sont vendus après « vision et agrément ».

Les produits de premier choix sont garantis conformes aux Normes ISO en vigueur au moment de la vente avec une tolérance de 5% (cinq-pour-cent) ; quand bien même l’indication n’en serait pas expressément formulée, ils sont vendus en référence aux règles de l’art et aux pratiques d’usage dans le secteur céramique, ainsi qu’aux conseils d’utilisation figurant dans le catalogue général du Vendeur. Le respect des règles de pose DIN 18352 est une condition indispensable à la validité et à l’efficacité des garanties.

Les éventuelles réclamations ou contestations devront être adressées, à peine d’irrecevabilité par lettre recommandée, exclusivement au siège du Vendeur à Sassuolo (MO), avant la pose des produits, dans un délai de 8 jours à compter de leur réception et avant qu’ils ne soient revendus à des tiers. La pose des produits invalide toute action au titre de vices, aussi bien apparents que cachés, et a valeur implicite de renonciation à la garantie visée à l’article 1490 du Code civil.

Les illustrations et les descriptions figurant dans les catalogues, dans les tarifs et autres publications du Vendeur, ainsi que celles accompagnant les échantillons sont purement indicatives et n’ont aucunement valeur d’engagement. Les dimensions des produits objet de calibre, en particulier les sols en céramique dure émaillée et en grès cérame, doivent s’entendre comme sujettes aux tolérances d’usage. Les tons des produits doivent toujours s’entendre comme approximatifs et les éventuelles différences de teinte ne constituent pas un défaut du produit et ne sauraient comme telles justifier une réclamation.

Dans le cas où la réclamation serait fondée et présentée dans les délais prévus, l’obligation du Vendeur se limite à l’acceptation du retour de la marchandise et au remplacement de la marchandise défectueuse sur le lieu de la fourniture initiale, restant expressément exclus dans ce cas la résiliation du contrat de même que toute réduction du prix ou tout dédommagement.

La responsabilité et la garantie ne s’appliquent aucun cas aux produits déjà posés. Le remplacement des produits objet de réclamation ne sera pas effectué dans le cas où l’acheteur n’en n’aurait pas immédiatement suspendue l’utilisation au moment où le défaut a été constaté. Les éventuelles contestations relatives aux produits ne donnent pas le droit à l’acheteur de suspendre ni de différer, en tout ou partie, le paiement dont les délais ont été convenus, conformément à l’article 7 (voir plus haut).

10. CONTESTATIONS

Les contestations au titre de marchandise manquante doivent être adressées au moment de la réception. Les éventuelles contestations relatives à une marchandise livrée différente de celle convenue doivent elles aussi être notifiées au moment de la réception.

Les livraisons de marchandises expédiées doivent dans tous les cas être acceptées par l’acheteur. Les marchandises livrées et contestées et/ou les marchandises à retourner doivent être correctement entreposées par l’acheteur à l’abri de tout éventuel dommage.

La garantie au titre de vices cachés est exclue ou limitée dans les cas suivants : dépose non autorisée de l’ouvrage, pose non effectuée dans les règles de l’art, non-respect des prescriptions du Vendeur et des directives applicables aux dommages, adoption de mesures autres que celles usuellement prévues dans ce cas et qui auraient compromis la limitation des dommages. L’utilisation de marchandises défectueuses ou ne correspondant pas à celles commandées a valeur d’acceptation de caractéristiques qualitatives et exclut toute possibilité de contestation.

Pour faire valoir le droit à une indemnisation, il est obligatoire de démontrer que les produits ont été correctement traités et qu’ils ont été posés dans les règles de l’art.

Il est en outre obligatoire de garantir la possibilité de constater les défauts objet de contestation en l’état. Aussi, il est nécessaire d’accorder un délai suffisant pour pouvoir établir la cause du dommage.

Dans le cas où l’acheteur refuserait d’accorder ce délai, le Vendeur décline toute responsabilité. La partie lésée est tenue d’adopter toutes les mesures nécessaires afin de limiter au maximum l’ampleur des dommages. Elle doit en outre mettre à la disposition du Vendeur un nombre suffisant d’échantillons de la marchandise contestée.

Les réclamations inhérentes à des défauts constatés sur les pièces d’une fourniture n’ont pas pour effet d’invalider cette dernière mais se limitent aux seules pièces dont la défectuosité aura été constatée. Le Vendeur n’est pas tenu d’indemniser les dommages directs et indirects, de quelque nature que ce soit, subis par l’acheteur suite à l’utilisation ou à la non-utilisation des produits défectueux.

Aucune réclamation ou contestation ne donne le droit de suspendre ou de refuser le paiement des factures, paiement qui doit être effectué intégralement dans le respect des délais et conditions prévus.

11. INTERDICTION D’EXPORTATION

Sauf accords contraires, l’acheteur n’est en aucun cas autorisé à exporter les produits fournis par le Vendeur ni à les vendre à des entreprises ou à des personnes qui les destineraient à l’exportation.

12. MODIFICATIONS ET COMPLÈMENTS

Les contrats de vente réglés par les présentes conditions générales peuvent être modifiés uniquement par un document ou une communication écrite, signés par les représentants légaux des parties.

13. LOI APPLICABLE ET TRIBUNAL COMPÉTENT

Les présentes conditions de vente et chaque contrat stipulé entre le Vendeur et l’acheteur, y compris les contrats de vente à l’exportation, sont réglés par la loi italienne.

En cas de litige inhérent à la vente de produits par le Vendeur et aux rapports liés à ces ventes, le seul tribunal compétent est le Tribunal de Modène.

14. EFFECTIVITÉ DE CHAQUE CONDITION

Les conditions générales de vente susmentionnées ne doivent en aucun cas s’entendre comme de simples clauses de style. Elles sont effectives et sont l’expression fidèle de la volonté commerciale des parties, étant le fruit d’une négociation menée dans les moindres détails.

15. ANNULATION D’UNE COMMANDE

Pour annuler une commande de matériaux déjà livrés à notre dépôt, et pour une restitution autorisée, une somme équivalente à 15 % de la valeur imposable vous sera débitée, avec un montant fixe minimum de 20€, en tant que participation aux frais de transport et de resélection.

16. COMMANDES MINIMALES

Pour toutes les cdes inférieures à 10 boîtes (cde isolée ou complément de cde) il y aura un supplément fixe, de 20€ de prévu.

Allgemeine Geschäfts- und Garantiebedingungen

Allgemeine Geschäfts- und Garantiebedingungen

Allgemeine Geschäfts- und Garantiebedingungen

1. VERTRÄGLICHE REGELUNG

Diese vertraglichen Regelungen bilden einen wesentlichen Teil aller Kaufverträge, an denen die Sichenia Gruppo Ceramiche S.p.A. beteiligt ist.

Vorbehaltlich von Einzelfällen, bei denen mit ausdrücklichen schriftlichen Vereinbarungen abgewichen wird, die von Sichenia Gruppo Ceramiche S.p.A. (im Weiteren Verkäufer) unterzeichnet werden, bilden sie die ausschließliche Regelung für diese Verkäufe. Sollten ein oder mehrere Teile dieser Bedingungen oder der einzelnen Verträge, die sie enthalten, ungültig sein, bleiben die allgemeinen oder besonderen Bedingungen in ihrer Gesamtheit gültig; die ungültigen Teile werden durch Vereinbarungen ersetzt, die dem ursprünglichen Willen der Parteien möglichst nahe kommen. Jedes Angebot, jede Auftragsbestätigung und jede Lieferung seitens des Verkäufers versteht sich vorbehaltlich einer von diesem Verkäufer unterzeichneten ausdrücklichen schriftlichen Abweichung als zu diesen Bedingungen erfolgt; die Annahme dieser Angebote und die Abnahme der vom Verkäufer kommenden Produkt zieht deshalb die Annahme dieser Bedingungen nach sich, die durch die eventuellen schriftlichen Vereinbarungen zwischen den Parteien ergänzt werden. Der Verkauf versteht sich als zu dem Zeitpunkt abgeschlossen, zu dem der Geschäftsherr oder der Auftraggeber persönlich Kenntnis von der Zustimmung der Gegenpartei erhalten; sollte diese Zustimmung nicht schriftlich zum Ausdruck gebracht worden sein, können als schriftliche Mitteilung der Zustimmung ausschließlich die schriftlichen Mitteilungen über das Bereitstehen der Ware oder bei deren Nichtvorhandensein die Lieferung der Ware an den Auftraggeber oder schließlich, bei deren Fehlen, die erfolgte erste Lieferung der Produkte an den Auftraggeber und/oder an seinen Spediteur gelten. Für die Ausführung des Kaufvertrags wird in jedem Fall konventionell festgelegt, dass sie am Sitz des Verkäufers erfolgt.

2. GEGENSTAND DER LIEFERUNG UND AUFTRAGSBESTÄTIGUNG

Die Lieferung umfasst nur die in unserer Auftragsbestätigung oder in anderen von uns kommenden schriftlichen Mitteilungen angegebenen Leistungen, Materialien und Mengen. Der Wortlaut unserer Auftragsbestätigung hat in jedem Falle Vorrang gegenüber dem abweichenden Wortlaut des eventuellen Angebots oder der Bestellung. Der nicht schriftlich bestätigte Auftrag kann keinesfalls als akzeptiert gelten, es sei denn er wird von uns mittels schriftlicher Mitteilung über das Bereitstehen der Ware, Versand oder Auslieferung der Produkte ausgeführt. Die teilweise Ausführung des Auftrags ohne vorherige Bestätigung bedeutet keine Bestätigung unsererseits für den gesamten Auftrag, sondern eine Teilbestätigung bezüglich der übergebenen Ware. In diesem Fall kommt die Übergabe der Ware an den Spediteur der Annahme des neuen Vertragsangebots durch den Käufer gleich.

3. LIEFERUNGEN

Die Lieferung versteht sich bei unserem Betriebsteil von Sassuolo ausgeführt. Die Ware reist immer auf Risiko und Gefahr des Käufers, auch wenn sie mit Transportkosten zu Lasten des Absenders verkauft wird. Somit gehen zu Lasten des Käufers auch die Risiken für eventuelle Defekte und/oder Manipulationen oder Schäden. Die Lieferung der Produkte erfolgt nach der Formel «Frei Werk des Verkäufers»; diese Formel, wie auch die Formen für die Rückgabe, die ggf. schriftlich alternativ zu dieser vereinbart werden, beziehen sich auf die «Incoterms» der Internationalen Handelskammer, die zum Zeitpunkt des Verkaufs Gültigkeit haben. Sollten Verkäufer und Käufer schriftlich vereinbaren, dass die Rückgabe der Produkte «F.O.B. italienischer Hafen» erfolgt, versteht sich darunter, dass die Wahl des Schiffes und des italienischen Abfahrthafens dem VERKÄUFER obliegt, der im Auftrag des Käufers handelt. Vom Auftraggeber aufgrund eines Fehlers, zu viel bzw. zu wenig bestellte Waren werden von unserer Gesellschaft nicht zurückgenommen. Abmessungen, Gewichte und Eigenschaften, die in unseren Preislisten angegeben sind, sind als Richtwerte zu verstehen.

4. LIEFERFRISTEN

Die für die Lieferung der Ware vereinbarte Frist ist zu Gunsten beider Vertragspartner zu verstehen. Die Lieferfristen sind reine Richtwerte und nicht endgültig. Eventuelle Verspätung aufgrund beliebiger Ursachen geben dem Käufer niemals das Recht, Aufträge zu annullieren oder den Ersatz eventueller direkter oder indirekter Schäden zu fordern. Der Verkäufer behält sich ausdrücklich vor, Teillieferungen bezüglich jedes Auftrags vorzunehmen. Würden Änderungen am Vertrag vorgenommen, verlängert sich die Lieferzeit um den gleichen Zeitraum, wie den anfänglich festgelegten. Bei einer Verspätung bei den Lieferungen kann der Käufer nach einer üblichen Inverzugsetzung, weitere Lieferungen ablehnen und den Vertrag für den Teil der noch nicht gelieferten Produkte kündigen. Die Kündigung des Vertrags für den noch nicht gelieferten Teil aufgrund von Verspätung hat nur die Bezahlung der effektiv gelieferten Produkte ausschließlich jedes/r weiteren Ersatzes und Entschädigung zur Folge.

5. HÖHERE GEWALT

Der Verkäufer ist gegenüber dem Käufer nicht für jede Nichterfüllung einschließlich der mangelnden oder verspäteten Lieferung verantwortlich, die durch Ereignisse verursacht werden sie sich seiner angemessenen Kontrolle entziehen, wie rein Beispielsweise, die mangelnde oder verspätete Lieferung der Materialien zur Verarbeitung seitens der Zulieferer, Schäden an den Anlagen, Streiks und andere Arbeitsk Kampfmaßnahmen, Unterbrechung der Energieversorgung, Unterbrechungen oder Schwierigkeiten bei den Transporten. Jedes Ereignis höherer Gewalt unterbricht den Ablauf der Lieferfrist für ihre gesamte Dauer. Sollte der Vertrag in Folge von Ereignissen höherer Gewalt nicht innerhalb von 60 Tagen nach der vereinbarten Frist ausgeführt werden, kann jede der beiden Parteien vom Vertrag zurücktreten. In diesem Fall muss die Rücktrittserklärung der anderen Partei mittels Einschreiben mit Rückschein innerhalb der 10 Tage nach dem Ablauf der vorgenannten 60 Tage zugesandt werden, wobei die gegenseitigen Rechte auf Entschädigungen oder Schadensersatz ausgeschlossen bleiben.

6. PREISE UND ZAHLUNGSBEDINGUNGEN

Die in den geltenden Katalogen angegebenen Preise der Produkte sind EXW (frei Werk); daraus folgt, dass jegliche weitere Kosten bezüglich Versand, Lieferung und/oder Transport der Produkte ausschließlich zu Lasten des Käufers gehen. Die Preise verstehen sich zuzüglich Mehrwertsteuer, die gemäß den Angaben in der Rechnung zu zahlen ist. Der Ort der Zahlung ist an unserem Verwaltungssitz in Sassuolo (MO) festgelegt, auch im Falle der Ausstellung von Tratten, Bankakzepten, Wechseln bzw. der Ausstellung von Eigenwechseln: eine eventuelle Abweichung zu Vorstehenden ist nur gültig, wenn sie von uns in schriftlicher Form genehmigt wird.

Die auch nur teilweise Verspätung der Bezahlung unserer Rechnungen über die vereinbarte Frist hinaus, hat, wie gesetzlich vorgesehen, den automatischen Beginn von Verzugszinsen zur Folge, die entsprechend den Regelung im gesetzestretretenden Dekret Nr. 231 des Jahres 2002 berechnet werden. Außer der nicht erfolgreichen oder verspäteten Bezahlung gibt auch die teilweise Bezahlung der Rechnungen – aus beliebigem Grund - dem Verkäufer das Recht, das von keiner anderen Maßnahmen beeinträchtigt wird, die Vorauszahlung der anderen Lieferungen zu fordern. Die mangelnde oder verspätete Bezahlung, auch teilweise Art, des in den Bedingungen vereinbarten Preises oder der Vergütung, das Unterliegen des Käufers bei Vollstreckungs-, Konkurs- oder Liquidationsverfahren, die veränderten Vermögenssituationen des Käufers, die berechtigterweise auf einen Krisenzustand schließen lassen, sind Grund für eine Kündigung des Kaufvertrages laut Art. 1456 ital. ZGB und rechtfertigen in jedem Falle laut Art. 1460 des ital. ZGB die Weigerung, eventuellen weiteren vertraglichen Verpflichtungen nachzukommen und die Bearbeitung eventuelle weiterer laufender Aufträge zu annullieren, ohne dass der Käufer Forderungen für Vergütungen, Entschädigungen oder anderes stellen kann. Für die Rechnungslegung gelten die am Tag der Lieferung geltenden Preislisten. Bei einer Veränderung der Preise zwischen der Auftragsbestätigung und dem Tag der Lieferung hat der Verkäufer das Recht, die vereinbarten Preise der neuen Situation anzupassen.

7. SOLVE ET REPETE

Kein Einwand, außer der Nichtigkeit oder Nichtigerklärung und Auflösung des Vertrages kann gegenüber den Käufer entgegengehalten werden, um die Bezahlung zu verspäten oder zu vermeiden.

8. EIGENTUMSVORBEHALT

Sollte die Bezahlung aufgrund vertraglicher Vereinbarungen - vollständig oder teilweise - nach der

Lieferung ausgeführt werden, bleiben die gelieferten Produkte bis zur vollständigen Bezahlung des Preises Eigentum des Verkäufers.

Die den Gegenstand des Eigentumsvorbehalts bildende Ware muss durch den Käufer separat aufbewahrt und als Eigentum des Verkäufers gekennzeichnet werden. Der Käufer kann außerhalb seiner normalen Geschäftsbeziehungen die Produkte, die Gegenstand des Eigentumsvorbehalts des Verkäufers sind, weder verkaufen, an Dritte übergeben, als Pfand überlassen noch über sie verfügen; außerdem muss er den Verkäufer umgehend von allen Rechten informieren, die Dritte an dieser Ware erworben haben können.

Bei Verzug des Käufers kann der Verkäufer, ohne Notwendigkeit von Formalitäten, einschließlich der Inverzugsetzung, die gesamte Ware, die Gegenstand des Eigentumsvorbehalts ist, unter Vorbehalt jeder weiteren angebrachten Maßnahme für den erlittenen Nachteil abholen.

9. GARANTIE

Unsere Materialien werden gemäß den derzeit geltenden Bestimmungen UNI-DIN-EN garantiert. Unsere Garantie ist auf die Materialien erster Wahl beschränkt. Jegliche Garantie für Mängel ist somit für Materialien zweiter und dritter Wahl oder Sonderpartien ausdrücklich ausgeschlossen. Diese Materialien werden wie «gesehen und gefallen» verkauft.

Die Materialien 1. Wahl werden gemäß den zum Zeitpunkt des Verkaufs geltenden Bestimmungen ISO mit einer Toleranz von 5% (fünf Prozent) garantiert; alles, was nicht ausdrücklich festgelegt ist, wird mit Bezug auf die Regeln der Technik und die allgemeinen gebräuchlichen Vorgehensweisen, die im Bereich der Keramik verwendet werden, und den in unserem Hauptkatalog aufgeführten Verwendungsweisen verkauft.

Unerlässliche Bedingung für die Gültigkeit und Wirksamkeit der Garantien ist die Einhaltung der Verlegebestimmungen der DIN 18352.

Eventuelle Reklamationen und Beanstandungen müssen mittels Einschreiben allein bei unserem Verwaltungssitz in Sassuolo (MO), vor der Verlegung des Materials und innerhalb einer unumgänglichen Frist von 8 Tagen nach dem Erhalt des Materials sowie in jedem Falle vor seinem nachfolgenden Weiterverkauf an Dritte vorgebracht werden, anderenfalls wird dieses Recht verwirkt. Die Verlegung des Materials hat die Verwirkung der Mängelanzeige sowohl offensichtlicher als auch verdeckter Art zur Folge, wozu ein implizierter Verzicht auf die Garantie laut Art. 1490 ital. ZGB nötig ist.

Die Abbildungen und die Beschreibungen der Kataloge und der Preislisten, aller unserer Veröffentlichungen und Mustersammlungen sind nicht verbindlich sondern reine Richtwerte. Die Abmessungen der einem Kaliber unterliegenden Produkte, wie im Besonderen die Bodenbeläge aus glasiertem Hartporzellan und Feinsteinzeug, verstehen sich mit den gewöhnlichen Toleranzen. Die Farböne der Materialien verstehen sich immer annähernd und die eventuellen Unterschiede im Farbton bilden keinen Defekt des Materials und können nicht als solche angezeigt werden.

Erfolgt die Reklamation umgehend und ist sie begründet, ist die Pflicht des Verkäufers auf die Rückgabe und den nachfolgenden Ersatz der mangelhaften oder defekten Ware am gleichen Ort der Erstlieferung beschränkt, wobei somit unbedingt auf die Auflösung des Vertrages verzichtet und diese ausgeschlossen wird, wie auch jegliche Preisreduzierung oder jeglicher Schadensersatz. Die Haftung und die Garantie erstrecken sich in keiner Weise auf die bereits verlegten Materialien.

Der Ersatz des von der Beanstandung betroffenen Materials erfolgt nicht, wenn der Käufer nicht sofort den Einbau zum Zeitpunkt der Feststellung eingestellt hat.

Eventuelle Beanstandungen am Material geben dem Käufer nicht das Recht, die Zahlung innerhalb der laut dem vorstehenden Art. 7 vereinbarten Fristen einzustellen oder zu verspäten.

10. BEANSTANDUNGEN

Die Beanstandungen für die fehlende Ware müssen zum Zeitpunkt des Erhalts erhoben werden. Außerdem sind zum Zeitpunkt des Erhalts eventuelle Beanstandungen für abweichend zu den Vereinbarungen gelieferte Ware mitzuteilen.

Lieferungen von versandter Ware müssen in jedem Fall vom Auftraggeber angenommen werden. Lieferungen, die beanstandetes und/oder zurück zu gebendes Material enthalten, müssen vom Käufer angemessen und vor eventuellen Schäden geschützt eingelagert werden.

Die Garantie für verdeckte Mängel bleibt ausgeschlossen oder begrenzt, bei: unbefugte Entfernung der Verlegung, nicht fachgerecht vorgenommene Verlegung, Nichtbeachtung unserer Vorschriften und besonderen Richtlinien zur Anwendung; Beschädigungen, die nicht der normalen Sorgfalt entsprechen und die Begrenzung der Schäden beeinträchtigt haben. Die Verwendung von offensichtlich defekter oder von der Bestellung abweichender Ware impliziert die Annahme der Qualitätseigenschaften und schließt jegliche Beanstandung aus.

Für jede Entschädigung ist der Nachweis, dass die Ware angemessen behandelt und fachgerecht verlegt wurde, obligatorisch. In jedem Fall ist es unabdingbar, dass uns die Möglichkeit gegeben wird, die beanstandeten Defekte in ihrem Originalzustand zu kontrollieren. In diesem Fall muss eine ausreichende Frist für die Feststellung der Ursache des Schadens gewährt werden. Sollte dieses Recht vom Käufer verweigert werden, lehnen wir jede Haftung für die Entschädigung ab. Der Geschädigte hat die Pflicht, alle erforderlichen Maßnahmen einzuleiten, um die Schäden auf das Minimum zu begrenzen. Außerdem muss er eine ausreichende Anzahl von Mustern der beanstandeten Ware absichern.

Die Reklamationen, die die in den Teilen einer Lieferung festgestellten Defekte widerspiegeln, beeinträchtigen nicht deren Gültigkeit, sondern bleiben auf die defekten Teile beschränkt. Der Verkäufer ist nicht verpflichtet, direkte und indirekte Schäden jeglicher Art zu ersetzen, die dem Käufer durch den Einsatz oder den mangelnden Einsatz des defekten Materials entstanden sind. Jegliche Reklamation oder Beanstandung impliziert nicht die Einstellung oder Verweigerung der Bezahlung der Rechnungen, die Bezahlung muss ordnungsgemäß und vollständig innerhalb der vereinbarten Fristen erfolgen.

11. AUSFUHRBOT

Vorbehaltlich gegenseitlicher Vereinbarungen ist es dem Käufer verboten, unsere ihm gelieferten Materialien zu exportieren oder an Firmen oder Personen zu veräußern, die sie exportieren.

12. ÄNDERUNGEN UND ERGÄNZUNGEN

Die von diesen allgemeinen Bedingungen geregelten Kaufverträge dürfen nur mittels eines Dokuments oder einer schriftlichen Mitteilung geändert werden, die von den gesetzlichen Vertretern der Parteien unterzeichnet sind.

13. ANWENDBARES GESETZ UND RICHTSSTAND

Diese Geschäftsbedingungen und jeder zwischen dem Verkäufer und dem Käufer abgeschlossene Vertrag, einschließlich der Kaufverträge zum Export, werden durch das italienische Gesetz geregelt. Zuständiger Gerichtsstand für alle Streitsachen bezüglich des Verkaufs von Produkten durch den Verkäufer und die mit diesen Verkäufen verbundenen Beziehungen ist ausschließlich der von Modena.

14. WIRKSAMKEIT JEDER BEDINGUNG

Die oben aufgeführten allgemeinen Geschäftsbedingungen dürfen nicht ausschließlich als reine Stilkausenl verstanden werden. Sie sind wirksam und verkörpern getreu den Verhandlungswillen der Parteien sowie das Ergebnis einer aufmerksamen und spezifischen Verhandlung.

15. STORNIERUNG VON BESTELLUNGEN

Für die Genehmigung Stornierung von Bestellungen von bereits an unser Lager gelieferten Materialien, und für autorisierte Rückgaben, werden 15% des Steuerwertes bzw. mindestens 20€ als Kostenbeitrag für den Transport und die erneute Auswahl in Rechnung gestellt.







16. MINDESTBESTELLMENGE

Für Nach- oder Einzelbestellungen die kleiner als 10 Pakete sind , wird ein pauschaler Aufpreis von 20€ für die Bearbeitung erhoben.







^[1] Diese vertraglichen Regelungen bilden einen wesentlichen Teil aller Kaufverträge, an denen die Sichenia Gruppo Ceramiche S

^[2] Diese vertraglichen Regelungen bilden einen wesentlichen Teil aller Kaufverträge, an denen die Sichenia Gruppo Ceramiche S

Packing list

FORMATI . Sizes . Formats . Formate	Pz x 	m² x 	kg x 	 x 	m² x 	kg x 	
7,2x7,2 2,8"x2,8"	9 mm	132	0,684	13,150	48	32,845	631
7,2 x30 2,8"x12"	9 mm	33	0,712	13,700	48	34,176	678
8x41 3"x16"	9 mm	22	0,721	17,070	60	43,296	1044
9,7x53 4"x21"	Chevron Dx - Sx 9 mm	16	0,822	20,000	40	32,880	820
11x45 4,5"x18"	10 mm	24	1,188	26,000	39	46,332	1034
10x60 4"x24"	Muretto 10 mm	30	1,800	33,100	30	54,000	1013
16,5x41 6,5"x16"	10 mm	16	1,082	22,060	48	51,936	1079
20x60 8"x24"	10 mm	8	0,960	19,200	48	46,080	942
22,5x22,5 9"x9"	10 mm	24	1,210	26,400	26	31,460	706
	14 mm	18	0,911	27,700	26	23,691	740
22,5x45 9"x18"	10 mm Dolmen	12	1,215	24,530	39	47,385	977
	10 mm	13	1,315	27,400	39	51,285	1089
	14 mm	9	0,911	27,500	39	35,529	1092
30x30 12"x12"	9 mm	13	1,170	22,640	40	46,800	926
	Mod. rete quadrato 9 mm	4	0,360	7,100	80	28,800	592
30x60 12"x24"	9 mm	6	1,080	20,510	48	51,840	1004
30x90 12"x24"	Muretto 10 mm	4	1,080	22,400	48	51,840	1095
	9 mm	4	1,440	27,660	30	43,200	850
60x60 24"x24"	14 mm	3	1,080	34,100	30	32,400	1043
	20 mm	2	0,720	31,670	30	21,600	970
60x90 24"x36"	9 mm	3	1,620	30,690	32	51,840	1002
	20 mm	1	0,540	23,890	45	24,300	1095
90x90 36"x36"	9 mm	2	1,620	31,760	25	40,500	812
	20 mm	1	0,810	35,500	25	20,250	907
20x120 8"x48"	9 mm	6	1,440	27,360	36	51,840	1004
	Fascia Modulo rete	4	0,960	19,400	36	34,560	718
30x120 12"x48"	9 mm	4	1,440	28,600	36	51,840	1050
40x120 16"x48"	20 mm	1	0,480	21,040	48	23,040	1030
60x120 24"x48"	9 mm	2	1,440	28,010	35	50,400	1000
	20 mm	1	0,720	31,950	35	25,200	1138
120x120 48"x48"	9mm	2	2,880	52,800	16	46,080	865

Packing list PEZZI SPECIALI . SPECIAL PIECES . PIÈCES SPÉCIALES . SPEZIALTEILE

FORMATI . Sizes . Formats . Formate	Pz x 	m² x 	kg x 	 x 	m² x 	kg x 	
6x60 2"x24"	Battiscopa	15	0,540	11,400	48	25,920	568
6x120 2"x48"	Battiscopa	7	0,540	11,800	50	25,200	613
7x41 2,5"x16"	Battiscopa	12	0,344	7,500	65	22,386	508
7x60 2,5"x24"	Battiscopa	15	0,504	13,800	48	24,192	682
7x90 2,5"x36"	Battiscopa	9	0,503	10,800	78	39,311	862
8x41 3"x16"	Bullnose	12	0,393	8,400	65	25,584	566
15x30 6"x12"	Elemento a "L"	8	0,360	9,000	-	-	-
30x60 12"x24"	Gradino Becco di Civetta	6	1,080	33,360	-	-	-
33x60 13"x24"	Gradino costa retta	4	0,792	18,500	-	-	-
33x33 13"x13"	Angolo gradino costa retta	4	0,435	9,600	-	-	-
33x120 13"x48"	Gradino costa retta	2	0,792	19,600	-	-	-
33x120 13"x48"	Angolo gradino costa retta SX / DX	1	0,396	10,600	-	-	-
17x45 7"x18"	Gradino costa retta 14 mm	4	0,306	12,400	-	-	-
17x45 9"x18"	Angolo Int. costa retta 14 mm	2	0,248	10,000	-	-	-
17x17 7"x7"	Angolo Est. costa retta 14 mm	2	0,057	2,300	-	-	-
33x60 13"x24"	Gradino Costa Retta 20 mm	2	0,540	25,800	-	-	-
33x60 13"x24"	Ang. Int. Grad. Costa Retta 20 mm	1	0,450	21,400	-	-	-
33x90 13"x36"	Gradino costa retta 20 mm	1	0,270	12,900	-	-	-
33x90 13"x36"	Gradino costa retta angolo interno 20 mm	1	0,450	21,400	-	-	-
33x33 13"x13"	Ang. Est. Grad. Costa Retta 20 mm	2	0,217	11,300	-	-	-
30x90 12"x36"	Gradino toro 20 mm	1	0,270	11,800	-	-	-
30x90 12"x36"	Angolo gradino toro interno / esterno SX / DX 20 mm	1	0,450	19,700	-	-	-
30x90 12"x36"	Gradino costa lucida 20 mm	1	0,270	11,800	-	-	-
30x90 12"x36"	Angolo gradino costa lucida interno / esterno SX / DX 20 mm	1	0,450	19,700	-	-	-
33x120 13"x48"	Gradino Costa Retta 20 mm	1	0,480	22,300	-	-	-
33x120 13"x48"	Angolo Int. Gradino Costa Retta 20 mm	1	0,800	36,800	-	-	-
33x33 13"x13"	Angolo Est. Gradino Costa Retta 20 mm	2	0,217	11,300	-	-	-
40x120 16"x48"	Gradino toro 20 mm	1	0,480	20,000	-	-	-
40x120 16"x48"	Angolo gradino toro interno/esterno SX / DX 20 mm	1	0,800	33,400	-	-	-
40x120 16"x48"	Gradino costa lucida 20 mm	1	0,480	20,000	-	-	-
40x120 16"x48"	Angolo gradino costa lucida interno/esterno SX / DX 20 mm	1	0,800	33,400	-	-	-



PAVIMENTI PER INTERNO
Indoor floor tiles . Carrelages d'intérieur . Bodenbeläge für den Innenbereich.



RIVESTIMENTI PER INTERNO
Indoor wall tiles . Revêtements d'intérieur . Wandbeläge für den Innenbereich.



PAVIMENTI PER ESTERNO
Outdoor floor tiles . Carrelages d'extérieur . Bodenbeläge für den Außenbereich.



RIVESTIMENTI PER ESTERNO
Outdoor wall tiles . Revêtements d'extérieur . Wandbeläge für den Außenbereich.



CONTINUITÀ DI SUPERFICIE TRA INTERNI ED ESTERNI . Seamless transitions from indoors to out.
Continuité de surface entre l'intérieur et l'extérieur . Farbliche Kontinuität zwischen Innen und Aussen.



CLASSIFICAZIONE DELLE TONALITÀ
Color Shade Variation Guide . Classification des tonalités . Farbspiel-Klassifizierung.



COEFFICIENTE DI ATTRITO. SCIVOLOSITÀ
Friction coefficient . Slipperiness . Coefficient de frottement . Glissance . Reibungskoeffizient . Rutschgefahr.



SPESSORE
Thickness . Épaisseur . Dicke.

PM - 49,00

PREZZO AL METRO QUADRO
Price per square meter . Prix au mètre carré . Preis pro qm

PP - 49,00

PREZZO AL PEZZO
Price per piece . Prix à la pièce . Preis pro Stück

PL - 49,00

PREZZO AL METRO LINEARE
Price per linear meter . Prix au mètre linéaire . Preis pro lfdm

SICHENIA
ECCELLENZA CERAMICA ITALIANA

Sichenia Gruppo Ceramiche S.p.A. Via Toscana, 12 - 41049 Sassuolo (Modena) - Italy
Tel. +39 0536.81.84.11 - Fax Italia +39 0536.81.01.05 / export +39 0536.80.08.15
info@sichenia.it - www.sichenia.it

La riproduzione, la pubblicazione, e la distribuzione, totale o parziale, di tutto il materiale originale contenuto in questo documento sono espressamente vietate in assenza di autorizzazione da parte di Sichenia.

Sichenia si riserva di modificare i prodotti senza preavviso, declinando ogni responsabilità su eventuali danni diretti o indiretti derivanti da eventuali modifiche.

I colori e le caratteristiche estetiche dei materiali illustrati nel presente catalogo sono da ritenersi puramente indicativi.

Per le informazioni e i dati relativi ai codici, imballaggi e pesi occorre sempre consultare l'ultimo listino aggiornato e in vigore.

The reproduction, publication, and distribution, total or partial, of all the original material contained herein is expressly prohibited without the prior consent of Sichenia.

Sichenia reserves the right to make changes to the products without notice, and shall not be liable for any direct or indirect damages arising from any changes.

The colours and the aesthetic characteristics of the products shown in this catalogue are purely illustrative.

For information and data concerning codes, packaging and weight always refer to the last updated price list in force.

La riproduzione, la pubblicazione e la distribuzione, totales ou partielles, de tout le matériel original contenu dans ce document sont expressément interdites sans l'autorisation de Sichenia.

Sichenia se réserve la faculté de modifier les produits sans préavis, en déclinant toute responsabilité relative à des dommages directs ou indirects dérivant d'éventuelles modifications.

Les couleurs et les caractéristiques esthétiques du matériel illustré dans ce catalogue sont fournis à titre purement indicatif.

Pour les informations et les données relatives aux codes, aux emballages et aux poids, il est toujours nécessaire de consulter le dernier tarif mis à jour et en vigueur.

Die vollständige oder auszugsweise Vervielfältigung, Veröffentlichung und Verbreitung des gesamten, in diesem Dokument enthaltenen Originalmaterials, ist ohne Genehmigung der Firma Sichenia ausdrücklich untersagt.

Sichenia behält sich das Recht vor, die Produkte ohne vorherige Ankündigung zu ändern und haftet nicht für direkte oder indirekte, durch eventuelle Änderungen verursachte Schäden.

Die Farben und ästhetischen Merkmale des im vorliegenden Katalogs abgebildeten Materials sind rein zur Information und nicht bindend.

Für Informationen zu den Daten der Codenummern, Verpackungen und Gewichten siehe immer die neuste, jeweils gültige Preisliste.

MADE IN ITALY

