

OUTDOOR 20MM



OUTDOOR20MM

INDEX . SOMMAIRE . INHALTSVERZEICHNIS

INTRO	04
Ispirazioni	16
Color palette	
Palette de couleurs	
Die farbpalette	
Collezioni	
Collection	
Collections	
Kollektionen	
STONEPIETRE	
ARDENNES	70
MY STONE	72
CHANTILLY	74
CREMA LUNA	76
PAVÉ DELLE ALPI	78
AMBOISE	82
AR_GENT	84
CHATEAUX	86
MARBLEMARMI	
NAVONA	88
CONTEMPORARYCONTEMPORANEO	
CON_CRETE	90
BLOCK	92
WOODLEGNI	
P_ARKETT	94
SILVIS	98
INFO TECNICHE	100

SICHENIA 20MM

Le lastre con spessore 20MM nascono per risolvere le problematiche di arredo degli spazi esterni, consentendo soluzioni sicure per le zone residenziali e pubbliche. Le elevate caratteristiche tecniche del prodotto, la notevole qualità estetica e la facilità di posa (su massetto, a secco, sopraelevata o su erba) rendono il gres porcellanato Sichenia spessore 20MM ideale per le soluzioni esterne.

The 20MM thick slabs are designed to solve exterior design problems, offering safe solutions for residential and public areas. The high technical characteristics of the product, its remarkable aesthetic quality and the easy laying solution (on screed, gravel, elevated or on grass) make the Sichenia porcelain stoneware 20MM thickness ideal for outdoor solutions.

Les dalles d'une épaisseur de 20MM sont spécialement conçues pour résoudre les problèmes de la décoration des espaces extérieurs, ce qui permet solutions sûres pour zones résidentielles et publiques. Les élevées caractéristiques techniques du produit, la remarquable qualité esthétique et la facilité de pose (sur chape, à sec, surélevées, ou sur l'herbe) rendent Sichenia grès céramé 20MM d'épaisseur, idéal pour les solutions externes.

Die 20MM dicken Platten wurden entwickelt, um den Anforderungen der Gestaltung von Außenräumen zu erfüllen und sichere Lösungen für Wohn- und öffentliche Bereiche zu ermöglichen. Die hohen technischen Eigenschaften des Produkts, die bemerkenswerte ästhetische Qualität und die einfache Installation (auf Estrich, im Splittbett, aufgestellt oder Gras) machen Sichenia-Feinsteinzeug mit einer Dicke von 20MM ideal für Außenlösungen.

Collection ARDENNES
Pavimento . Floor:
 Cream 90x90 . 36"x36" Ret - GRIP 20mm
 Cream 60x120 . 24"x48" Ret - GRIP 20mm

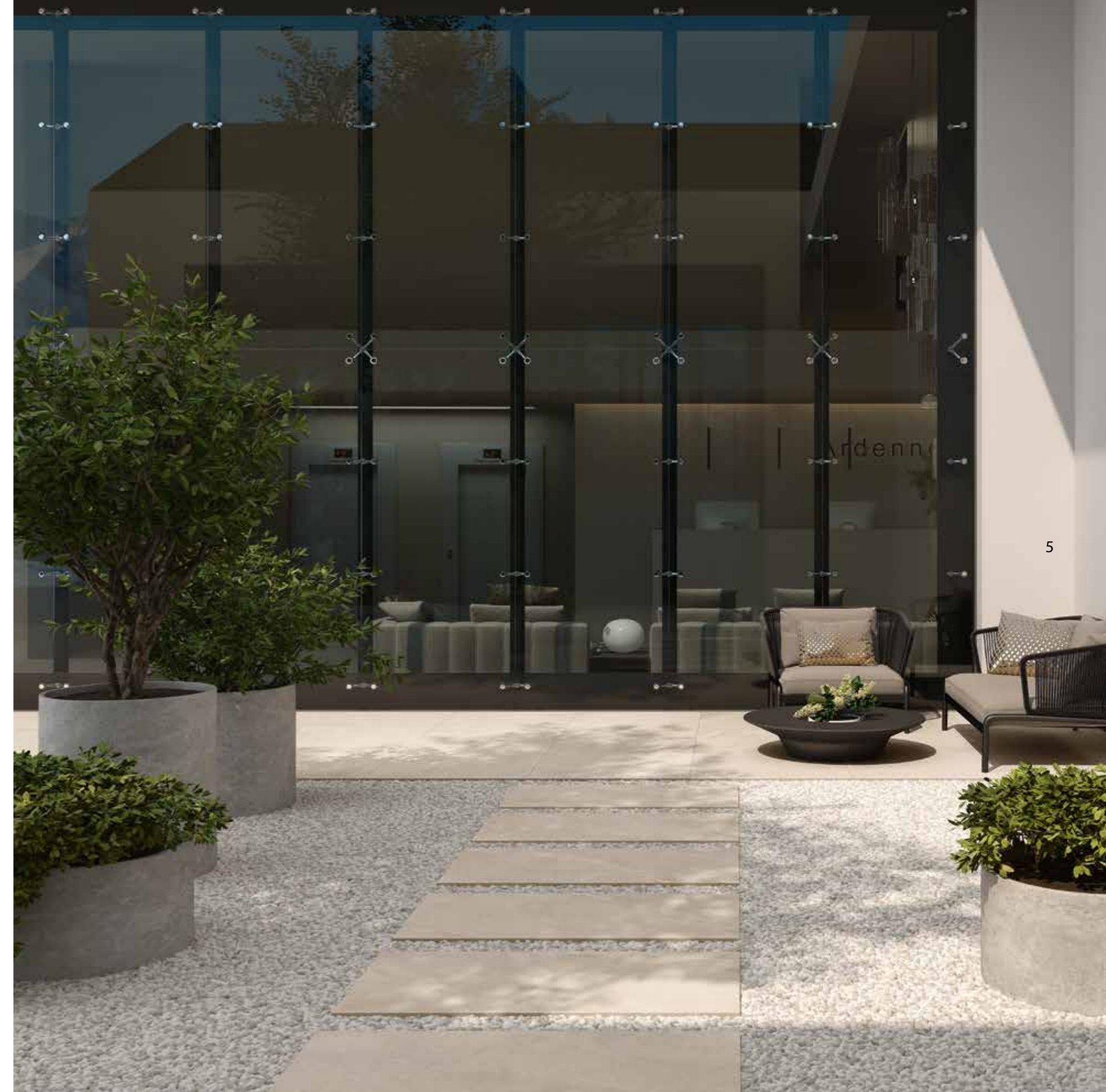



MADE IN ITALY

L'eccellenza italiana in ogni superficie.

Per Sichenia, il Made in Italy è una filosofia produttiva basata su creatività, competenza e passione. Ogni collezione nasce da materie prime selezionate, design raffinato e rispetto per l'ambiente e le persone. È l'espressione autentica di un saper fare che unisce tradizione e innovazione.

Italian excellence in every surface.

For Sichenia, Made in Italy is more than a label, it's a way of working, rooted in creativity, expertise, and passion. Each collection is crafted from carefully selected materials, refined design, and a commitment to people and the environment. It reflects the authentic Italian know-how, where tradition meets innovation.

L'excellence italienne à chaque surface.

Pour Sichenia, le Made in Italy n'est pas qu'un label : c'est une philosophie de production fondée sur la créativité, le savoir-faire et la passion. Chaque collection est issue de matières premières soigneusement sélectionnées, d'un design raffiné et d'un engagement envers l'environnement et les personnes. C'est l'expression authentique d'un art italien qui allie tradition et innovation.

Italienische Exzellenz auf jeder Oberfläche.

Für Sichenia ist Made in Italy mehr als ein Label – es ist eine Produktionsphilosophie, die auf Kreativität, Kompetenz und Leidenschaft basiert. Jede Kollektion entsteht aus sorgfältig ausgewählten Materialien, elegantem Design und mit Respekt für Mensch und Umwelt. Sie verkörpert das authentische italienische Können, in dem Tradition und Innovation verschmelzen.





RICERCA, SVILUPPO & QUALITA'

RESEARCH & DEVELOPMENT . RECHERCHE ET DÉVELOPPEMENT . FORSCHUNG UND ENTWICKLUNG.

Il reparto R&D è il cuore dell'innovazione Sichenia. Attraverso ricerca continua e processi produttivi all'avanguardia, l'azienda realizza materiali che uniscono design, prestazioni tecniche e sostenibilità.

Ogni prodotto garantisce sicurezza, igiene e durata, confermando l'impegno verso la qualità totale.

Sichenia's R&D department is the driving force behind its innovation. Through continuous research and advanced production processes, the company develops materials that combine cutting-edge design, technical performance, and sustainability.

Every product ensures safety, hygiene, and durability, reflecting Sichenia's commitment to total quality.

Le département R&D de Sichenia est au cœur de son innovation. Grâce à une recherche constante et à des procédés de production avancés, l'entreprise conçoit des matériaux alliant design, performances techniques et durabilité.

Chaque produit garantit sécurité, hygiène et longévité, témoignant de l'engagement de Sichenia envers la qualité totale.

Die F&E-Abteilung von Sichenia ist das Herzstück der Innovation. Durch kontinuierliche Forschung und moderne Produktionsverfahren entwickelt das Unternehmen Materialien, die Design, technische Leistungsfähigkeit und Nachhaltigkeit vereinen.

Jedes Produkt steht für Sicherheit, Hygiene und Langlebigkeit und unterstreicht das umfassende Qualitätsversprechen von Sichenia.



20 MM SU OGNI FONDO E PER OGNI ESIGENZA SEMPRE IL MASSIMO RISULTATO.

20 mm. SUITABLE ON ANY BASE AND FOR ALL REQUIREMENTS, OFFERING MAXIMUM RESULTS.
20 mm. SUR TOUTE SOUS-COUCHE ET TOUTE EXIGENCE, TOUJOURS LES MEILLEURS RÉSULTATS.
20 mm. AUF JEDEM UNTERGRUND UND BEI ALLEN ERFORDERNISSEN STETS DAS HÖCHSTE ERGEBNIS.

Le lastre con spessore 20 mm nascono appositamente per risolvere le problematiche di arredo degli spazi esterni.

L'alto spessore consente una maggiore versatilità di posa senza l'utilizzo di collanti. Diventa quindi la soluzione perfetta per tutti gli ambienti in esterno con fondi in terra, ghiaia o sabbia.

La posa a colla con metodo tradizionale permette di ottenere superfici estremamente resistenti ideali per spazi soggetti al passaggio e allo stazionamento di autoveicoli. Inoltre le lastre Sichenia di 20 mm possono integrarsi con i sistemi di supporti per consentire di creare pavimentazioni sopraelevate capaci di alloggiare impianti.

The 20 mm thick slabs are designed to solve exterior design problems.

The high thickness offers greater laying versatility without the use of adhesives. It is therefore the ideal solution for exterior surfaces made of earth, gravel or sand.

With the conventional laying system using adhesive, it is possible to obtain extremely resistant surfaces, ideal for spaces subjected to vehicle traffic or parking. Sichenia's 20 mm thick slabs can also be used with support systems to create raised floors suitable to house cabling and piping.

Les dalles d'une épaisseur de 20 mm sont spécialement conçues pour résoudre les problèmes de la décoration des espaces extérieurs.

La grande épaisseur permet une meilleure polyvalence de pose sans l'utilisation de colles. Elle devient donc la solution parfaite pour tous les espaces extérieurs avec des substrats de terre, de gravier ou de sable.

La pose avec de la colle suivant la méthode traditionnelle permet d'obtenir des surfaces extrêmement résistantes, parfaites pour les espaces de passage et de stationnement de véhicules. En outre, les dalles Sichenia de 20 mm peuvent être intégrées aux systèmes de support pour permettre de créer des dallages surélevés capables de contenir des installations.

Die Platten mit einer Stärke von 20 mm wurden eigens entworfen, um Einrichtungsprobleme von Außenflächen zu lösen.

Die hohe Stärke ermöglicht eine größere Vielseitigkeit bei der Verlegung ohne Verwendung von Klebern. Sie stellen somit eine perfekte Lösung für alle Außenflächen mit Untergründen aus Erde, Kies und Sand dar.

Bei Verlegung mit der traditionellen Methode unter Einsatz von Klebern werden äußerst widerstandsfähige Flächen erzielt, die sich besonders gut für Böden eignen, die mit Fahrzeugen befahrenen und auf denen Fahrzeuge abgestellt werden.

Außerdem können die 20 mm-Platten von Sichenia mit Stützsystemen zur Schaffung von Doppelböden, mit Unterbringung von Anlagen, kombiniert werden.



- 1** Posa su massetto
Installation on screed
- 2** Posa a secco su ghiaia o sabbia
Dry installation on gravel or sand
- 3** Posa sopraelevata su solai
Raised installation on roofs
- 4** Posa su erba
Laying on grass



PALETTE CROMATICA

COLOR RANGE . NUANCIER. FARBPALETTE

Scopri l'ampiezza della gamma Sichenia attraverso il nostro abaco cromatico. Ogni immagine mostra i prodotti in tutte le tonalità disponibili, permettendoti di esplorare combinazioni, sfumature e materiali per dare forma a spazi unici e personalizzati.

Explore the full breadth of Sichenia's collection through our color chart. Each image showcases products in all available shades, allowing you to discover combinations, nuances, and materials to create unique, personalized spaces.

Découvrez l'étendue de la gamme Sichenia grâce à notre nuancier. Chaque image met en valeur les produits dans toutes les teintes disponibles, pour explorer combinaisons, nuances et matériaux et imaginer des espaces uniques et personnalisés.

Entdecken Sie die Vielfalt der Sichenia-Kollektion über unsere Farbpalette. Jede Abbildung zeigt die Produkte in allen verfügbaren Farbtönen und lädt dazu ein, Kombinationen, Nuancen und Materialien zu erkunden, um einzigartige, individuelle Räume zu gestalten.

STONEPIETRE

MYSTONE Sand	MYSTONE Silver				
ARDENNES Pearl	ARDENNES Cream	ARDENNES Nut	ARDENNES Grey		
CREMA LUNA Cream	CREMA LUNA Mist	CREMA LUNA Urban			
CHANTILLY Mélange	CHANTILLY Crème	CHANTILLY Beige	CHANTILLY Mélange de Nuit		
PAVÉ DELLE ALPI Sestriere	PAVÉ DELLE ALPI Quarzo Grigio	PAVÉ DELLE ALPI Quarzo Multicolore	PAVÉ DELLE ALPI Valmalenco	PAVÉ DELLE ALPI Porfido	PAVÉ DELLE ALPI Pietra Luserna
AMBOISE Beige	AMBOISE Grigio	AMBOISE Bianco	AMBOISE Oro		
AR_GENT Greige	AR_GENT Ash	AR_GENT Cream			
CHATEAUX Taupe	CHATEAUX Antracite				

MARBLEMARMI

NAVONA Bianco	NAVONA Beige
---------------	--------------

CONTEMPORARYCONTEMPORANEO

CON_CRET3 Bianco	CON_CRET3 Cappuccino	CON_CRET3 Grigio Basalto	CON_CRET3 Grigio Cenere	CON_CRET3 Beige
BLOCK Mud	BLOCK Grey	BLOCK Graphite		

WOODLEGNI

P_ARKETT Thun	P_ARKETT Graz	
SILVIS Rovere	SILVIS Larice	SILVIS Noce

ISPIRAZIONI

INSPIRATIONS . INSPIRATIONS . INSPIRATIONEN

Dove le superfici prendono vita.

Lasciati ispirare dalle nostre ambientazioni e scopri come le superfici Sichenia trasformano il tuo outdoor in uno spazio unico e personale.

Where surfaces come to life.

Be inspired by our settings and discover how Sichenia surfaces can transform your outdoor into a unique and personal space.

Là où les surfaces prennent vie.

Laissez-vous inspirer par nos ambiances et découvrez comment les surfaces Sichenia transforment votre plein air en un espace unique et personnel.

Wo Oberflächen zum Leben erwachen.

Lassen Sie sich von unseren Rauminszenierungen inspirieren und entdecken Sie, wie Sichenia-Oberflächen Ihr Zuhause in einen einzigartigen und persönlichen Raum verwandeln.



STONEPIETRE

18



MARBLEMARMI

44



CONTEMPORARYCONTEMPORANEO

52

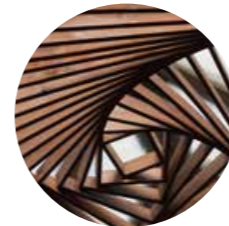

WOODLEGNI

60



STONEPIETRE

ELEGANZA, MATERICITÀ E RESISTENZA: RAPPRESENTAZIONE DI UN MATERIALE SENZA TEMPO.
ELEGANCE, MATERIALITY AND RESISTANCE: REPRESENTATION OF A TIMELESS MATERIAL.
ÉLÉGANCE, MATÉRIALITÉ ET RÉSISTANCE : REPRÉSENTATION D'UNE MATIÈRE INTEMPORELLE.
ELEGANZ, MATERIALITÄT UND WIDERSTANDSFÄHIGKEIT: DARSTELLUNG EINES ZEITLOSEN MATERIALS.

Il gres porcellanato Sichenia, propone realistiche interpretazioni delle pietre naturali.

La varietà dei colori e delle striature della pietra, unita al gres con spessore maggiorato 20mm, è ideale per rivestire terrazzi, porticati, scale, percorsi pedonali e carrabili.

Eleganza, matericità e resistenza, una rappresentazione tecnologica di un materiale senza tempo. Proposte pregiate in cui i dettagli delle texture definiscono superfici particolarmente raffinate, dalle sfumature omogenee oppure con stonalizzazioni decisamente intense.

Sichenia porcelain stoneware offers realistic interpretations of natural stones.

The variety of colors and streaks of the stone, combined with the 20mm thicker stoneware, is ideal for covering terraces, porches, stairs, footpaths and driveways.

Elegance, materiality and resistance, a technological representation of a timeless material. Precious proposals in which the details of the textures define particularly refined surfaces, with homogeneous shades or with decidedly intense color shading.

Le grès cérame Sichenia offre des interprétations réalistes des pierres naturelles.

La variété de couleurs et de rayures de la pierre, combinée au grès de 20 mm d'épaisseur, est idéale pour recouvrir les terrasses, les porches, les escaliers, les trottoirs et les allées.

Élégance, matérialité et résistance, une représentation technologique d'un matériau intemporel. Des propositions précieuses dans lesquelles les détails des textures définissent des surfaces particulièrement raffinées, avec des nuances homogènes ou avec des nuances de couleurs résolument intenses.

Das Feinsteinzeug von Sichenia bietet realistische Interpretationen von Natursteinen.

Die Vielfalt an Farben und Maserungen des Steins in Kombination mit dem 20 mm dickeren Steinzeug eignet sich ideal für die Abdeckung von Terrassen, Veranden, Treppen, Gehwegen und Einfahrten.

Eleganz, Materialität und Widerstandsfähigkeit, eine technologische Darstellung eines zeitlosen Materials. Kostbare Vorschläge, bei denen die Details der Texturen besonders raffinierte Oberflächen definieren, mit homogenen Farbtönen oder mit ausgesprochen intensiven Farbschattierungen.

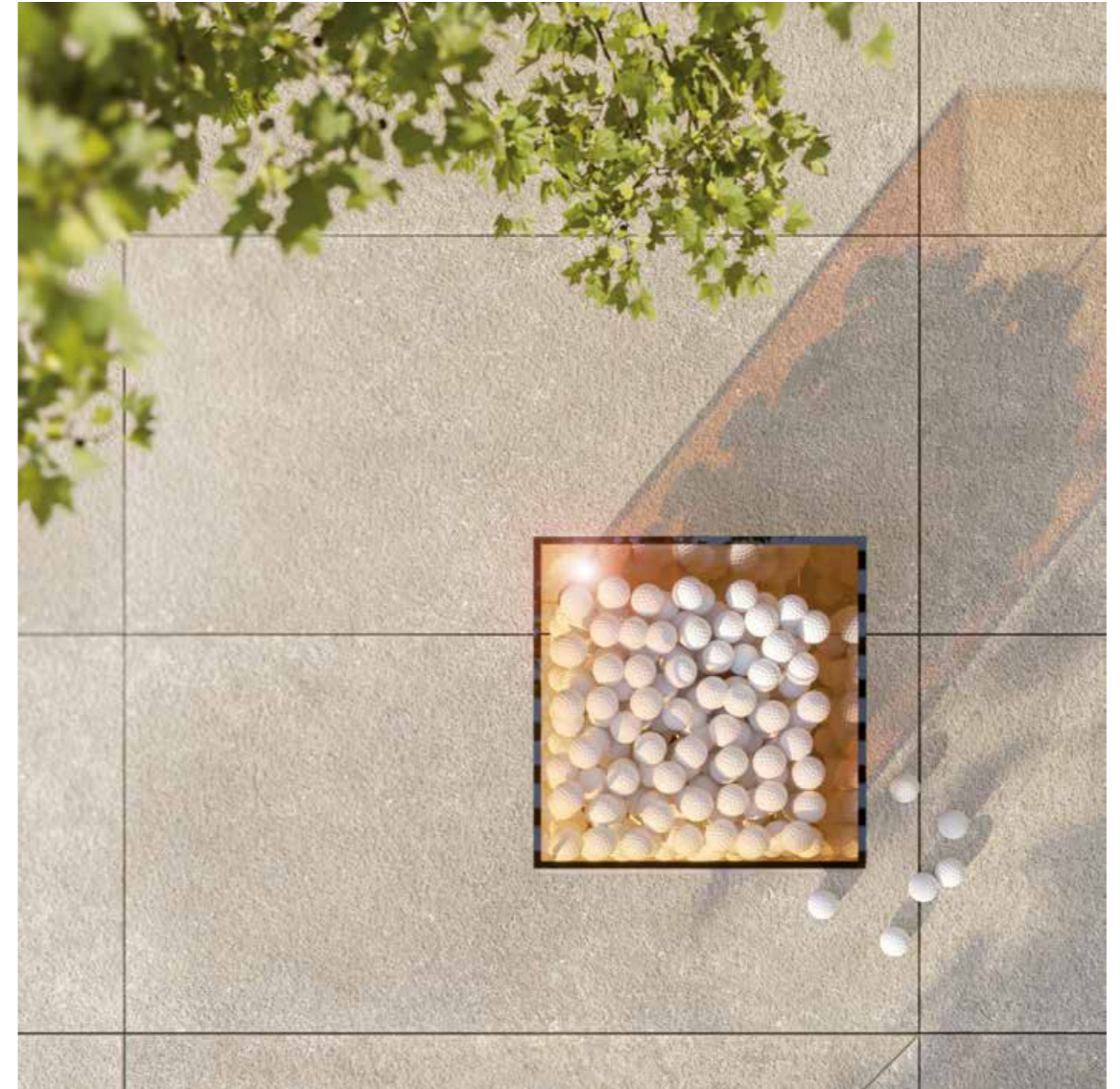

Collection CREMA LUNA

Pavimento . Floor - Indoor: Mist 60x120. 24"x48" Ret - MATT 9mm

Rivestimento . Wall Tile - Outdoor: Mist 60x120. 24"x48" Ret - MATT 9mm

Pavimento . Floor - Outdoor: Mist 60x120. 24"x48" Ret - GRIP 20mm / Gradino Costa Retta Mist Ret - GRIP 20mm / Angolo Interno Gradino Costa Ret - GRIP 20mm

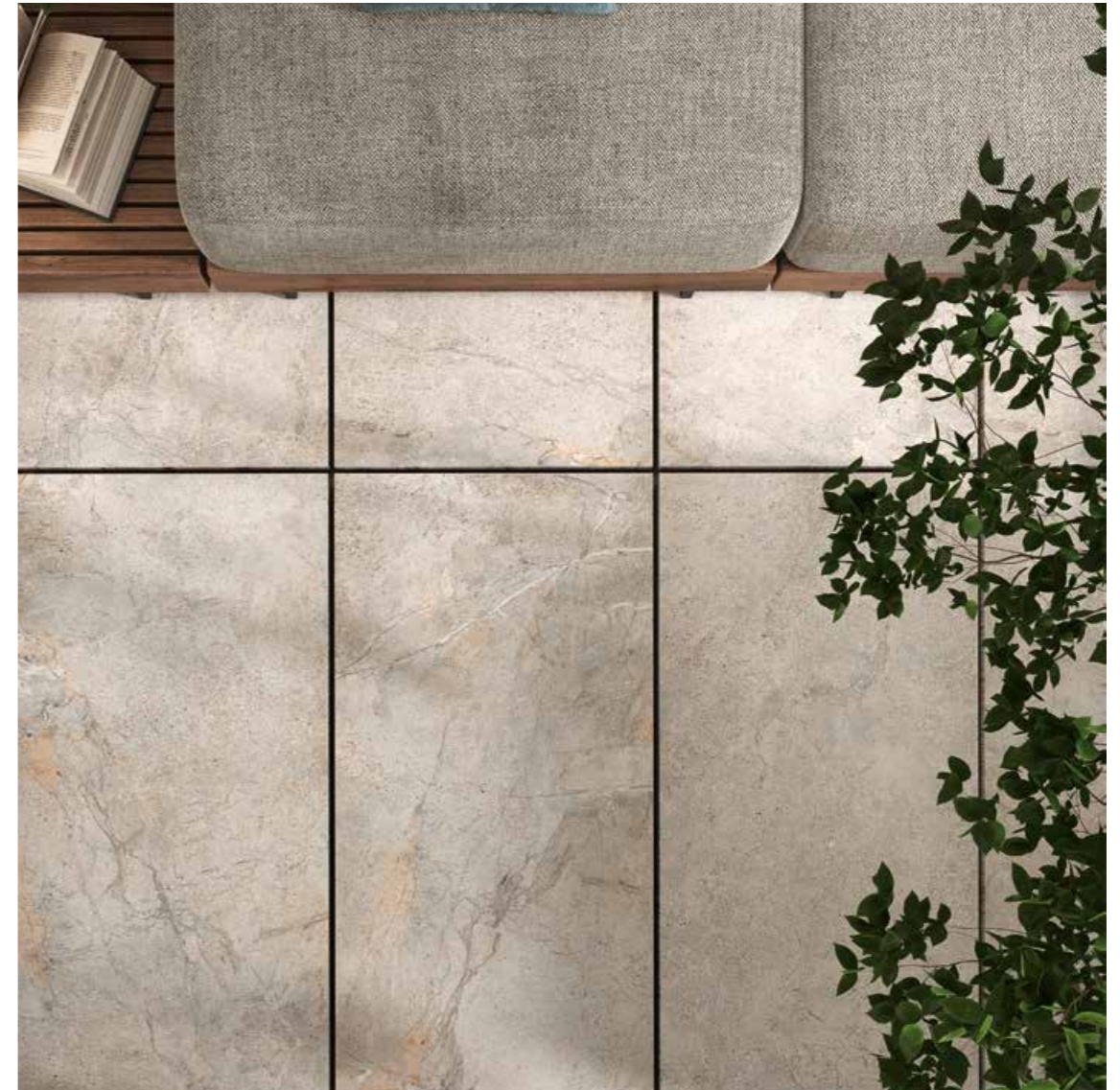

Collection MYSTONE
Pavimento . Floor
Sand 60x120 . 24"x48" Ret - GRIP 20mm

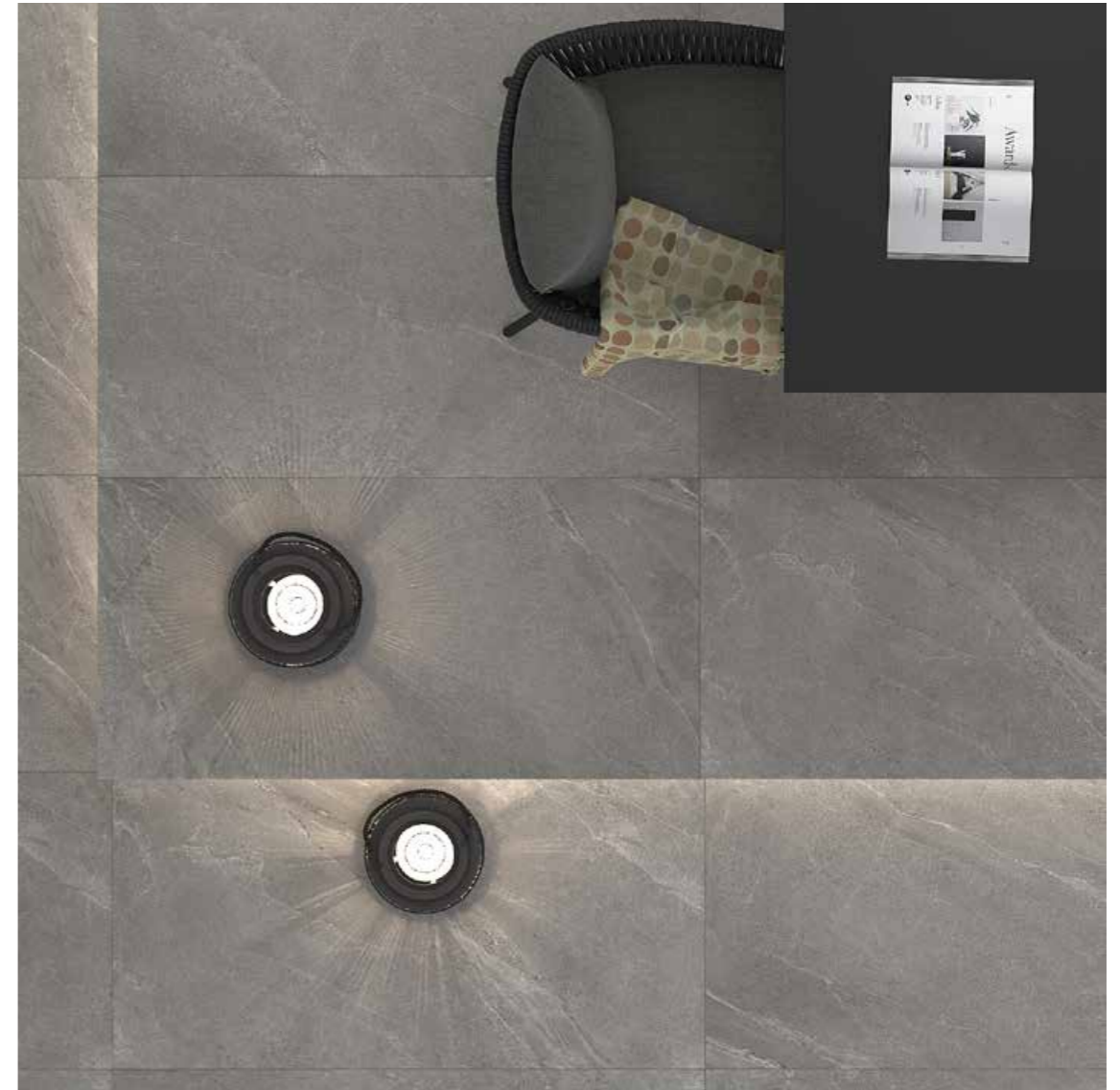

Collection ARDENNES
Pavimento . Floor
Grey 60x120 . 24"x48" Ret - GRIP 20mm
Gradino Costa Retta 33x120 . 13"x48" Ret - GRIP 20mm



Collection CHANTILLY
Pavimento . Floor:
Crème 60x90 . 24"x36" Chipped Ret - GRIP 20mm







Collection AMBOISE

Pavimento . Floor:

Oro 90x90 . 36"x36" Chipped Ret - GRIP 20mm

Gradino Costa Retta Oro 30x90 . 12"x36" Chipped Ret - GRIP 20mm

Angolo Est. Gradino Costa Retta Oro 30x30 . 12"x12" Chipped Ret - GRIP 20mm

Collection AMBOISE

Pavimento . Floor:

Oro 30x60 . 12"x24" Ret - SOFT GRIP 9mm

Bianco 60x90 . 24"x36" Chipped Ret - GRIP 20mm / Gradino Costa Retta Bianco 30x90 . 12"x36" Chipped Ret - GRIP 20mm

Oro 90x90 . 36"x36" Chipped Ret - GRIP 20mm



Collection AMBOISE
Pavimento . Floor:
Grigio 60x90 . 36"x36" Ret - Chipped GRIP 20mm
Gradino Costa Retta Grigio 33x60 . 13"x24" Chipped Ret - GRIP 20mm



Collection PAVE' WALLHOUSE
 Rivestimento . Wall:
 Graphite 16,5x41 . 6"x16" Muretto 10mm

Collection AR_GENT
 Pavimento . Floor:
 Ash 90x90 . 36"x36" Ret - GRIP 20mm / Gradino Costa Lucida Ash 60x90 . 24"x36" Ret - GRIP 20mm



Collection PAVÉ DELLE ALPI
Pavimento . Floor: Valmalenco 60x90 . 24"x36" Ret - GRIP 20mm
Rivestimento . Wall Tile:
Valmalenco 60x120 . 24"x48" Ret - SOFT GRIP 9mm

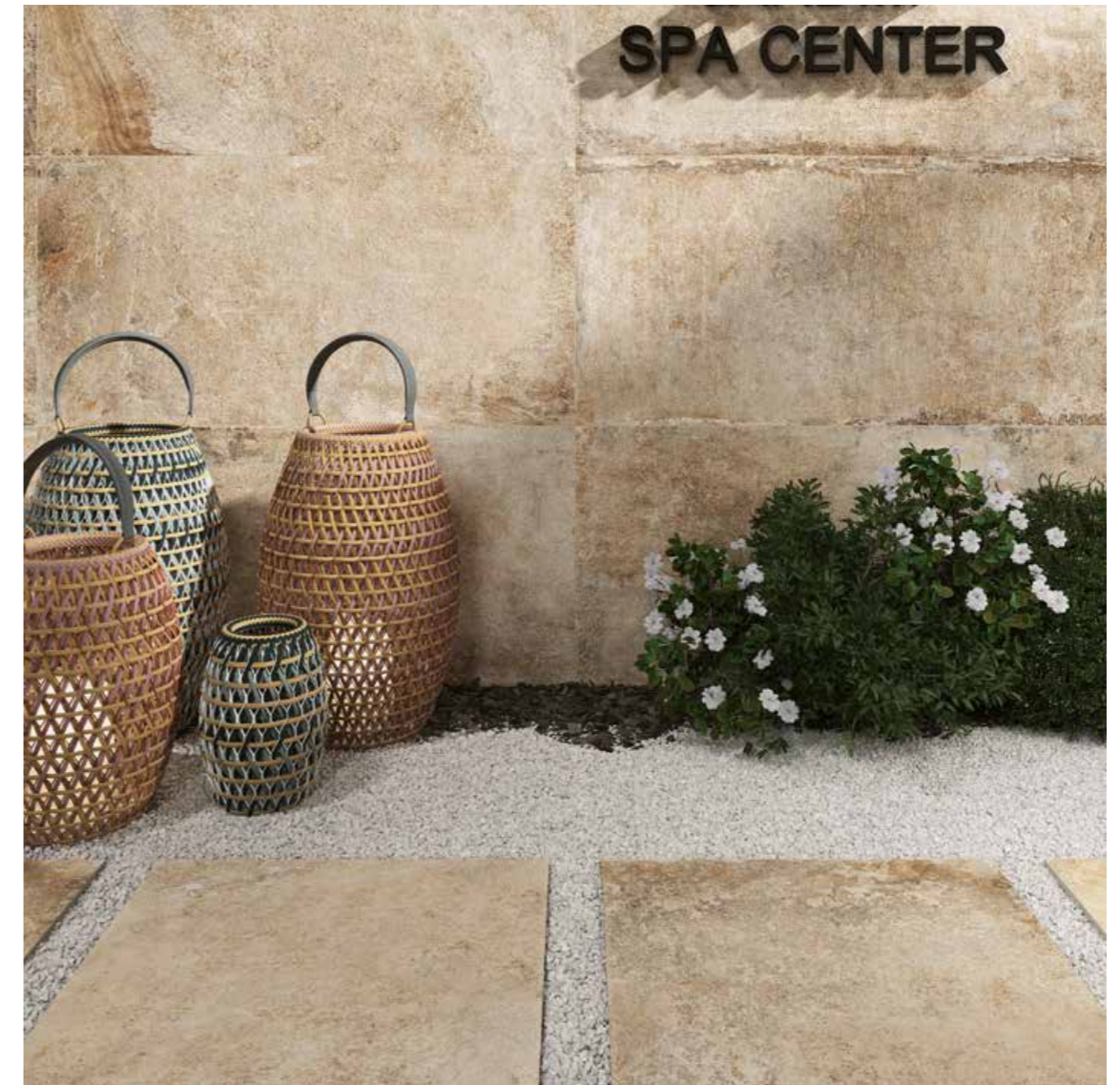

Collection PAVÉ DELLE ALPI

Pavimento . Floor:

Outdoor: Sestriere 60x90 . 24"x36" Ret - GRIP 20mm

Indoor: Sestriere 60x120 . 24"x48" Ret - SOFT GRIP 9mm

Rivestimento . Wall Tile: Sestriere 60x120 . 24"x48" Ret - SOFT GRIP 9mm



MARBLEMARM

UN MATERIALE DA SEMPRE PROTAGONISTA DELL'ARTE E DELL'ARCHITETTURA.

A MATERIAL THAT HAS ALWAYS BEEN THE PROTAGONIST OF ART AND ARCHITECTURE.

UN MAT.RIAU QUI A TOUJOURS .T. LE PROTAGONISTE DE L'ART ET DE L'ARCHITECTURE.

EIN MATERIAL, DAS SEIT JEHER DER PROTAGONIST VON KUNST UND ARCHITEKTUR IST.

Il marmo è da sempre protagonista dell'arte e dell'architettura.

La versione in gres porcellanato si presentacome valida alternativa al materiale naturale, sia per i costi più contenuti sia per la maggiore facilità di manutenzione.

Questo materiale è ideale per coloro che amano lo stile classico ma ricercato, dona agli ambienti un'aria di eleganza e raffinatezza.

Il gres a spessore maggiorato da 20 mm è ideale per rivestire i pavimenti degli spazi esterni con una superficie marmorea resistente, ingeliva, impermeabile e con finiture antiscivolo.

Sono varie le tonalità tra cui scegliere, con la sicurezza che rimangono inalterate nel tempo.

Marble has always been the protagonist of art and architecture.

The porcelain stoneware version is a valid alternative to the natural material, both for lower costs and for easier maintenance.

This material is ideal for those who love the classic but refined style, it gives the rooms an air of elegance and refinement.

The 20 mm thicker stoneware is ideal for covering the floors of outdoor spaces with a resistant, frost-proof, waterproof marble surface with non-slip finishes.

There are various shades to choose from, with the certainty that they remain unchanged over time.

Le marbre a toujours été le protagoniste de l'art et de l'architecture.

La version en grès cérame est une alternative valable au matériau naturel, à la fois pour des coûts moindres et pour un entretien plus facile.

Ce matériau est idéal pour ceux qui aiment le style classique mais raffiné, il donne aux pièces un air d'élégance et de raffinement.

Le grès de 20 mm d'épaisseur est idéal pour recouvrir les sols des espaces extérieurs d'une sur face en marbre résistante, antigel et imperméable avec des finitions antidérapantes.

Vous avez le choix entredifférentes nuances, avec la certitude qu'elles resteront inchangées dans le temps.

Marmor war schon immer der Protagonist von Kunst und Architektur.

Die Feinsteinzeug Version ist eine echte Alternative zum Naturmaterial, sowohl wegen der geringeren Kosten als auch wegen der einfacheren Wartung.

Dieses Material ist ideal für diejenigen, die den klassischen, aber raffinierten Stil lieben, es verleiht den Räumen einen Hauch von Eleganz und Raffinesse.

Das 20 mm dickere Steinzeug eignet sich ideal für den Bodenbelag im Außenbereich mit einer widerstandsfähigen, frostsicheren und wasserdichten Marmor Oberfläche mit rutschfester Oberfläche. Es stehen verschiedene Farbtöne zur Auswahl, mit der Gewissheit, dass diese im Laufe der Zeit unverändert bleiben.



Collection NAVONA

Pavimento . Floor

Beige 60x120 . 24"x48" Ret - SOFT GRIP 9mm

Beige 60x120 . 24"x48" Ret - GRIP 20mm

Gradino Costa Retta 33x120 - 13"x48"

Ret - GRIP 20mm

Rivestimento . Wall Tile:

Beige 20x60 . 8"x24"

Pavé Wall Muretto - ROWS 10mm



Collection NAVONA
Pavimento . Floor
Beige 60x120 . 24"x48" Ret - SOFT GRIP 9mm
Beige 60x120 . 24"x48" Ret - GRIP 20mm
Gradino Costa Retta 33x120 - 13"x48" Ret - GRIP 20mm



50

51



CONTEMPORARY CONTEMPORANEO

UNA RACCOLTA DI STILI DIFFERENTI PER POTER ESPRIMERE AL MEGLIO I PROPRI GUSTI

A COLLECTION OF DIFFERENT STYLES TO BETTER EXPRESS YOUR TASTES

UNE COLLECTION DE STYLES DIFFÉRENTS POUR MIEUX EXPRIMER VOS GOÛTS

EINE SAMMLUNG VERSCHIEDENER STILE, UM IHREN GESCHMACK BESSER ZUM AUSDRUCK ZU BRINGEN

Lo stile contemporaneo è associato a ricercate suggestioni materiche, un richiamo alla modernità che non manca di imporsi come tendenza.

In questa raccolta troviamo pavimenti di spessore 20mm con effetto cemento, metallo e trame decorative. L'effetto cemento è raffinato e sobrio ed è la soluzione più adatta a chi desidera un design moderno e delicato. L'effetto Metallo è caratterizzato dalle sfumature tipiche dell'ossidazione e la sua particolarità è data dalle forti colorazioni, ideale per chi cerca abbinamenti con altri materiali naturali (legno, cementi o pietre).

Particolarità di questa raccolta sono le trame realizzate in digitale sul gres porcellanato, pensate per arricchire il proprio dehor, creando ambienti originali e di forte impatto.

The contemporary style is associated with refined material suggestions, a reference to modernity that never fails to establish itself as a trend.

In this collection we find 20mm thick floors with a concrete effect, metal and decorative textures. The concrete effect is refined and sober and is the most suitable solution for those who want a modern and delicate design. The Metal effect is characterized by the typical nuances of oxidation and its peculiarity is given by the strong colours, ideal for those looking for combinations with other natural materials (wood, cement or stones).

A special feature of this collection are the textures created digitally on the porcelain stoneware, designed to enrich your outdoor area, creating original environments with a strong impact.

Le style contemporain est associé à des suggestions de matériaux raffinés, une référence à la modernité qui ne cesse de s'imposer comme une tendance.

Dans cette collection, nous trouvons des sols de 20 mm d'épaisseur avec un effet béton, du métal et des textures décoratives. L'effet béton est raffiné et sobre et est la solution la plus appropriée pour ceux qui veulent un design moderne et délicat. L'effet Métal se caractérise par les nuances typiques de l'oxydation et sa particularité est donnée par les couleurs fortes, idéales pour ceux qui recherchent des combinaisons avec d'autres matériaux naturels (bois, ciment ou pierres).

Une particularité de cette collection sont les textures créées numériquement sur le gres cérame, conçues pour enrichir votre espace extérieur, en créant des ambiances originales à fort impact.

Der zeitgenössische Stil ist mit raffinierten Materialvorschlägen verbunden, ein Hinweis auf die Moderne, der sich immer wieder als Trend etabliert.

In dieser Kollektion finden wir 20 mm dicke Böden mit Betoneffekt, Metall und dekorativen Texturen. Der Betoneffekt ist raffiniert und nüchtern und ist die am besten geeignete Lösung für diejenigen, die ein modernes und zartes Design wünschen. Der Metalleffekt zeichnet sich durch die typischen Nuancen der Oxidation aus und seine Besonderheit liegt in den kräftigen Farben, ideal für diejenigen, die Kombinationen mit anderen natürlichen Materialien (Holz, Zement oder Steinen) suchen.

Eine Besonderheit dieser Kollektion sind die digital auf dem Feinsteinzeug erzeugten Texturen, die Ihren Außenbereich bereichern und originelle Umgebungen mit starker Wirkung schaffen sollen.



54



55

Collection CON_CRETE
Pavimento . Floor: Indoor - Bianco 90x90 . 36"x36" Ret - Satin 9mm - Outdoor - Bianco 90x90 . 36"x 36" Ret - Grip 20mm
Rivestimento . Wall Tile: Collection Pavé Wall 30.90 Zebrino 30x90 . 12"x36" Ret - Rows 10mm



56



57

Collection CON_CRET3
Pavimento . Floor:
Bianco 90x90 . 36"x 36" Ret - GRIP 20mm
Grigio Cenere 60x60 . 24"x 24" Ret - GRIP 20mm



58

Collection BLOCK
Pavimento . Floor - Outdoor: Grey 60x60. 24"x24" Ret - GRIP 20mm
Pavimento . Floor - Indoor: Grey 60x60. 24"x24" Ret - R10 9mm



59

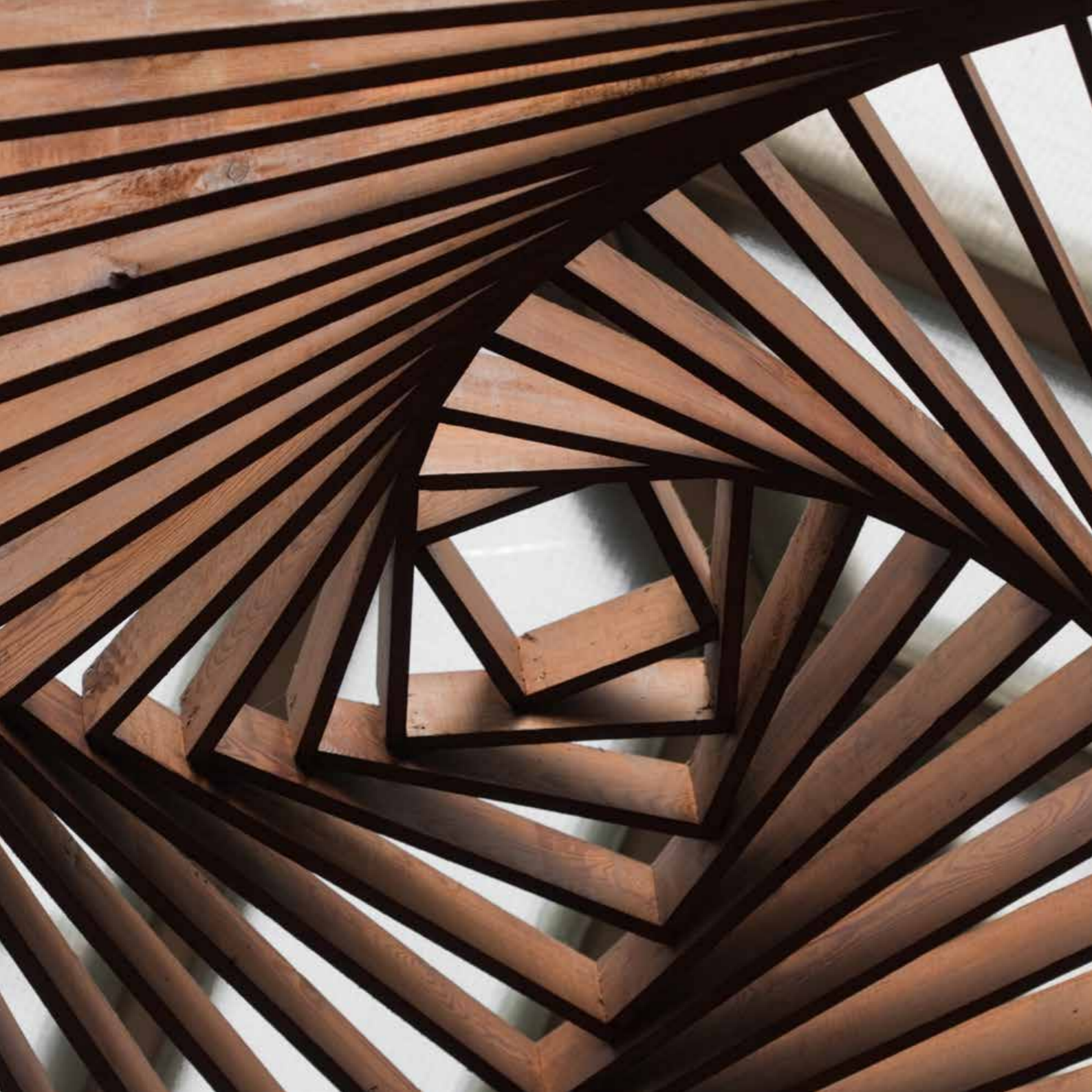

WOODLEGNI

LA BELLEZZA DEL LEGNO E I VANTAGGI DEL GRES PORCELLANATO PER GLI ESTERNI.

THE BEAUTY OF WOOD AND THE ADVANTAGES OF PORCELAIN STONEWARE FOR OUTDOORS.

LA BEAUTÉ DU BOIS ET LES AVANTAGES DU GRÈS CÉRAME POUR L'EXTÉRIEUR.

DIE SCHÖNHEIT VON HOLZ UND DIE VORTEILE VON FEINSTEINZEUG FÜR DEN AUSSENBEREICH.

Il legno è un materiale che muta nel tempo, cambiando nell'aspetto e qualche volta le sue qualità. Riprodurlo sulla ceramica richiede tecnologie produttive avanzate ma risolve diverse problematiche legate alla delicatezza del materiale naturale.

Le caratteristiche estetiche del legno, che ammorbidisce l'atmosfera, si uniscono ai vantaggi tecnici e di resistenza del gres porcellanato. Inoltre, anche se esposti al sole e agli agenti atmosferici, i colori del gres non cambiano nel tempo.

Wood is a material that changes over time, changing its appearance and sometimes its qualities. Reproducing it on ceramics requires advanced production technologies but solves various problems related to the delicacy of the natural material.

The aesthetic characteristics of wood, which softens the atmosphere, are combined with the technical and resistance advantages of porcelain stoneware. Furthermore, even when exposed to the sun and atmospheric agents, the colors of stoneware do not change over time.

Le bois est un matériau qui évolue avec le temps, modifiant son aspect et parfois ses qualités. Sa reproduction sur céramique nécessite des technologies de production avancées mais résout divers problèmes liés à la fragilité du matériau naturel.

Les caractéristiques esthétiques du bois, qui adoucissent l'atmosphère, sont associées aux avantages techniques et de résistance du grès cérame. De plus, même exposés au soleil et aux agents atmosphériques, les couleurs du grès ne changent pas avec le temps.

Holz ist ein Material, das sich im Laufe der Zeit verändert und sein Aussehen und manchmal auch seine Eigenschaften verändert. Die Reproduktion auf Keramik erfordert fortschrittliche Produktionstechnologien, löst jedoch verschiedene Probleme im Zusammenhang mit der Feinheit des natürlichen Materials.

Die ästhetischen Eigenschaften von Holz, das die Atmosphäre mildert, werden mit den technischen und widerstandsfähigen Vorteilen von Feinsteinzeug kombiniert. Darüber hinaus verändern sich die Farben von Steinzeug im Laufe der Zeit nicht, selbst wenn es der Sonne und Witterungseinflüssen ausgesetzt ist.



62



63

Collection P_ARKETT

Pavimento . Floor - Outdoor: Thun 40x120 . 16"x48" Ret - GRIP 20mm / Gradino costa retta 33x120 . 13"x48" Ret - GRIP 20mm

Angolo Est. Gradino Costa Retta 33x120 . 13"x48" Ret - GRIP 20mm / Griglia, Angolo Griglia 20x60 . 8"x24" Ret - GRIP 21mm

Pavimento . Floor - Indoor: Thun 30x120 . 12"x48" Ret - SATIN / 20x120 . 8"x48" Ret - SATIN 9mm

Rivestimento . Wall Tile: Bambus Mix 60x120 . 24"x48" Ret - SATIN 9mm



Collection SILVIS
Pavimento . Floor
Rovere 40x120 . 16"x48" Ret - GRIP 20mm
Outdoor - Noce 40x120 . 16"x48" Ret - GRIP 20mm
Indoor - Noce 20x120 . 8"x48" Ret - GRIP 9mm

COLLEZIONI

COLLECTION . COLLECTIONS . KOLLEKTIONEN



STONEPIETRE

ARDENNES	70
MY STONE	72
CHANTILLY	74
CREMA LUNA	76
PAVÉ DELLE ALPI	78
AMBOISE	82
AR_GENT	84
CHATEAUX	86



MARBLEMARMI

NAVONA	88
--------	----



CONTEMPORARYCONTEMPORANEO

CON_CRETE3	90
BLOCK	92

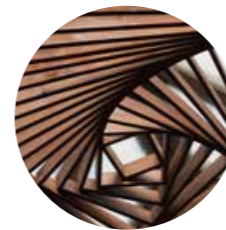

WOODLEGNI

P_ARKETT	94
SILVIS	98



PEARL



CREAM



NUT



GREY



71

Nut 60x120 . 24"x48" Ret - GRIP 20mm

ARDENNES



STONEPIETRE



60x120 . 24"x48"
Ret - GRIP

- 151091 - PEARL
- 151092 - CREAM
- 151093 - NUT
- 151094 - GREY



60x60 . 24"x24"
Ret - GRIP

- 151532 - CREAM
- 151533 - NUT



SVILUPPO GRAFICO / PATTERNS
 Facce differenti / Different Patterns
 60x120 **8**
 60x60 **16**



SAND



SILVER



Silver 60x120 . 24"x48" Ret - GRIP 20mm
Silver 60x120 . 24"x48" Ret - MATT 9mm

MYSTONE 

STONEPIETRE



60x120 . 24"x48"
Ret - GRIP

- 151412 - SAND
- 151413 - SILVER

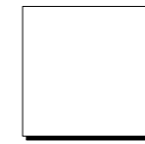

60x60 . 24"x24"
Ret - GRIP

- 151462 - SAND
- 151463 - SILVER



SVILUPPO GRAFICO / PATTERNS
Facce differenti / Different Patterns
60x120 **9**
60x60 **18**



CRÈME



BEIGE



MÉLANGE



MÉLANGE DE NUIT



75

Mélange 60x90 . 24"x36" Ret - GRIP 20mm

CHANTILLY



STONEPIETRE



60x90 . 24"x36"
Chipped Ret - GRIP

- 197782 - CRÈME
- 197783 - BEIGE
- 197784 - MÉLANGE
- 197785 - MÉLANGE DE NUIT

V3



SVILUPPO GRAFICO / PATTERNS
 Facce differenti / Different Patterns
 CRÈME / BEIGE 60x90 **28**

V4



SVILUPPO GRAFICO / PATTERNS
 Facce differenti / Different Patterns
 MÉLANGE / MÉLANGE DE NUIT
 60x90 **28**

"PRODOTTO CON MARCATA STONALIZZAZIONE CROMATICA"
 "PRODUCT WITH SIGNIFICANT SHADE VARIATION"
 PER UNA RESA ESTETICA MIGLIORE, È CONSIGLIABILE APRIRE
 DIVERSE SCATOLE CONTEMPORANEAMENTE E MESCOLARE
 PIASTRELLE PROVENIENTI DA SCATOLE DIVERSE.
 FOR A BETTER AESTHETIC INSTALLATION, IT IS ADVISABLE TO
 OPEN SEVERAL BOXES AT THE SAME TIME AND MIX TILES FROM
 DIFFERENT BOXES.



CREAM



MIST



URBAN



Cream 90x90 . 36"x36" Ret - GRIP 20mm
Gradino Costa Retta e Angolo Int. Gradino Costa Retta Cream Ret - GRIP 21mm
Griglia, Angolo Griglia Cream Ret - GRIP 21mm

CREMA LUNA



STONEPIETRE



90x90 . 36"x36"
Ret - GRIP

- 198172 - CREAM
- 198174 - MIST
- 198175 - URBAN

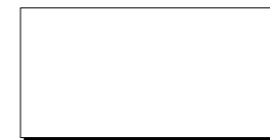

60x120 . 24"x48"
Ret - GRIP

- 198272 - CREAM
- 198274 - MIST
- 198275 - URBAN



60x60 . 24"x24"
Ret - GRIP

- 198702 - CREAM
- 198704 - MIST
- 198705 - URBAN



SVILUPPO GRAFICO / PATTERNS

Facce differenti / Different Patterns	
90x90	8
90x90	8
60x60	16



PIETRA LUSERNA



PORFIDO



VALMALENCO



Valmalenco 60x90 - 24"x36" Ret - GRIP 20mm

PAVÉ DELLE ALPI



STONEPIETRE



60x120 - 24"x48"
Ret - GRIP

15184A - PIETRA LUSERNA
151845 - PORFIDO



60x90 - 24"x36"
Ret - GRIP

19555A - PIETRA LUSERNA
185555 - PORFIDO
185556 - VALMALENCO



SVILUPPO GRAFICO / PATTERNS

Facce differenti / Different Patterns

PIETRA LUSERNA 60x90	8
PIETRA LUSERNA 60x120	8
VALMALENCO 60x90	10



SVILUPPO GRAFICO / PATTERNS

Facce differenti / Different Patterns

PORFIDO 60x90	12
PORFIDO 60x120	20



QUARZO MULTICOLORE



QUARZO GRIGIO



SESTRIERE



Floor: 30x60 . 12"x24" Ret - SOFT GRIP 14mm / 22,5x45 . 9"x18" GRIP 14mm / Gradini Costa Retta Lineare / Angolare 17x45 . 9"x18" / 60x90 . 24"x36" GRIP 20mm
Wall Tile: 10x60 . 4"x24" Muretto 10mm

81

PAVÉ DELLE ALPI



STONEPIETRE

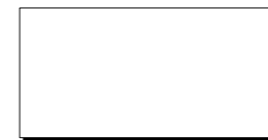

60x120 . 24"x48"
Ret - GRIP

151841 - SESTRIERE



60x90 . 24"x36"
Ret - GRIP

185553 - QUARZO MULTICOLORE
185552 - QUARZO GRIGIO
195551 - SESTRIERE



60x60 . 24"x24"
Ret - GRIP

195683 - QUARZO MULTICOLORE
195682 - QUARZO GRIGIO
195681 - SESTRIERE

V4



SVILUPPO GRAFICO / PATTERNS

Facce differenti / Different Patterns

QUARZO MULTICOLORE 60x90	30
QUARZO MULTICOLORE 60x60	30
SESTRIERE 60x120	14
SESTRIERE 60x90	28
SESTRIERE 60x60	42
QUARZO GRIGIO 60x90	12
QUARZO GRIGIO 60x60	14



BIANCO



BEIGE



ORO



GRIGIO



Oro 60x90 . 24"x36" Chipped Ret - GRIP 20mm

AMBOISE CHIPPED-EDGE



STONEPIETRE

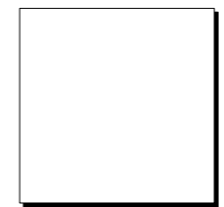

90x90 . 36"x36"
Chipped Ret - GRIP

- 192901 - BIANCO
- 192902 - BEIGE
- 192905 - ORO
- 192903 - GRIGIO



60x90 . 24"x36"
Chipped Ret - GRIP

- 192881 - BIANCO
- 192882 - BEIGE
- 192885 - ORO
- 192883 - GRIGIO



SVILUPPO GRAFICO / PATTERNS
 Facce differenti / Different Patterns
 BIANCO/BEIGE/GRIGIO
 90x90 **20**
 60x90 **24**



SVILUPPO GRAFICO / PATTERNS
 Facce differenti / Different Patterns
 ORO
 90x90 **20**
 60x90 **24**



CREAM



GREIGE



ASH



Ash 60x90 . 24"x36" Ret - GRIP 20mm / Gradino Costa Lucida Ash 60x90 . 24"x36" Ret - GRIP 20mm

AR_GENT



STONEPIETRE



90x90 . 36"x36"
Ret - GRIP

- 197122 - CREAM
- 186033 - GREIGE
- 186031 - ASH



SVILUPPO GRAFICO / PATTERNS
 Facce differenti / Different Patterns
 90x90 6



ANTRACITE



TAUPE



87

Taupe 60x90 . 24x36" Ret - GRIP 20mm

CHATEAUX



STONEPIETRE

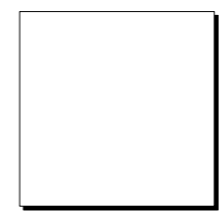

90x90 . 36"x36"
Ret - GRIP

- 182214 - ANTRACITE
- 182212 - TAUPE

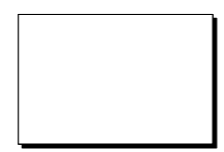

60x90 . 24"x36"
Ret - GRIP

- 182204 - ANTRACITE
- 182202 - TAUPE

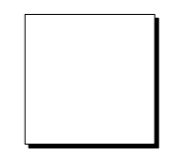

60x60 . 24"x24"
Ret - GRIP

- 181534 - ANTRACITE
- 181532 - TAUPE



SVILUPPO GRAFICO / PATTERNS
 Facce differenti / Different Patterns

90X90 TAUPE	7
90X90 ANTRACITE	6
60X60	24



BIANCO



BEIGE



89

Bianco 60x120 . 24x48" Ret - GRIP 20mm

NAVONA



MARMIMARBLE



60x120 . 24"x48"
Ret - GRIP

199621 - BIANCO
199622 - BEIGE



SVILUPPO GRAFICO / PATTERNS
Facce differenti / Different Patterns
60x120 10



BIANCO



BEIGE



CAPPUCCINO



GRIGIO CENERE

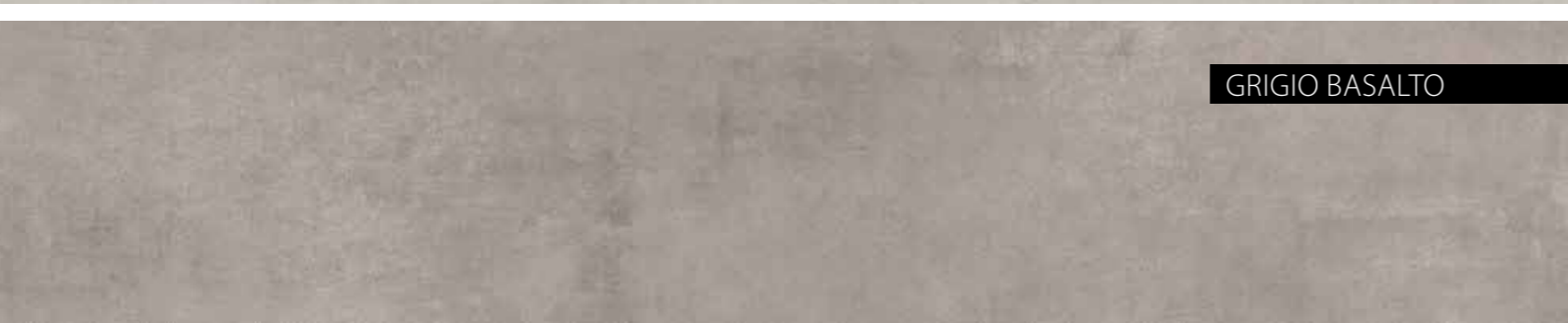

GRIGIO BASALTO



Grigio Basalto 90x90 . 36"x36" Ret - GRIP 20mm

CON_CRETE



CONTEMPORARY CONTEMPORANEO

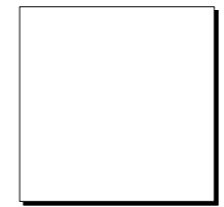

90x90 . 36"x36"
Ret - GRIP

- 197021** - BIANCO
- 197023** - CAPPUCCINO
- 197024** - GRIGIO CENERE
- 197025** - GRIGIO BASALTO

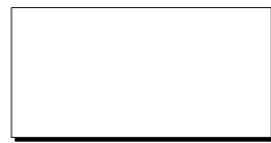

60x120 . 24"x48"
Ret - GRIP

- 196991** - BIANCO
- 196993** - CAPPUCCINO
- 196995** - GRIGIO BASALTO

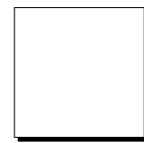

60x60 . 24"x24"
Ret - GRIP

- 196391** - BIANCO
- 196392** - BEIGE
- 196393** - CAPPUCCINO
- 196394** - GRIGIO CENERE
- 196395** - GRIGIO BASALTO

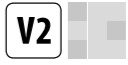

SVILUPPO GRAFICO / PATTERNS
 Facce differenti / Different Patterns

90x90	10
60x120	10
60x60	20



MUD



GREY



GRAPHITE



Graphite 90x90 . 36"x36" Ret - GRIP 20mm

BLOCK



CONTEMPORARY CONTEMPORANEO

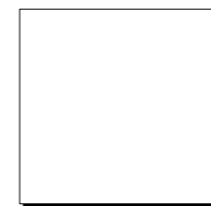

90x90 . 36"x36"
Ret - GRIP

- 180133 - MUD
- 180132 - GREY
- 180134 - GRAPHITE



60x60 . 24"x24"
Ret - GRIP

- 181293 - MUD
- 181292 - GREY
- 181294 - GRAPHITE



SVILUPPO GRAFICO / PATTERNS

Facce differenti / Different Patterns

90x90	7
60x60	14



THUN



GRAZ



Thun 40x120 . 16"x48" Ret - GRIP 20mm / Gradino Costa Retta Thun 33x120 . 13"x48" Ret - GRIP 20mm
Angolo Est. Gradino Costa Retta Thun Rett- GRIP 20mm / Griglia, Angolo Griglia 20x60 . 8"x24" Ret - GRIP 20mm

P. ARKETT



WOODLEGNI



40x120 . 16"x48"
Ret - GRIP

196142 - THUN
196144 - GRAZ



SVILUPPO GRAFICO / PATTERNS
Facce differenti / Different Patterns
40X120 28



ROVERE



LARICE



NOCE



Rovere 40x120 . 16"x48" Rett - GRIP 20mm

SILVIS 

WOODLEGNI

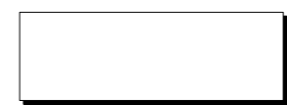

40x120 . 16"x48"
Ret - GRIP

- 181872 - ROVERE
- 181873 - LARICE
- 181875 - NOCE



SVILUPPO GRAFICO / PATTERNS
Facce differenti / Different Patterns
40X120 12



INFORMAZIONI TECNICHE

TECHNICAL INFORMATION . INFORMATION TECHNIQUE . TECHNISCHE INFORMATIONEN

Lo spessore 20mm **102**
Thickness 20mm.
Épaisseur 20mm.
Dicke 20mm.

Pavimentazioni sopraelevate **104**
Raised floors.
Dallages surélevés
Doppelböden

I pezzi speciali **106**
Trims.
Les pièces spéciales.
Die Formteile.

Caratteristiche tecniche **117**
Technical properties.
Caractéristiques techniques.
Technische Eigenschaften.

Destinazioni d'uso **117**
Intended uses.
Utilisations prévues.
Einsatzbereiche.

20 mm. SU OGNI FONDO E PER OGNI ESIGENZA SEMPRE IL MASSIMO RISULTATO.

20 mm. SUITABLE ON ANY BASE AND FOR ALL REQUIREMENTS, OFFERING MAXIMUM RESULTS.
20 mm. SUR TOUTE SOUS-COUCHE ET TOUTE EXIGENCE, TOUJOURS LES MEILLEURS RÉSULTATS.
20 mm. AUF JEDEM UNTERGRUND UND BEI ALLEN ERFORDERNISSEN STETS DAS HÖCHSTE ERGEBNIS.



4.

102



1.

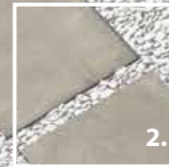

2.



3.



1

POSA SU MASSETTO. Per applicazioni carrabili o sottoposte a sollecitazioni eccezionali procedere alla posa del materiale incollandolo su massetto cementizio. Lasciare fuga minima di 2 mm e rispettare i giunti di dilatazione.

Installation on screed. For surfaces that will be used by vehicles or subject to very high stress, install the material by bonding it to cement screed. Leave a tile gap at least 2 mm and respect expansion joints.

Pose sur chape. Pour des applications pour véhicules ou soumises à des sollicitations exceptionnelles, poser le matériau en le collant sur une chape de ciment. Laisser des joints de 2 mm au moins et respecter les joints de dilatation.

Verlegung auf Estrich. Für befahrbaren oder außergewöhnlichen Belastungen ausgesetzte Anwendungen die Verlegung des Materials vornehmen, indem man es auf Zementestrich anklebt. Fugen von mindestens 2 mm lassen und die Dehnungsfugen einhalten.



3

POSA SOPRAELEVATA SU SOLAI. La posa sopraelevata su solai piani consente di realizzare pavimentazioni galleggianti su supporti distanziatori fissi, con regolazione manuale o con testina mobile. Grazie ai supporti di sopraelevazione si possono realizzare pavimenti con intercapedini di differenti altezze che garantiscono la ventilazione degli strati inferiori, l'assenza di muffe e umidità residua e una facile disposizione, manutenzione e modifica degli impianti.

Raised installation on roofs. With raised installation on flat, floating pavement can be built on fixed spacing supports, which can be adjusted manually or with a height adjuster. Thanks to the raised supports, pavements can be built with gaps at different heights that provide ventilation to the lower layers, thus preventing mold and residual moisture, and enable the pavement system to be arranged, maintained and modified with ease.

Pose surélevée sur toits. La pose surélevée sur toits plats permet de réaliser de revêtements de sol flottants sur des supports de séparation fixes, avec réglage manuel ou tête mobile. Grâce aux supports surélevée, des revêtements de sol avec des espaces de différentes hauteurs peuvent être réalisés, pour garantir la ventilation des couches inférieures, l'absence de moisissures et d'humidité résiduelle ainsi qu'une mise en place, un entretien et une modification faciles des installations.

Verlegung als Doppelboden auf Flächen. Ein überhöhtes Verlegen auf ebenen Zwischenböden ermöglicht einen schwimmenden Bodenbelag auf festen, einstellbaren Distanzstücken mit manueller Einstellung oder mit mobilem Kopf. Dank den Untergrundplatten können Böden mit unterschiedlich hohen Hohlräumen eingerichtet werden, in denen die unteren Schichten belüftet werden, wodurch Schimmel und Restfeuchten vermieden und ein leichtes Verlegen, Warten und Ändern der Anlagen gewährleistet werden.



2

POSA A SECCO SU GHIAIA O SABBIA. La posa a secco su ghiaia consente una facile applicazione sia su terreno che su solai piani di copertura. La posa è consigliata con l'utilizzo di ghiaia o sabbia con granulometria mista compresa tra 0,5 e 8 mm.

Dry installation on gravel or sand. Dry installation on gravel is simple on both the ground and on flat supports. We recommend using gravel or sand with a mixed granulometry of 0.5 to 8 mm.

Pose à sec sur gravier ou sable. La pose à sec sur gravier permet une application facile au sol et sur des toits des terrasses planes. Il est conseillé d'utiliser du gravier ou du sable d'une granulométrie mixte comprise entre 0.5 et 8 mm.

Verlegen auf Trockenem Kies oder Sand. Das Verlegen auf trockenem Kies ermöglicht eine leichte Anwendung Böden und ebenen Zwischenböden. Wird die Verwendung von Kies oder Sand mit mittlerer Korngröße zwischen 0,5 und 8 mm empfohlen.



4

POSA SU ERBA. La posa a secco su erba consente la realizzazione di camminamenti ed aree in grado di integrarsi sia con il verde circostante che con differenti contesti architettonici. Le destinazioni d'uso ideali sono i giardini, i vialetti ed i camminamenti residenziali ma anche quelli di parchi e spazi ricreativi pubblici.

Laying on grass. Dry laying on grass allows the creation of paths and areas that integrate well both with the surrounding landscaping and a variety of architectural contexts. Used in this way, is ideal not only for the gardens and paths of homes and residential complexes, but also for those of larger private and public parks and leisure areas.

Pose sur l'herbe. La pose à sec sur l'herbe permet la réalisation de sentiers et de zones s'accordant parfaitement aussi bien avec le vert environnant qu'avec de différents contextes architecturaux. Les domaines d'application idéaux sont les jardins, les allées et les sentiers résidentiels, mais également les parcs et espaces publics récréatifs.

Verlegung auf Gras. Die Trockenverlegung auf Gras ermöglicht das Anlegen von Trittsteinwegen und Flächen, die sich harmonisch in das umgebende Grün und das bauliche Umfeld einfügen. Ideale Anwendungsbereiche sind Gärten, Gehwege und Trittsteinwege in Wohnbereichen, Parks und Freizeitanlagen.

103



- | | | | |
|--|-------------------------------------|---|---|
| 1. Passaggio per impianti sempre ispezionabile | 1. Cavity for pipes easy inspection | 1. Passage pour installations contrôlable à tout moment | 1. Durchgänge für rohre können stets überprüft werden |
| 2. Materiale riciclato e riciclabile | 2. Recycled and recyclable material | 2. Matériau recyclé et recyclable | 2. Recyceltes und recycelbares material |
| 3. Auto-livellante | 3. Self-leveling | 3. Autonivelant | 3. Selbstregulierend |
| 4. Rapido deflusso d'acqua | 4. Fast water drainage | 4. Écoulement rapide de l'eau | 4. Schneller wasserabfluss |
| 5. Alleggerimento delle strutture | 5. Light system | 5. Allègement des structures | 5. Leichtes system |
| 6. Posa veloce | 6. Fast laying | 6. Pose rapide | 6. Schnelle verlegungverlegung |
| 7. Elevato carico a rottura | 7. High loading capacity | 7. Charge de rupture élevée | 7. Hohe bruchlast |
| 8. Isolamento termico | 8. Thermal insulation | 8. Isolation thermique | 8. Wärmeisolierung |
| 9. Isolamento acustico | 9. Acoustic insulation | 9. Isolation phonique | 9. Schallisolierung |
| 10. Assorbimento delle dilatazioni | 10. Absorption of dilatations | 10. Absorption des dilatations | 10. Dehnungsausgleich |

PAVIMENTAZIONI SOPRAELEVATE SICHENIA

SICHENIA RAISED FLOORS.
DALLAGES SURÉLEVÉS SICHENIA.
SICHENIA-DOPPELBÖDEN.

Le proprietà delle lastre in gres porcellanato con spessore 20 mm di Sichenia consentono di essere abbinare a sistemi di supporti di sostegno in polipropilene.

I supporti sono regolabili e permettono di realizzare pavimenti sopraelevati perfettamente planari che consentono il passaggio di impianti elettrici e idrici.

The 20 mm thick porcelain stoneware slabs by Sichenia are suitable to be combined with propylene support systems.

The supports are adjustable in order to create perfectly flat raised floors that allow the passage of plumbing and electrical systems.

Les propriétés des dalles en grès cérame d'une épaisseur de 20 mm de Sichenia permettent de les associer à des systèmes de support en polypropylène.

Les supports sont réglables et permettent de réaliser des dallages surélevés parfaitement horizontaux favorisant le passage d'installations électriques et hydriques.

Aufgrund ihrer besonderen Eigenschaften können die Sichenia-Platten aus Feinsteinzeug, mit einer Stärke von 20 mm, mit Stützsyste men aus Polypropylen kombiniert werden.

Die Stützen sind regelbar und ermöglichen die Schaffung von hundertprozentig ebenen Doppelböden, unter denen Elektro- und Wasseranlagen untergebracht werden können.

I VANTAGGI DI UN PAVIMENTO SOPRAELEVATO

THE ADVANTAGES OF A RAISED FLOOR:
LES AVANTAGES D'UN DALLAGE SURÉLEVÉ:
VORTEILE VON DOPPELBÖDEN:

- | | | | |
|---|--|--|---|
| • Risolve i problemi di livellamento. | • Solves levelling problems. | • Elle résout les problèmes de nivellement. | • Beseitigung von Nivellierungsproblemen. |
| • Permette l'alloggiamento di impianti elettrici e tubazioni. | • Allows space to house electrical systems and piping. | • Elle permet l'intégration de circuits électriques et de conduites. | • Möglichkeit zur Unterbringung von Elektroanlagen und Rohrleitungen. |
| • Facile da ispezionare. | • Easy to inspect. | • Facile à inspecter. | • Einfache Überprüfung. |
| • Immediato drenaggio dell'acqua piovana. | • Immediate drainage of rain water. | • Drainage immédiat de l'eau de pluie. | • Unverzögliche Drainage des Regenwassers. |
| • Resistenza alla dilatazione termica. | • Resistance to thermal expansion. | • Résistance à la dilatation thermique. | • Beständigkeit gegen Wärmedehnung. |
| • Migliora l'isolamento termico e acustico. | • The system is assembled without adhesives. | • Meilleure isolation thermique et acoustique. | • Verbesserung der thermischen und akustischen Isolierung. |
| • Il sistema si assembla senza collanti. | • Significantly reduces installation time and costs. | • On assemble le système sans colles. | • Verlegung des Systems ohne Kleber. |
| • Riduce sensibilmente i tempi e i costi dell'opera. | • Reusable and replaceable. | • Réduit sensiblement les temps et les coûts de l'ouvrage. | • Merkliche Verminderung der Verlegezeiten und -kosten. |
| • Riutilizzabile e sostituibile. | • The absence of a screed reduces the load. | • Réutilisable et remplaçable. | • Wiederverwend- und auswechselbar. |
| • L'assenza della base in massetto determina la riduzione del carico. | | • L'absence de la chape de base détermine la réduction de la charge. | • Verminderung der Last aufgrund der Abwesenheit des Untergrunds aus Estrich. |

I PEZZI SPECIALI COSTA LUCIDA

SPECIAL PIECES.
PIÈCES SPÉCIALES.
SPEZIALTEILE.



Gradino costa lucida



Gradino costa lucida Angolo Interno Dx-Sx



Gradino costa lucida Angolo Esterno Dx-Sx

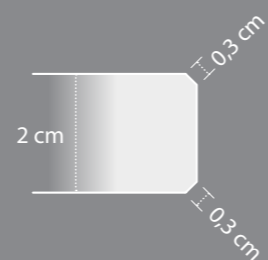

106

107



- . Su richiesta possono essere realizzati pezzi con gocciolatoio e/o con fresature antiscivolo.
- . Bord antidérapant avec goutte à goutte.
- . Auf Anfrage können die Stufenelemente mit Tropfnase oder/und antislip Rillen hergestellt werdenhergestellt werden.
- . Drip and anti-slip grooves can be made.



I PEZZI SPECIALI TORO

SPECIAL PIECES.
PIÈCES SPÉCIALES.
SPEZIALTEILE.



Gradino Toro



Gradino Toro - Angolo Interno Dx-Sx



Gradino Toro - Angolo Esterno Dx-Sx

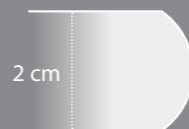

2 cm

108

109



- . Su richiesta possono essere realizzati pezzi con gocciolatoio e/o con fresature antiscivolo.
- . Bord antidérapant avec goutte à goutte.
- . Auf Anfrage können die Stufenelemente mit Tropfnase oder/und antislip Rillen hergestellt werdenhergestellt werden.
- . Drip and anti-slip grooves can be made.



I PEZZI SPECIALI COSTA RETTA

SPECIAL PIECES.
PIÈCES SPÉCIALES.
SPEZIALTEILE.



Gradino Costa Retta



Gradino Costa Retta Angolo Interno



Gradino Costa Retta Angolo Esterno

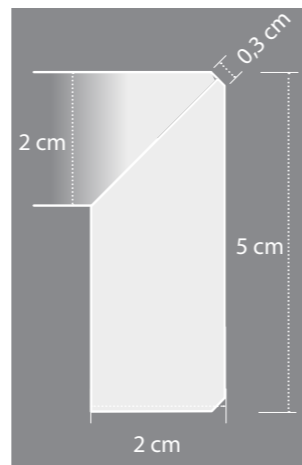

110

111

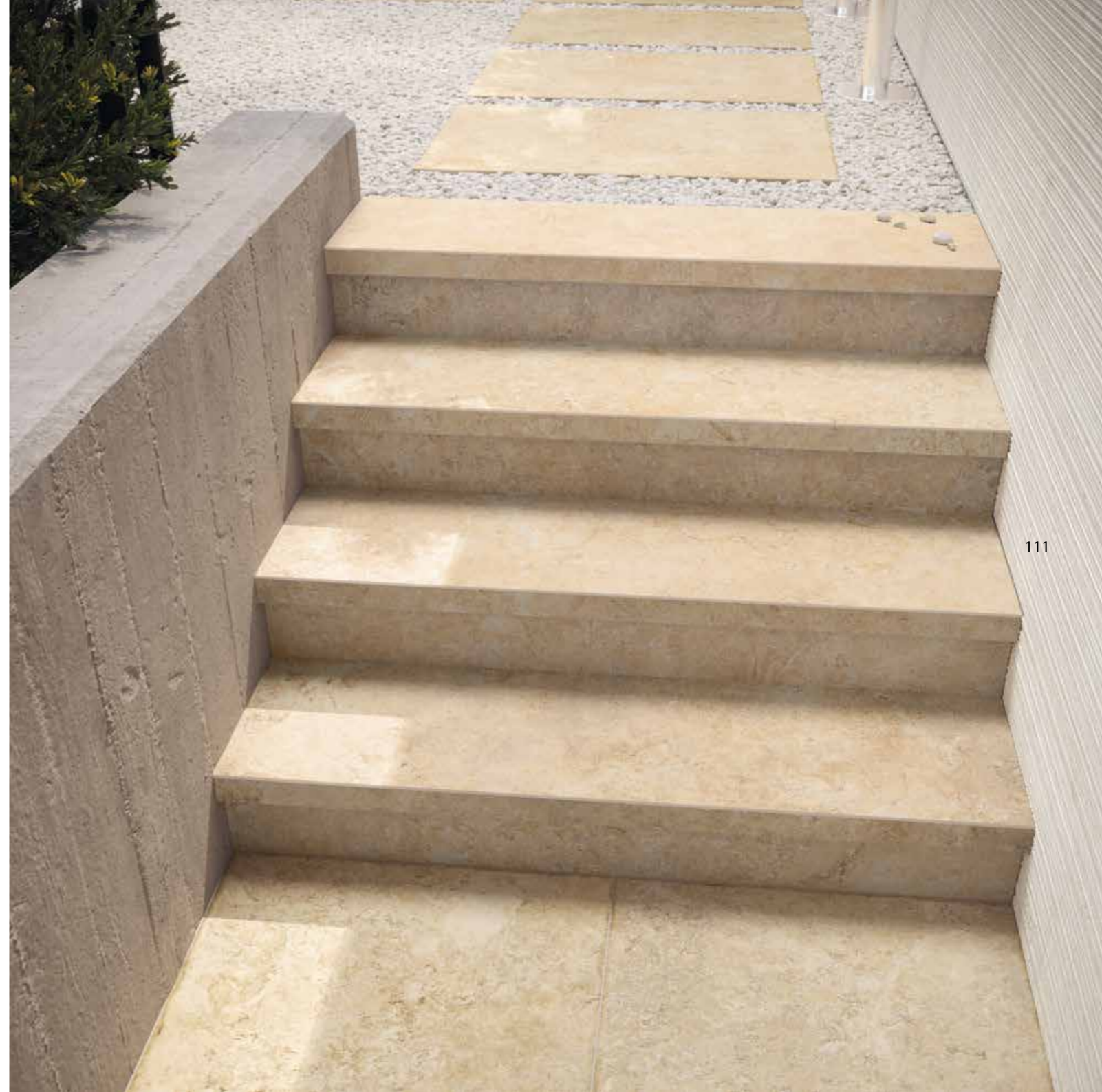

I PEZZI SPECIALI COPERTINA

SPECIAL PIECES.
PIÈCES SPÉCIALES.
SPEZIALTEILE.



Copertina con gocciolatoio

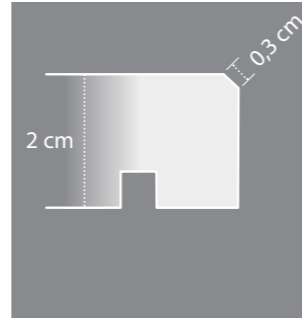

A disposizione su richiesta.
Available upon request.
Disponible sur demande.
Auf Anfrage verfügbar.

112

I PEZZI SPECIALI GRIGLIA

SPECIAL PIECES.
PIÈCES SPÉCIALES.
SPEZIALTEILE.



Griglia

Spessore 2,1cm
N.B.: Essendo di spessori leggermente diversi, il fondo va compensato in posa.
N.B.: Tile and grid are of different thickness so they must be compensated with the laying.
N.B.: les unis et les grilles ont une épaisseur différente, donc, il faudra la compenser lors de la pose.
N.B.: Unifliese und Gitter haben unterschiedlichen dicke, daher müssen beim Einbau ausgeglichen werden.



Angolo griglia Dx-Sx

A disposizione su richiesta.
Available upon request.
Disponible sur demande.
Auf Anfrage verfügbar.





113



I PEZZI SPECIALI





SPECIAL PIECES.
PIÈCES SPÉCIALES.
SPEZIALTEILE.

STONEPIETRE

 Gradino Costa Retta	 Angolo Int. Gradino Costa Retta	 Angolo Est. Gradino Costa Retta			
33x120. 13"x48" Ret - Grip	33x120. 13"x48" Ret - Grip	33x33. 13"x13" Ret - Grip			
ARDENNES					
151541 - Pearl 151542 - Cream 151543 - Nut 151544 - Grey	151561 - Pearl 151562 - Cream 151563 - Nut 151564 - Grey	151571 - Pearl 151572 - Cream 151573 - Nut 151574 - Grey			
33x120. 13"x48" Ret - Grip	33x120. 13"x48" Ret - Grip	33x33. 13"x13" Ret - Grip			
CREMA LUNA					
198282 - Cream 198284 - Mist 198285 - Urban	198292 - Cream 198294 - Mist 198295 - Urban	198302 - Cream 198304 - Mist 198305 - Urban			
33x90 . 13"x36" Chipped Ret - Grip	33x90 . 13"x36" Chipped Ret - Grip	33x33 . 13"x13" Chipped Ret - Grip			
CHANTILLY					
197942 - Crème 197943 - Beige 197944 - Mélange 197945 - Mélange de Nuit	197952 - Crème 197953 - Beige 197954 - Mélange 197955 - Mélange de Nuit	197962 - Crème 197963 - Beige 197964 - Mélange 197965 - Mélange de Nuit			
33x60 . 13"x24" Ret - Grip	33x60 . 13"x24" Ret - Grip	33x33 . 13"x13" Ret - Grip			
PAVE' DELLE ALPI					
19559A - Pietra Luserna 195591 - Sestriere 195592 - Quarzo Grigio 195593 - Q. Multicolore 195596 - Valmalenco 195595 - Porfido	19560A - Pietra Luserna 195601 - Sestriere 195602 - Quarzo Grigio 195603 - Q. Multicolore 195606 - Valmalenco 195605 - Porfido	19561A - Pietra Luserna 195611 - Sestriere 195612 - Quarzo Grigio 195613 - Q. Multicolore 195616 - Valmalenco 195615 - Porfido			
33x90 . 13"x36" Chipped Ret - Grip	33x90 . 13"x36" Chipped Ret - Grip	33x33 . 13"x13" Chipped Ret - Grip			
AMBOISE					
192911 - Bianco 192912 - Beige 192915 - Oro 192913 - Grigio	192921 - Bianco 192922 - Beige 192925 - Oro 192923 - Grigio	192931 - Bianco 192932 - Beige 192935 - Oro 192933 - Grigio			

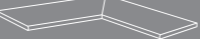

114

STONEPIETRE

 Gradino Toro	 Angolo Grad. Toro Int. Dx-Sx	 Angolo Grad. Toro Est. Dx-Sx	 Gradino Costa Lucida	 Angolo Grad. Costa Lucida Int. Dx-Sx	 Angolo Grad. Costa Lucida Est. Dx-Sx
30x90 . 12"x36" Ret - Grip	30x90 . 12"x36" Ret - Grip	30x90 . 12"x36" Ret - Grip	30x90 . 12"x36" Ret - Grip	30x90 . 12"x36" Ret - Grip	30x90 . 12"x36" Ret - Grip
AR_GENT					
185073 - Greige 185071 - Ash 185072 - Cream	185083 - Greige 185081 - Ash 185082 - Cream	185093 - Greige 185091 - Ash 185092 - Cream	185103 - Greige 185101 - Ash 185102 - Cream	185113 - Greige 185111 - Ash 185112 - Cream	185123 - Greige 185121 - Ash 185122 - Cream
30x90 . 12"x36" Ret - Grip	30x90 . 12"x36" Ret - Grip	30x90 . 12"x36" Ret - Grip	30x90 . 12"x36" Ret - Grip	30x90 . 12"x36" Ret - Grip	30x90 . 12"x36" Ret - Grip
CHATEAUX					
184244 - Antracite 184242 - Taupe	184254 - Antracite 184252 - Taupe	184264 - Antracite 184262 - Taupe	184274 - Antracite 184272 - Taupe	184284 - Antracite 184282 - Taupe	184294 - Antracite 184292 - Taupe

115

MARBLEMARMI

 Gradino Costa Retta	 Angolo Int. Gradino Costa Retta	 Angolo Est. Gradino Costa Retta			
33x120. 13"x48" Ret - Grip	33x120. 13"x48" Ret - Grip	33x33. 13"x13" Ret - Grip			
NAVONA					
199651 - Bianco 199652 - Beige	199661 - Bianco 199662 - Beige	199671 - Bianco 199672 - Biege			

CONTEMPORARY CONTEMPORANEO

33x60 . 13"x24" Ret - Grip	33x60 . 13"x24" Ret - Grip	33x33 . 13"x13" Ret - Grip			
CONCRETE					
196441 - Bianco 196442 - Beige 196443 - Cappuccino 196444 - Grigio Cenere 196445 - Grigio Basalto	196451 - Bianco 196452 - Beige 196453 - Cappuccino 196454 - Grigio Cenere 196455 - Grigio Basalto	196461 - Bianco 196462 - Beige 196463 - Cappuccino 196464 - Grigio Cenere 196465 - Grigio Basalto			
30x90 . 12"x36" Ret - Grip	30x90 . 12"x36" Ret - Grip	30x90 . 12"x36" Ret - Grip	30x90 . 12"x36" Ret - Grip	30x90 . 12"x36" Ret - Grip	30x90 . 12"x36" Ret - Grip
BLOCK					
184123 - Mud 184122 - Grey 184124 - Graphite	184133 - Mud 184132 - Grey 184134 - Graphite	184143 - Mud 184142 - Grey 184144 - Graphite	184153 - Mud 184152 - Grey 184154 - Graphite	184163 - Mud 184162 - Grey 184164 - Graphite	184173 - Mud 184172 - Grey 184174 - Graphite

116

WOOD LEGNO

33x120 . 13"x48" Ret - Grip	33x120 . 13"x48" Ret - Grip	33x33 . 13"x13" Ret - Grip			
P_ARKETT					
196192 - Thun 196194 - Graz	196202 - Thun 196204 - Graz	196212 - Thun 196214 - Graz			
40x120 . 16"x48" Ret - Grip	40x120 . 16"x48" Ret - Grip	40x120 . 16"x48" Ret - Grip	40x120 . 16"x48" Ret - Grip	40x120 . 16"x48" Ret - Grip	40x120 . 16"x48" Ret - Grip
SHER_WOOD					
188524 - Honey 188523 - Red Brown	188534 - Honey 188533 - Red Brown	188544 - Honey 188543 - Red Brown	188554 - Honey 188553 - Red Brown	188564 - Honey 188563 - Red Brown	188574 - Honey 188573 - Red Brown
40x120 . 16"x48" Ret - Grip	40x120 . 16"x48" Ret - Grip	40x120 . 16"x48" Ret - Grip	40x120 . 16"x48" Ret - Grip	40x120 . 16"x48" Ret - Grip	40x120 . 16"x48" Ret - Grip
SILVIS					
184362 - Rovere 184363 - Larice 184365 - Noce	184372 - Rovere 184373 - Larice 184375 - Noce	184382 - Rovere 184383 - Larice 184385 - Noce	184392 - Rovere 184393 - Larice 184395 - Noce	184402 - Rovere 184403 - Larice 184405 - Noce	184412 - Rovere 184413 - Larice 184415 - Noce

CARATTERISTICHE TECNICHE DI SUPERFICIE | SURFACE TECHNICAL CHARACTERISTICS

Conforme alla norma EN 1441 1 Appendice G gruppo Bla Conforme alla norma ISO 13006 Appendice G gruppo Bla
Compliant with standards EN 14411 annex G group Bla Compliant with standards ISO 13006 annex G group Bla

Bordi Edges. Bords. Kanten.	Spessore Thickness. Épaisseur. Stärke.	Resistenza allo scivolamento Slip resistance. Résistance au glissement. Rutschfestigkeit.					Resistenza alle macchie (Pulibilità) Resistance to staining. Résistance aux produits tachants. Flecken Beständigkeit.	Resistenza agli acidi e alle basi Resistance to acids and bases. Résistance aux acides et aux bases. Beständigkeit gegen Säuren und Laugen.		
		DIN EN 16165 Annex B	DIN EN 16165 Annex A	AS/NZS 4586	BS EN 16165	UNE-ENV 12633	B.C.R.A. Rep. CEC/81	DCOF Ansi A 326.3	ISO 10545/14	ISO 10545/13
rettificati	20 mm	R11	A+B+C	P4	≥ 36 Wet	Classe C3	> 0,40	≥ 0,62 Wet	5	A . LA . HA

DESTINAZIONE D'USO CONSIGLIATE

Examples of applications suggested. Domaines d'utilisation conseillés. Empfohlene Anwendungsbereiche

TERRAZZE TERRACES	STABILIMENTI BALNEARI BEACH RESORTS	PARCHEGGI PARKING AREAS	AREE URBANE URBAN AREAS	ZONE INDUSTRIALI INDUSTRIAL AREAS	CAMMINAMENTI PISCINE POOL DECKS	GIARDINI PARCHI PUBBLICI GARDENS - PUBLIC PARKS

117

Seguici sui nostri social
Follow us



Linkedin



Instagram



Facebook

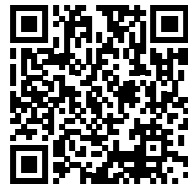

Iscriviti alla nostra Newsletter
Subscribe to our Newsletter



Consigli di posa
Installation tips



Condizioni generali di vendita
General Sales Conditions

MADE IN ITALY



La riproduzione, la pubblicazione, e la distribuzione, totale o parziale, di tutto il materiale originale contenuto in questo documento sono espressamente vietate in assenza di autorizzazione da parte di Sichenia. Sichenia si riserva di modificare i prodotti senza preavviso, declinando ogni responsabilità relativa a danni diretti o indiretti derivanti da tali modifiche. I colori e le caratteristiche estetiche dei materiali illustrati nel presente catalogo sono da ritenersi puramente indicativi. Per le informazioni e i dati relativi ai codici, imballaggi e pesi occorre sempre consultare l'ultimo listino aggiornato e in vigore.

The reproduction, publication, and distribution, total or partial, of all the original material contained herein is expressly prohibited without the prior consent of Sichenia. Sichenia reserves the right to make changes to the products without notice, and shall not be liable for any direct or indirect damages arising from any changes. The colours and the aesthetic characteristics of the products shown in this catalogue are purely illustrative. For information and data concerning codes, packaging and weight always refer to the last updated price list in force.

La reproduction, la publication et la distribution, totales ou partielles, de tout le matériel original contenu dans ce document sont expressément interdites sans l'autorisation de Sichenia. Sichenia se réserve la faculté de modifier les produits sans préavis, en déclinant toute responsabilité relative à des dommages directs ou indirects dérivant d'éventuelles modifications. Les couleurs et les caractéristiques esthétiques du matériel illustré dans ce catalogue sont fournis à titre purement indicatif. Pour les informations et les données relatives aux codes, aux emballages et aux poids, il est toujours nécessaire de consulter le dernier tarif mis à jour et en vigueur.

Die vollständige oder auszugsweise Vervielfältigung, Veröffentlichung und Verbreitung des gesamten, in diesem Dokument enthaltenen Originalmaterials, ist ohne Genehmigung der Firma Sichenia ausdrücklich untersagt. Sichenia behält sich das Recht vor, die Produkte ohne vorherige Ankündigung zu ändern und haftet nicht für direkte oder indirekte, durch eventuelle Änderungen verursachte Schäden. Die Farben und ästhetischen Merkmale des im vorliegenden Katalogs abgebildeten Materials sind rein zur Information und nicht bindend. Für Informationen zu den Daten der Codenummern, Verpackungen und Gewichten siehe immer die neuste, jeweils gültige Preisliste.



Sichenia Gruppo Ceramiche S.p.A.

Via Toscana, 12 - 41049 Sassuolo (Modena) - Italy
Tel. +39 0536.81.84.11 - Fax Italia +39 0536.81.01.05 / export +39 0536.80.08.15

info@sichenia.it - www.sichenia.it